

SLC Series Combination Display Units

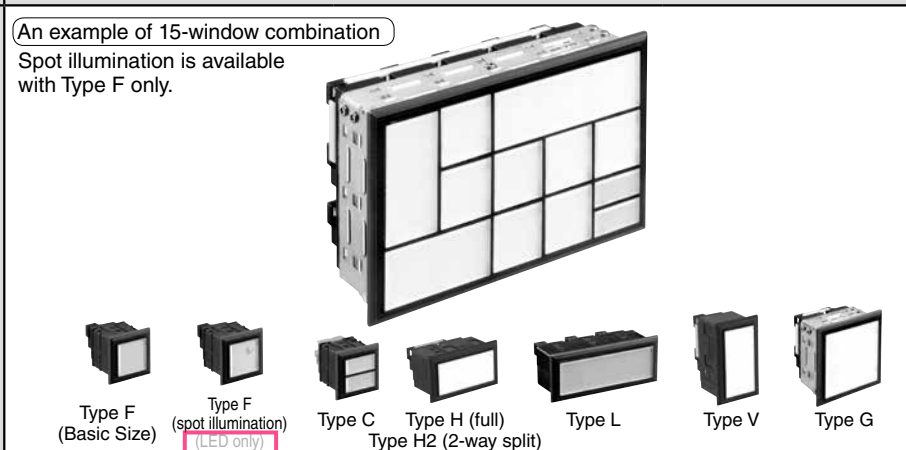

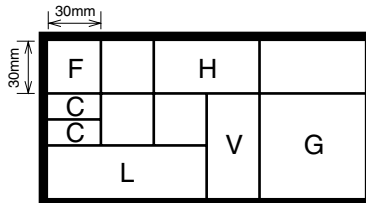







SLC30/40 series Combination Display Lights Selection Guide

Series	SLC Series Combination Display Lights			
Model	SLC30			
Shape	<p>An example of 15-window combination</p> <p>Spot illumination is available with Type F only.</p> 			
Light Source	LED Unit	LED lamp (LFTD) (SX6S/8 base)	Incandescent Lamp (LS) (BA9S/13 base, 1W)	
No. of Units	Basic (Type F) 1 for 1 window	Half Size (Type C) 1 for 1 window	Basic (Type F) 1 for 1 window	
Illumination Face Size	F, H, L, V, G	C only	F, H, L, V, G	
			Type F (30 × 30mm) Type H (30 × 60mm) Type L (30 × 90mm) Type V (60 × 30mm) Type G (60 × 60mm) Type C (15 × 30mm) (split-window)	
Illumination Color	A (amber), G (green), PW (pure white) *, R (red), S (blue), W (white), Y (yellow), Red (R)/G (green) * PW is available with Type F only	A (amber), G (green), PW (pure white), R (red), S (blue), W (white), Y (yellow)	A (amber), G (green), R (red), S (blue), W (white), Y (yellow)	
Rated Voltage	6, 12, 24V AC/DC (full voltage) 100/110, 200/220V AC (transformer) 110V DC (DC-DC converter) 100/110V AC/DC (resistor)	6, 12, 24V AC/DC (full voltage)	6, 12, 24V AC/DC (full voltage) 100/110, 200/220V AC (transformer) 100/110V AC/DC (resistor)	
Lens Frame Color & Frame Cover Color	Black (Munsell N1.5 equivalent)			
Terminal Screw	M3.5 Incandescent resistor: M4 nut 2-color illumination, Type C, Check terminal: M3			
No. of Windows	Full Voltage	1 to 200 (Type F equivalent)	1 to 50 (Type F equivalent)	1 to 200 (Type F equivalent)
	Transformer/Resistor	1 to 75 (Type F equivalent)	—	1 to 50 (Type F equivalent)
	Flasher/DC-DC Converter			—
Degree of Protection	IP40 (IEC 60529)			
Remarks	<ul style="list-style-type: none"> Jumper available 2-color alternate, check terminal, flasher (LED illuminated only) 			
Approvals	UL, c-UL, DEMKO, CE (Note)	—		
Page	5			

Note: Except for DC-DC converter and resistor

SLC30/40 Series Combination Display Lights Selection Guide

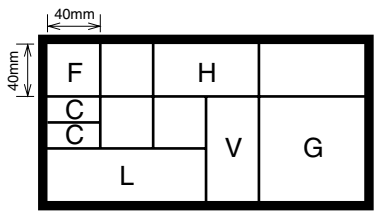
SLC Series Combination Display Lights				
SLC40				
<p>An example of 12-window combination</p> <p>Spot illumination is available with Type F only.</p>  <div style="display: flex; justify-content: space-around; align-items: flex-end; margin-top: 10px;"> <div style="text-align: center;">  <p>Type F (Basic Size)</p> </div> <div style="text-align: center;">  <p>Type F (spot illumination) (LED only)</p> </div> <div style="text-align: center;">  <p>Type C</p> </div> <div style="text-align: center;">  <p>Type H</p> </div> <div style="text-align: center;">  <p>Type L</p> </div> <div style="text-align: center;">  <p>Type V</p> </div> <div style="text-align: center;">  <p>Type G</p> </div> </div>				
LED Unit	LED lamp (LSTD) (BA9S/13 base)	Incandescent Lamp (LE) (E12/15 base, 2W)	Incandescent Lamp (LS) (BA9S/13 base, 1W)	
Basic (Type F) 1 for 1 window	Half Size (Type C) 1 for 1 window	Basic (Type F) 1 for 1 window	Basic (Type F) 2 for 1 window	
F, H, L, V, G	C only	F, H, L, V, G	F only	
		<p>Type F (40 × 40mm) Type H (40 × 80mm) Type L (40 × 120mm) Type V (80 × 40mm) Type G (80 × 80mm) Type C (20 × 40mm) (split-window)</p>		
A (amber), G (green), PW (pure white) *, R (red), S (blue), W (white), Y (yellow), Red (R)/G (green) * PW is available with Type F only	A (amber), G (green), PW (pure white), R (red), S (blue), W (white), Y (yellow)	A (amber), G (green), R (red), S (blue), W (white), Y (yellow)		
12, 24V AC/DC (full voltage) 100/110, 200/220V AC (transformer) 110V DC (DC-DC converter) 100/110V AC/DC (resistor)	6, 12, 24V AC/DC (full voltage)	6, 12, 18, 24V AC/DC (full voltage) 100/110, 200/220V AC (transformer) 100/110V AC/DC (resistor)	6, 12, 18, 24V AC/DC (full voltage)	
Black (Munsell N1.5 equivalent)				
M3.5 Incandescent resistor: M4 nut 2-color illumination, Type C, Check terminal: M3				
1 to 126 (Type F equivalent)	1 to 105 (Type F equivalent)	1 to 105 (Type F equivalent)	1 to 105 (Type F equivalent)	
1 to 60 (Type F equivalent)	—	1 to 50 (Type F equivalent)	—	
IP40 (IEC 60529)				
<ul style="list-style-type: none"> Extensive windows are easy to recognize at high places. Jumper available 2-color alternate, flasher (LED illuminated only), check terminal, dual-lamp (incandescent lamp only) 				
UL, c-UL, DEMKO, CE (Note)	—			
15				

Note: Except DC-DC converter, resistor

SLC30/40 series Combination Display Lights Selection Guide

Series	Combination Display with Control Units	
Model	SLC30 Series (SLC30 + SLC-LW)	
Shape		
No. of Windows	<ul style="list-style-type: none"> Combination display lights: 29 maximum Control units: 10 maximum (the bottom row only) } Total 30 maximum	
Combination Display Lights	<ul style="list-style-type: none"> SLC30 series LED one-color (window 30 × 30mm) Illumination color: A (amber), G (green), PW (pure white), R (red), S (blue), W (white), Y (yellow) 	
Ratings	Rated voltage: 24V AC/DC Operating voltage: 24V AC/DC ±10%	
Control Unit	<ul style="list-style-type: none"> Pushbutton (square, round with square bezel, momentary) Illuminated pushbutton (square, round with square bezel, momentary) Selector switch (2, 3 positions, round with square bezel) Key selector switch (2, 3 positions, round with square bezel) 	
Contact Ratings (Resistive Load)	<ul style="list-style-type: none"> Rated insulation voltage: 250V AC/DC Rated current: 3A/gold, 5A/silver Gold contact: 125V AC/0.1A, 30V DC/0.1A Silver contact: 125V AC/3A, 250V AC/2A, 30V DC/2A, 125V DC/0.4A 	
Lens Frame Color & Frame Cover Color	Black (Munsell N1.5 equivalent)	
Degree of Protection	IP40 (IEC 60529)	
Page	40	

<IP65 Degree of Protection Pilot Lights>

The following control square flush pilot lights can be mounted collectively to design a panel similar to combination display lights.

SLC30 series equivalent
HW2P-1

Collective Mounting Example (HN2P)



Front



Back

Flange size	□30
Mounting hole	ø22
Degree of protection	IP65 (IEC 60529)

SLC30 series Combination Display Lights

Highly bright "Super LED" unit improves visibility and safety.

- Eight types of illumination faces to choose from. Compact combination display lights.
- Super bright Super LED.
- The fingersafe spring-up terminals reduce wiring time and prevent electrical shocks.
- The insulated jumper, when used on fingersafe spring-up terminals, eliminates the need of terminal cover.
- Legends can be engraved on the attached marking plate. One or two thin marking sheets (not attached) can also be installed (Type F only).
- Spot illumination available for easy recognition in bright environment (Type F only)
- UL and c-UL recognized, EN compliant.

Applicable Standards	Mark	File No. or Organization
UL508 CSA C22.2 No.14		UL/c-UL Recognized File No. E68961
EN60947-1 EN60947-5-1 (Note)		TÜV SÜD EU Low Voltage Directive

Note: Except for DC-DC converter and resistor types.

- A wide variety of illumination face sizes
- Type F: 30H x 30W mm (Basic size)
 - Type F spot illumination: 30H x 30W mm
 - Type C: 15H x 30W mm x 2 (Split-window)
 - Type H: 30H x 60W mm
 - Type H2: 30H x 60W (2-way split)
 - Type L: 30H x 90W mm
 - Type V: 60H x 30W mm
 - Type G: 60H x 60W mm
- Combined construction is available.

Type F Window Spot Illumination Kit

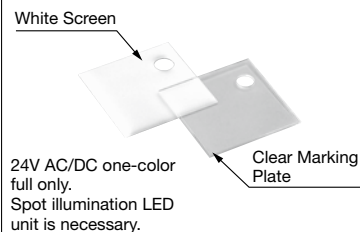

Frame (metal)
The frame cover and frame are molded in one piece for one-, two-, and three-window types.



Choice of LED or incandescent illumination

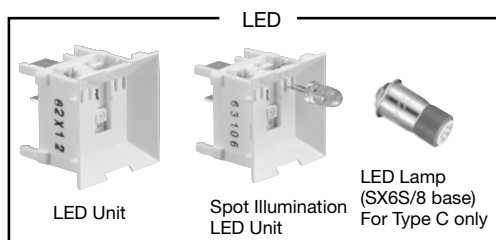

An Example of 15-window size

Spot illumination is available with type F only.

Type F Type F (spot illumination) (LED only) Type C (split-window) Type H (full) Type H2 (2-way illumination) Type L Type V Type G

The fingersafe, spring-up terminals reduce wiring time.

The integrated terminal cover and insulated jumpers prevent electric shocks.

Application Example of Jumpers

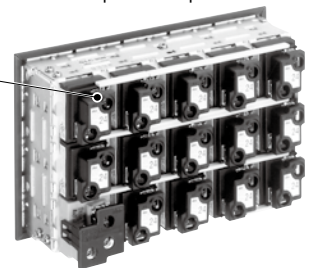

Marking films can be used for Type F only

Available up to 200 windows

LED: 10 rows by 26 columns maximum

Incandescent: 10 rows by 20 columns maximum

(Type F - LED illumination: 6, 12, 24V AC/DC

Incandescent illumination: 6, 12, 18, 24V AC/DC

See page H-36 for details.

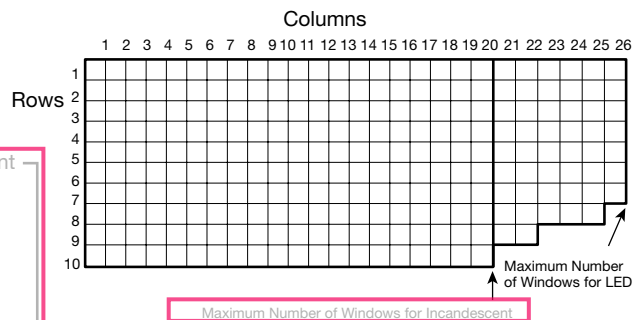

- For LED illuminated 110/220V AC type, up to 75 windows (Type F equivalent) can be mounted.
- For incandescent illuminated 110/220V AC type and for Type C, up to 50 windows (Type F equivalent) can be mounted.
- Lighting limitations should be considered in any application. For details see page 32.

SLC30 Series Combination Display Lights

Configuration

LED Illuminated

Illumination Face

Incandescent Illuminated

• See page 34 for the combination of illumination windows.

• Lens (acrylic)

• Marking Plate (acrylic) (clear, white, color)

• Lens Frame (resin)

Spot Illumination (LED illuminated only)

Type F

Type C

Type H
Type H2

Type L

Type V

Type G

• Lens (acrylic)

• Marking Plate (acrylic) (clear, white, color)

• Lens Frame (resin)

Type F, H, H2, L, V, G

Display Color Type	Light Source	Marking Plate/Color Screen (one each) (Note 3)	Lens	ON Color (Color Code)		OFF Color
Standard (using clear lens)	LED Unit	clear / white	Clear Lens	amber (A), blue (S), green (G), pure white (PW) (Note 1), red (R), white (W), yellow (Y), red/green 2-color alternate (RG) (Note 2)		White
	Incandescent Lamp	color / white clear / white		amber (A), blue (S), green (G), red (R), yellow (Y), white (W)		
Color Screen	LED Unit	color / white	Gray Lens	amber (TA), blue (TS), green (TG), pure white (TPW), red (TR), white (TW), yellow (TY)		Same as ON color
Gray Lens	LED Unit	black (Note 4) / clear		Lens: gray	Legend Color	amber (SA), blue (SS), green (SG), pure white (SPW) (Note 1), red (SR), white (SW), yellow (SY)
	Incandescent Lamp			white (SW)		

- Note 1: Pure white (PW) is available with Type F only.
- Note 2: Spot illumination is not available with red/green 2-color alternate (RG).
- Note 3: The order to insert clear marking plate, color screen, and white screen can be interchanged if necessary. Marking plate/color screen are interchangeable. Engrave markings on the flat surface of the plate or screen next to the lens.
- Note 4: Black marking plate has black coating. Engrave a reverse legend on the black-coated surface.

Type C (split-window)

Display Color Type	Light Source	Marking Plate/Color Screens (one each)(Note 1)	Lens	ON Color (Color Code)		OFF Color
Standard (using clear lens)		color / white	Clear Lens	amber (A), blue (S), green (G), red (R), yellow (Y),		White
		clear / white		pure white (PW), white (W)		
Gray Lens	LED Lamp	black (Note 2) / color	Gray Lens	Lens: gray	amber (SA), blue (SS), green (SG), red (SR), yellow (SY),	Gray
		black (Note 2) / clear		Legend Color	pure white (SPW), white (SW)	

- Note 1: The order to insert clear marking plate, color screen, and white screen can be interchanged if necessary. Marking plate/color screen are interchangeable. Engrave markings on the flat surface of the plate or screen next to the lens.
- Note 2: Black marking plate has black coating. Engrave a reverse legend on the black-coated surface.



• LED Unit



• LED Unit for Spot Illumination



• LED Lamp (for Type C only, SX6S/8 base) (2 lamps for 1 window equivalent to Type F)



• Incandescent Lamp (BA9S/13 base)

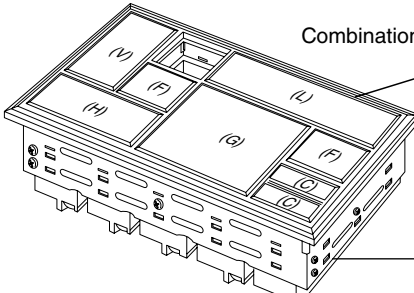



Combination Example of 15 Windows

Frame Cover Black (B)

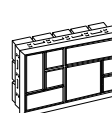
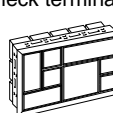
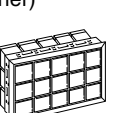
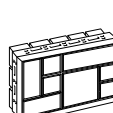
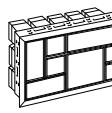
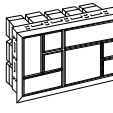
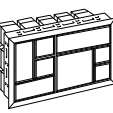
Mounting Clip SLC-3K1 (supplied)

LED Illuminated			
One-color full  6, 12, 24V AC/DC	One-color full (w/check terminal)  24V DC (Except Type C)	One-color full (Flasher)  24V DC (Type F only)	Two-color Alternate  24V AC/DC (Except Type C)
One-color full  100/110V, 200/220V AC (Except Type C)	One-color full  100/110V DC (Resistor Type) (Except Type C)	One-color full  110V DC (DC-DC Converter) (Except Type C)	

- 2-way split is also available in Type H2.
- The illustration above shows combination examples of windows. One-window type is available in Type F (see page 10 and 11).

Incandescent Illuminated
One-color full  6, 12, 18, 24V AC/DC (Except Type C)
One-color full  100/110, 200/220V AC (Except Type C)
One-color full  100/110V AC/DC (Resistor) (Except Type C)

SLC30 series Combination Display Lights

Specifications

LED Illuminated

Light Source		LED Unit							LED Lamp			
Input	Full Voltage				Transformer	DC-DC Converter	Resistor	Full Voltage				
Illumination	One-color One-color w/check terminal (Note 1)		Two-color Alternate	Flasher	One-color			One-color × 2 Split-window (Type C)				
Fingersafe Spring-up Terminal	Provided (except for check terminal)		(Note 2)	Provided	Provided			(Note 2)				
Rated Voltage (AC: 50/60Hz)	6V AC/DC ±5%	12V AC/DC ±10%	24V AC/DC ±10%	24V AC/DC ±10%	24V DC ±10%	100/110V AC ±10% 200/220V AC ±10%	110V DC (90 to 140V DC)	100/110V AC/DC ±10%	6V AC/DC ±10%	12V AC/DC ±10%	24V AC/DC ±10%	
Maximum Current Draw (VA)	Same as internal LED Unit				0.5W + internal LED	1.7	1.4	1.5	Same as internal LED			
Illumination Color	Amber, green, red, white, yellow		Amber, blue, green, pure white, red, white, yellow	Red/green Alternate	Amber, blue, green, pure white, red, white, yellow			Amber, blue, green, pure white (Note 8), red, white, yellow				
Standards	UL, c-UL listed, EN compliant							—		—		
Built-in LED Unit/Lamp	Rated Voltage	6V AC/DC	12V AC/DC	24V AC/DC	24V DC	24V AC/DC			6V AC/DC	12V AC/DC	24V AC/DC	
	Rated Current	Amber, red	12 mA	12 mA	12 mA (Note 6)	12 mA (Note 6)			7 mA (Note 7)	8 mA (Note 7)	8 mA (Note 7)	
		White	21 mA	12 mA	12 mA (Note 6)	12 mA (Note 6)						
		Blue, green, pure white, yellow	12 mA	12 mA	11 mA (Note 6)	11 mA (Note 6)						
Illumination Color (code)	Amber (A), blue (S), green (G), red (R), pure white (PW), white (W), yellow (Y) (Note 5)			Red (R)/green (G)	Amber (A), blue (S), green (G), pure white (PW), red (R), white (W), yellow (Y)			Amber (A), blue (S), green (G), pure white (PW), red (R), white (W)				
Base	Plug-in unit type							SX6S/8				
LED Life (reference)	Approx. 50,000 hours (when used on complete DC, luminance reduces to 50% of the initial intensity)											
Part No.	SLDN-36M-*	SLDN-31M-*	SLDN-32M-*	SLDN-32MW-RG	SLDN-32M-*			LFTD-6*	LFTD-1*	LFTD-2*		
No. of Units	1 LED unit per window of basic Type F							1 LED lamp per split-window type				
Flashing Period (Note 3)	—				0.5 ±0.2 sec	—			—			
Insulation Resistance	100 MΩ between live and dead parts (500V DC megger)											
Dielectric Strength	2000V AC (1 minute) between live and dead parts				2500V AC (1 minute) between live and dead parts			2000V AC (1 minute)	2000V AC (1 minute) between live and dead parts			
Operating Temperature (Note 4)	-20 to +40°C				-10 to +40°C	-20 to +40°C	-10 to +40°C	-20 to +40°C	-20 to +40°C			
Storage Temperature	-25 to +60°C (no freezing)											
Operating Humidity	45 to 85% RH (no condensation)											

Specify a color code in place of *.

Note 1: The rated voltage for w/check terminal type is 24V DC only.

Note 2: Terminal cover is available (see page 26).

Note 3: Duty 1:1. Multiple flasher type units do not synchronize with each other.

Note 4: No freezing. Use Type F only.

Note 5: Blue and pure white LED is 24V AC/DC only.

Note 5: Blue and pure white LED is 24V AC/DC only.

Note 6: Spot illumination uses the spot illumination LED unit (SLCN-32ST*). See page 29 for rated current.

Note 7: Rated current for DC. See page 29 for AC.

Note 8: Use pure white LED lamp for yellow (Y) illumination.

Incandescent Illuminated

Illumination		One-color Full Voltage				One-color Transformer	One-color Resistor
Rated Voltage (AC: 50/60Hz)	6V AC/DC	12V AC/DC	18V AC/DC	24V AC/DC	100/110, 200/220V AC 50/60 Hz	100/110V AC/DC	
Illumination Color	Amber, blue, green, red, white, yellow						
Built-in Lamp	Rated Voltage	6.3V-1W lamp	18V-1W lamp	24V-1W lamp	30V-1W lamp	6.3V-1W lamp	18V-1W lamp
	Operating Voltage	5 to 6V	12 to 18V	18 to 24V	24 to 30V	5 to 6V	12 to 18V
	Base	BA9S/13					
	Lamp Life	Approx. 1,000 hours minimum (mean value when used on the rated voltage)					
Part No.	LS-6	LS-8	LS-2	LS-3	LS-6	LS-8	
No. of Lamps	1 lamp per window of basic Type F						
Insulation Voltage	100 MΩ between live and dead parts (500V DC megger)						
Dielectric Strength	2000V AC (1 minute) between live and dead parts				2500V AC (1 minute) between live and dead parts	2000V AC (1 minute) between live and dead parts	
Operating Temperature	-20 to +40°C (no freezing)						
Storage Temperature	-25 to +60°C (no freezing)						
Operating Humidity	45 to 85% RH (no condensation)						

Terminal cover is available for all incandescent illuminated types (see page 26), except for the resistor type.

LED/Incandescent Illuminated

Illumination Face		Type F (Note 1, 2) (Basic)	Type C (Split-window)	Type H / Type H2 (Note 3)	Type L	Type V	Type G
Illumination Unit Size (mm)	Window (H × W)	30 × 30	15 × 30	30 × 60	30 × 90	60 × 30	60 × 60
	Illumination Face (H × W)	28 × 28	13 × 28	28 × 58	28 × 88	58 × 28	58 × 58
	White color screen, clear marking plate, color screen (H × W × t)	27 × 27 × 1.0	12 × 27 × 1.0	27 × 57 × 1.0 (Note 2)	27 × 87 × 1.0	57 × 27 × 1.0	57 × 57 × 1.0
	Marking Film	Applicable	—	—	—	—	—
	Engraving Area (white, transparent, color plates)	25 × 25	10 × 25	25 × 55	25 × 85	55 × 25	55 × 55
Material of Marking Plate & Color Screen	Acrylic						
Lens Frame Color & Frame Cover Color	Black (Munsell N1.5 equivalent)						
Connection Wire	Solid wire: ø1.6 × 2, Stranded 2 mm ² × 2						
Terminal Screw	M3.5 screw, Incandescent resistor: M4 nut, Check terminal: M3						
Degree of Protection	IP40 (IEC 60529)						
Pollution Degree	3						

Note 1: Flasher type, pure white illumination, and spot illumination types are available in Type F only.

Note 2: Spot illumination uses designated clear plate and color screen.

Note 3: 2-way split type (Type H2) can use 2-way split color screen only.

SLC30 Series Combination Display Lights

Dimensions

[Front View] a: No. of Rows b: No. of Columns

Type F

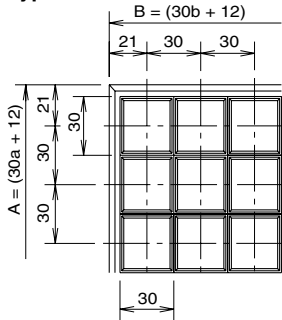

Type F (Spot Illumination)

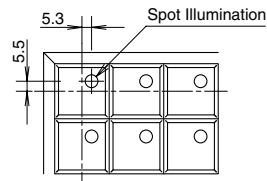

Type H

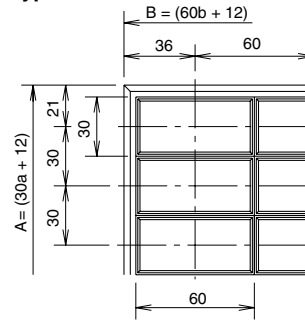

Type H2 (2-way split)

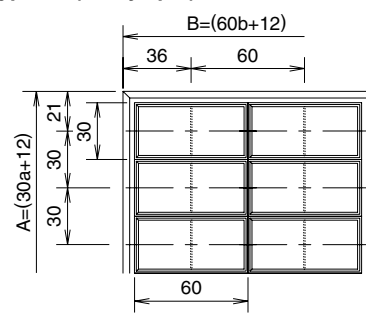

Type V

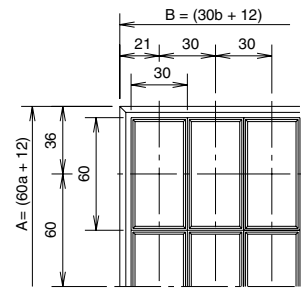

Type L

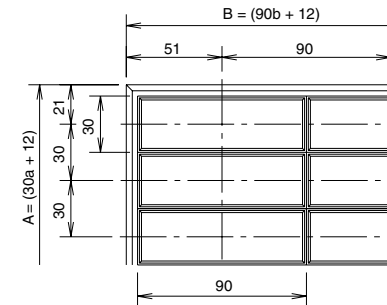

Type G

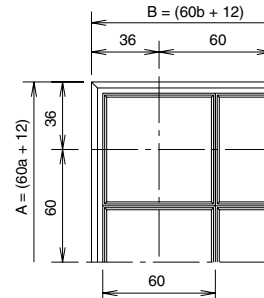

Type C (split-window)

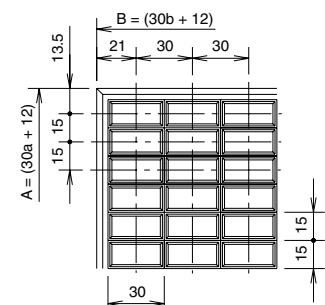

All dimensions in mm.

Type F Dimensions & No. of Windows (Type C, H, L, V, and G can be converted into Type F.)

Columns	b	01	02	03	04	05	06	07	08	09	10	11	12	13	14	15	16	17	18	19	20	21	22	23	24	25	26
Rows	Dimensions B	42	72	102	132	162	192	222	252	282	312	342	372	402	432	462	492	522	552	582	612	642	672	702	732	762	792
	Panel Cut-out (D)	(35)	(65)	(95)	(125)	(155)	(185)	(215)	(245)	(275)	(305)	(335)	(365)	(395)	(425)	(455)	(485)	(515)	(545)	(575)	(605)	(635)	(665)	(695)	(725)	(755)	(785)
a	A (C)																										
01	42 (35)	1	2	3	4	5	6	7	8	9	10	11	12	13	14	15	16	17	18	19	20	21	22	23	24	25	26
02	72 (65)	2	4	6	8	10	12	14	16	18	20	22	24	26	28	30	32	34	36	38	40	42	44	46	48	50	52
03	102 (95)	3	6	9	12	15	18	21	24	27	30	33	36	39	42	45	48	51	54	57	60	63	66	69	72	75	78
04	132 (125)	4	8	12	16	20	24	28	32	36	40	44	48	52	56	60	64	68	72	76	80	84	88	92	96	100	104
05	162 (155)	5	10	15	20	25	30	35	40	45	50	55	60	65	70	75	80	85	90	95	100	105	110	115	120	125	130
06	192 (185)	6	12	18	24	30	36	42	48	54	60	66	72	78	84	90	96	102	108	114	120	126	132	138	144	150	156
07	222 (215)	7	14	21	28	35	42	49	56	63	70	77	84	91	98	105	112	119	126	133	140	147	154	161	168	175	182
08	252 (245)	8	16	24	32	40	48	56	64	72	80	88	96	104	112	120	128	136	144	152	160	168	176	184	192	200	—
09	282 (275)	9	18	27	36	45	54	63	72	81	90	99	108	117	126	135	144	153	162	171	180	189	198	—	—	—	—
10	312 (305)	10	20	30	40	50	60	70	80	90	100	110	120	130	140	150	160	170	180	190	200	—	—	—	—	—	—

How to Read the Table

- The number of windows equals rows multiplied by columns. For example, for 5 rows by 7 columns, the number of windows is 35, external dimensions are 162mm high by 22mm wide, and panel cut-out is 155mm high by 215mm wide.
- External dimensions are represented by A for rows and B for columns in boldface.
- Panel cut-out dimensions are shown in (), for height (C) and width (D). Panel cut-out tolerance is +1.0 to -0 mm (for one window: +0.6 to -0.4mm).

Panel Cut-out (SLC30)

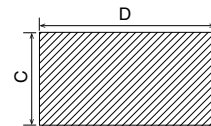

Determine the panel thickness in consideration of the weight of display lights and wires (see page 26).

[Example]

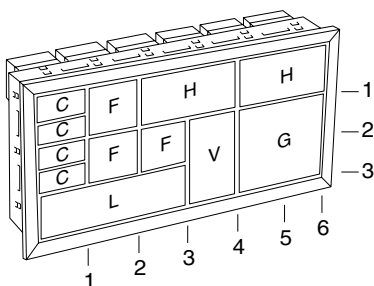

- Total number of windows, dimensions, panel cut-out
- For Type C, H, L, V, and G, convert the numbers of rows and columns into Type F (basic size) equivalents.

- Type C — Type F equivalent: 2 split-windows consist of one window.



- Type H — Type F equivalent: 2 windows
Height: 1 row
Width: 2 columns



- Type V — Type F equivalent: 2 windows.
Height: 2 rows
Width: 1 column



- Type L — Type F equivalent: 3 windows
Height: 1 row
Width: 3 columns



- Type G — Type F equivalent: 4 windows
Height: 2 rows
Width: 2 columns



- The combination example at left consists of 3 rows by 6 columns.
- The above table shows: No. of windows: 18
Dimensions: 102H x 192W mm
Panel cut-out: 95H x 185W mm

SLC30 Series Combination Display Lights

Dimensions

LED Illuminated [Side & Rear Views]

Type F (Type H, L, V, and G are the same in side and rear views as Type F.)

- Full Voltage
- 6, 12, 24V AC/DC
- One-color full
- Spot Illumination 24V AC/DC

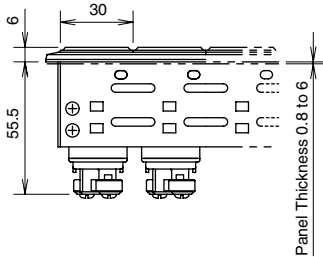

- Full Voltage
- One-color full w/Check Terminal 24V DC
- Two-color alternate 24V AC/DC
- For applicable terminal cover, see page 26.

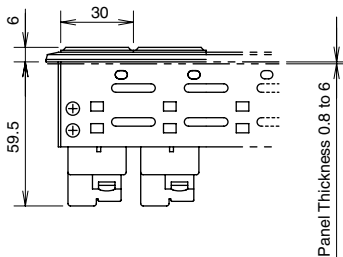

- Full Voltage
- One-color full
- Flasher Type (Type F only)
- For applicable terminal cover, see page 26.

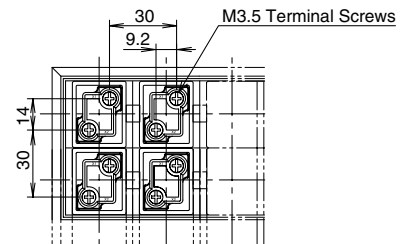
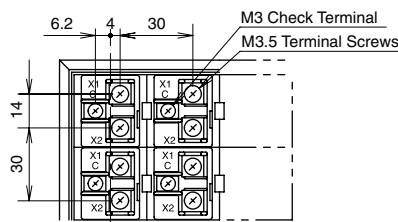
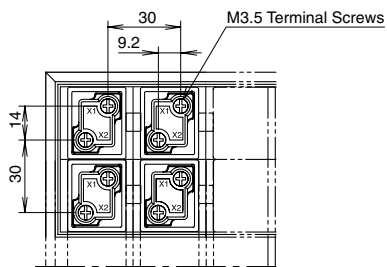
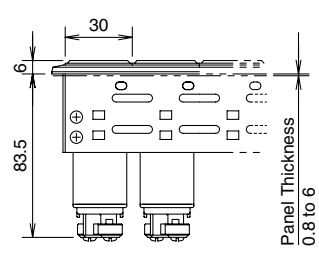

- w/Check Terminal
Terminal X1 is a positive pole; Terminal X2 and C (check terminal) are negative poles.
- Two-color Alternate
Red (R) illumination: X1 positive, C negative
Green (G) illumination: X1 positive, X2 negative

- Terminals X1 and X2 are positive and negative poles, respectively.

- Transformer
- One-color full
- 100/110, 200/220V AC/DC
- 110VDC (DC-DC Converter)

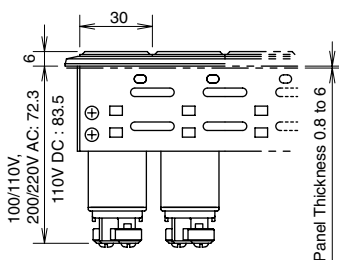

- Resistor
- One-color full
- 100/110V AC/DC

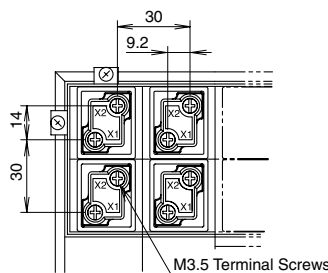
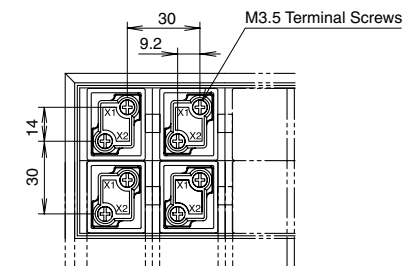
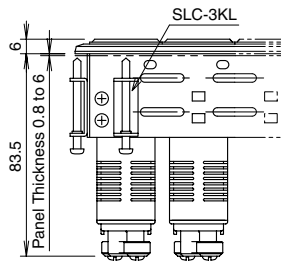

- On LED illuminated DC-DC Converter type units, Terminals X1 and X2 are positive and negative poles, respectively.

Type C (split-window)

- Full Voltage
- 6, 12, 24V AC/DC
- One-color full, 2 x LED lamps, Split-window type

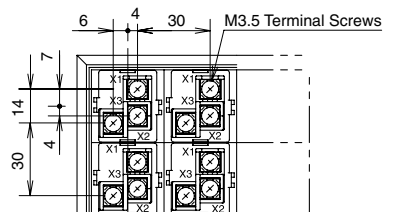
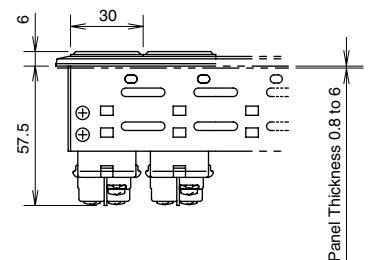

- Terminal X1 is COM terminal.
- For applicable terminal cover, see page 26.

All dimensions in mm.

SLC30 Series Combination Display Lights

Dimensions

LED Illuminated [One-window, Type F only] Full Voltage 6, 12, 24V AC/DC, One-color Full

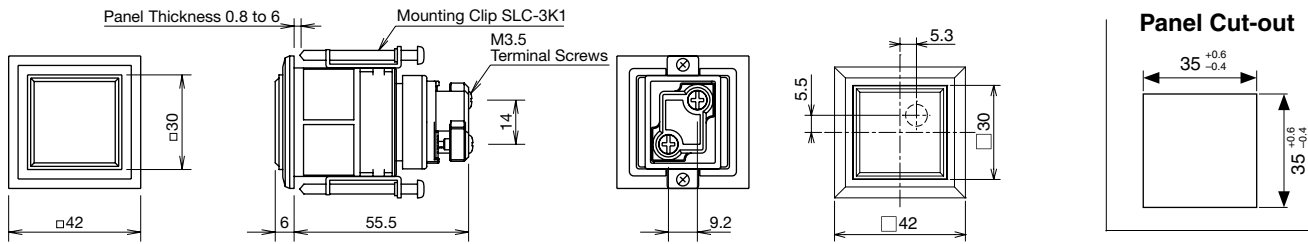

Full Voltage w/Check Terminal 24V DC / Two-color Alternate 24V AC/DC

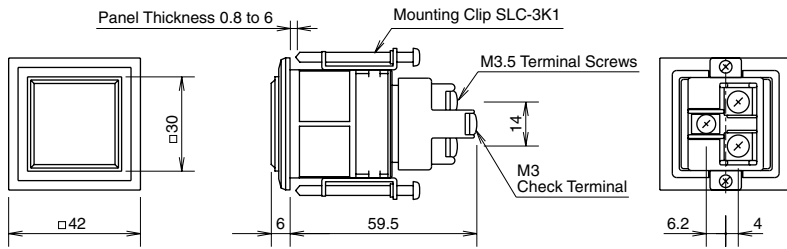

- w/Check Terminal Type
Terminal X1 is a positive pole; Terminals X2 and C (check terminal) are negative poles.
- Two-color Alternate Type
Red (R) illumination: X1 positive, C negative
Green (G) illumination: X1 positive, X2 negative
- See page 26 for terminal covers.

Flasher 24V DC

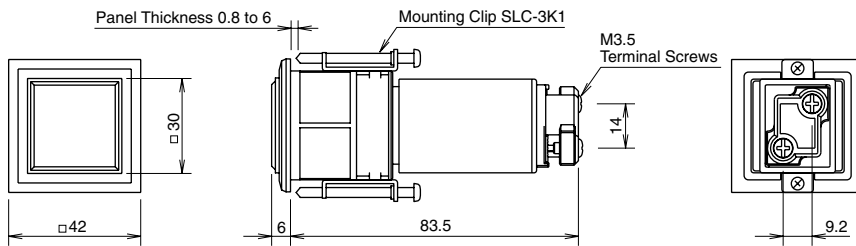

- On LED illuminated flasher type, Terminals X1 and X2 are positive and negative poles, respectively.
- See page 26 for terminal covers.

Transformer 100/110, 200/220V AC

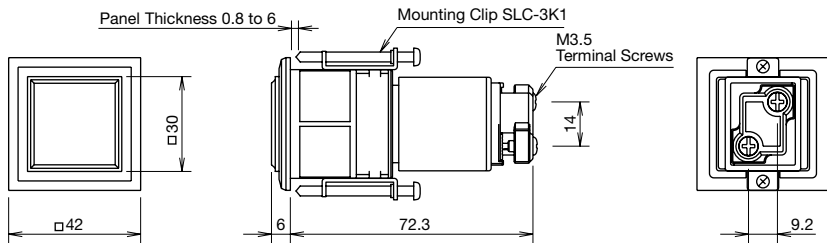

DC-DC Converter 110V DC

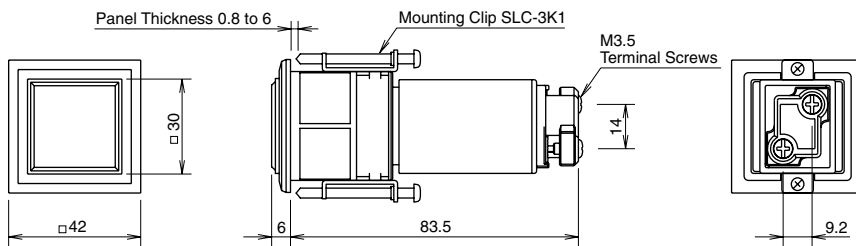

- On LED illuminated DC-DC converter type, Terminals X1 and X2 are positive and negative poles, respectively.

Resistor 100/110V AC/DC

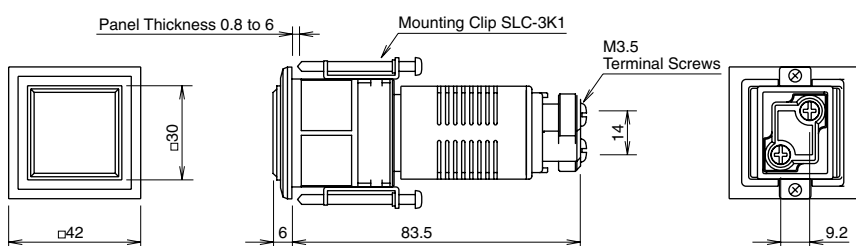

(Resistance)
LED illuminated type: 72 kΩ, 4W

All dimensions in mm.

SLC30 series Combination Display Lights

Dimensions

Incandescent Illuminated [Side & Rear Views]

- Full Voltage
- 6, 12, 18, 24V AC/DC
- One-color full

- Transformer
- 100/110, 200/220V AC

- Resistor
- 110V AC/DC

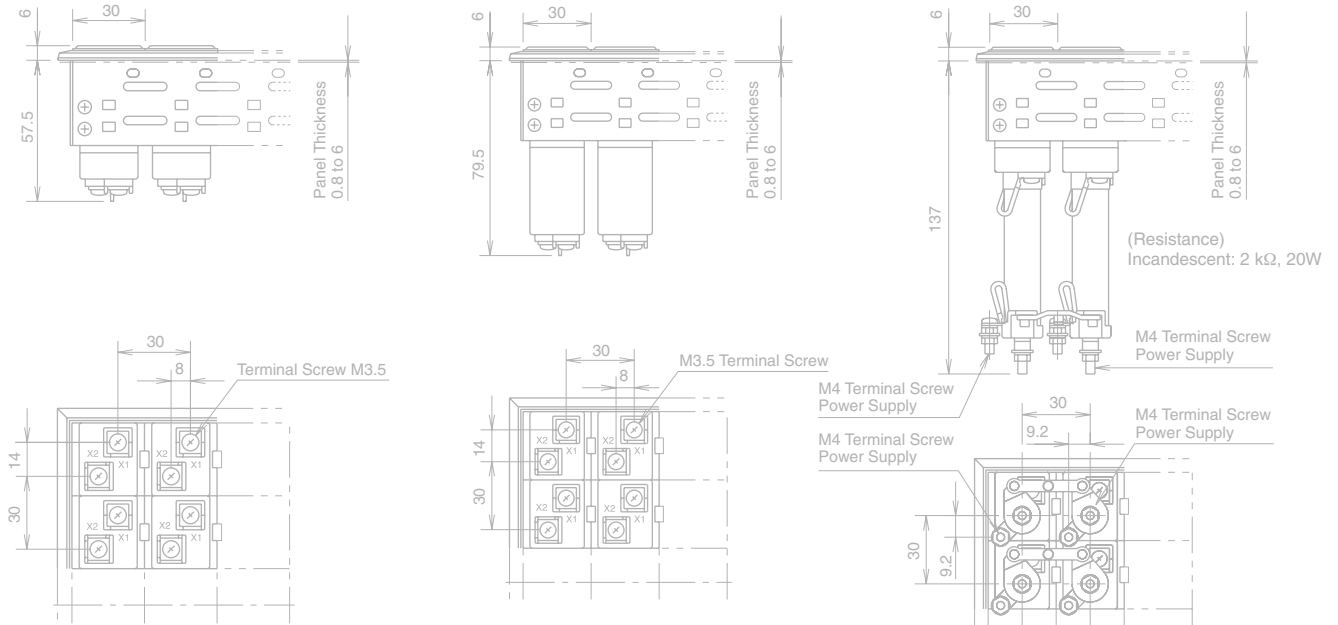

• Terminal cover is available. For dimensions, see page 26.

Incandescent Illuminated [One-window, Type F only]

Full Voltage 6, 12, 18, 24V AC/DC, One-color Full

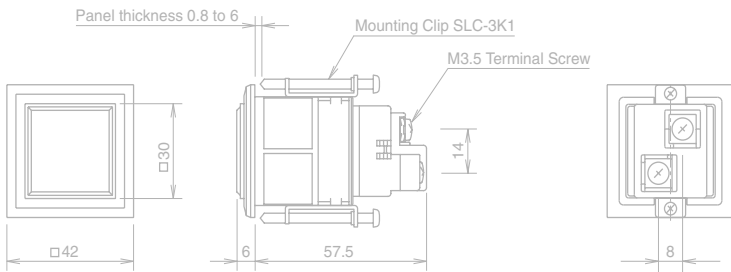

Panel Cut-out

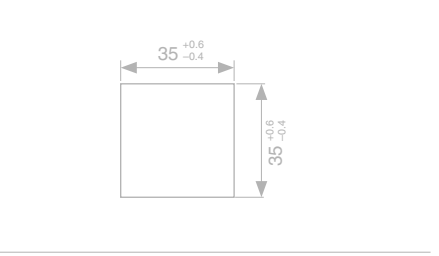

Transformer 100/110, 200/220V AC

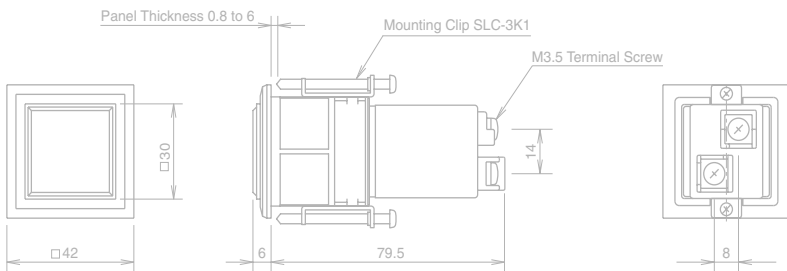

Resistor 100/110V AC/DC

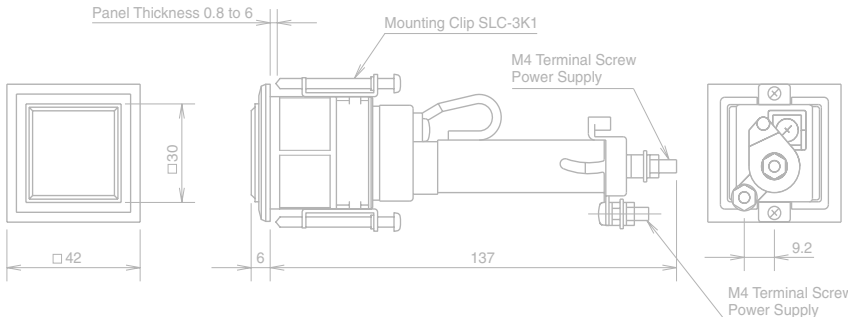

(Resistance)
Incandescent: 2 kΩ, 20W

All dimensions in mm.

SLC30 series Combination Display Lights

Terminal Connection (LED Illuminated)

- For one-color full LED illuminated with check terminal, DC-DC converter, and resistor, Terminals X1 and X2 are positive and negative poles, respectively.

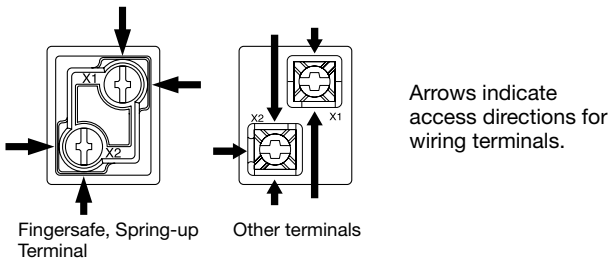

(Flasher Type Connection Diagram)

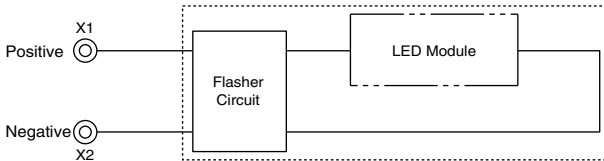

- For w/check terminal and two-color alternate units, terminal X1 is a positive pole; Terminals X2 and C (check terminal) are negative poles.

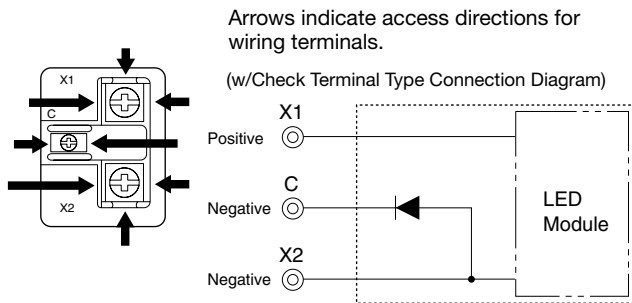

- Connection for two-color alternate is as follows.
Red (R) — Terminal X1: positive, Terminal C: negative
Green (G) — Terminal X1: positive, Terminal X2: negative

(Two-color alternate Type Connection Diagram)

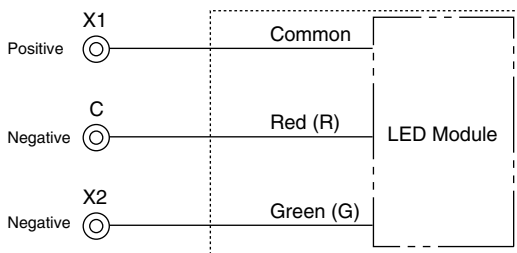

- For the LED illuminated split-window (Type C), Terminal X1 (+) is a common terminal. Terminal X2 is a negative pole of upper illumination and Terminal X3 is a negative pole of lower illumination. (AC/DC, except for LFTD-5*)

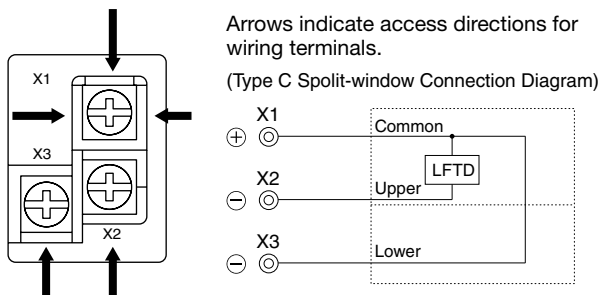

Terminal Connection Using Jumpers

- For terminal connection of types F, H, L, V, and G (except Type C), jumpers can be used as shown below.

SLC30 Series

	Terminal X1	Terminal X2	Terminal C	
LED Illuminated (Note 2)	Fingersafe, Spring-up Terminal (Note 1)	SLCN-JP34 SLCN-JP35	SLCN-JP34 SLCN-JP35	—
	Others	SLC-JP30	SLC-JP33	SLC-JP32
Incandescent Illuminated	SLC-JP30	SLC-JP33	SLC-JP32	

Note 1: fingersafe, spring-up terminals are used in one-color full illuminated type (6, 12, 24V AC/DC, 100/110, 200/220V AC, 110V DC).

Note 2: No jumper is used on resistor type.

- For Type C, jumpers can be used on Terminal X1 only as shown below.

Direction	• When using Type C only • When using Type C and Two-color alternate
Vertical	SLC-JP33
Horizontal	SLC-JP30

Note: Jumpers cannot be used when using both Type C and fingersafe spring-up terminals.

[Examples of Using Jumpers]

LED Illuminated (Fingersafe Spring-up Terminal)

When connecting two windows

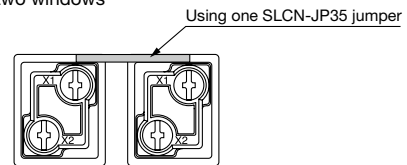

When connecting three windows

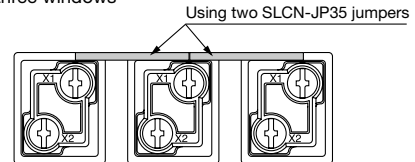

When connecting four windows

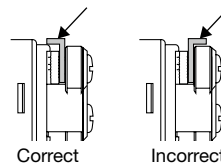
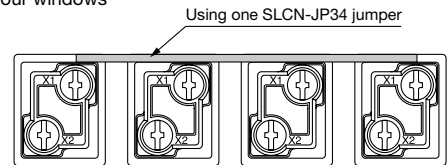

Jumpers (SLCN-JP34/35) have an orientation. Ensure that jumpers are installed correctly.

SLC30 Series Combination Display Lights

Part No. Development

SLC30N - 0405 - DD2FB - Example: G (5), R (5), W (10)
Specify the color code and the number of windows.

30 Series

When ordering Type H, L, V, G, or C units, enter the equivalents of Type F.

Frame Color
Black: B

Equivalent of Basic Size Windows	
Rows	Columns
01	01
02	02
03	03
04	04
05	05
06	06
07	07
08	08
09	09
10	10
11	
12	
13	
14	
15	
16	
17	
18	
19	
20	
21	
22	
23	
24	
25	
26	

Unit	(Code)	Operating Voltage (Built-in Lamp)	
		(Code)	(Code)
LED Illuminated LED Unit	Full Voltage (A, G, R, W, Y)	DD	6V AC/DC ±5% 6
			12V AC/DC ±10% 1
			24V AC/DC ±10% 2
			24V AC/DC ±10% 2
	Full Voltage (PW, S)	DDA	24V AC/DC ±10% 2
		DDC	24V AC/DC ±10% 2
	Full Voltage / Type H2 only (Combination of S and A, G, R, W, Y)	DHM	24V DC ±10% 2
		DH	24V DC ±10% 2
	Full Voltage w/Check Terminal (A, G, R, W, Y)	DW	24V AC/DC ±10% 2
		DF	24V DC ±10% 2
	Full Voltage Two-color Alternate (R/G)	TD	100/110V AC ±10% 1
		TDA	200/220V AC ±10% 2
	Transformer (A, G, R, W, Y)	TDC	100/110V AC ±10% 1
TDA		200/220V AC ±10% 2	
Transformer (PW, S)	TDC	100/110V AC ±10% 1	
	TDA	200/220V AC ±10% 2	
Transformer / Type H2 only (Combination of S and A, G, R, W, Y)	CD	110V DC (90 to 140V DC) 1	
	RN	100/110V AC/DC ±10% 1	
DC-DC Converter (A, G, R, W, Y)	DP	6V AC/DC ±10% (LFTD-6*) 6	
		12V AC/DC ±10% (LFTD-1*) 1	
Resistor (A, G, R, W, Y)		24V AC/DC ±10% (LFTD-2*) 2	
	Incandescent Illuminated LED Lamp	BA9S/13 Base	DS
			12 to 18V AC/DC (LS-8) 8
			18 to 24V AC/DC (LS-2) (Note 1) 2
			24 to 30V AC/DC (LS-3) 3
Transformer	TS		100/110V AC ±10% (LS-6) 1
			200/220V AC ±10% (LS-6) 2
			100/110V AC/DC ±10% (LS-8) 1
Resistor	RS		100/110V AC/DC ±10% (LS-8) 1

Illustration	Unit	Code
	Type F 30 × 30 mm	F
	Type H 30 × 60 mm	H
	Type H2 (Note 2) (2-way split) 30 × 60 mm	H2
	Type L 30 × 90 mm	L
	Type V 60 × 30 mm	V
	Type V 60 × 60 mm	G
	Type C (15 × 30 mm) × 2	C
	Type F Spot Illumination 30 × 30 mm	FST

Illumination Color	
Standard Clear Lens Combination	(Code)
Amber	A
Green	G
Pure White	PW
Red	R
Blue	S
White	W
Yellow	Y
Red / Green	RG

Color Screen Combination (LED only)		(Code)
Amber		TA
Green		TG
Pure White		TPW
Red		TR
Blue		TS
White		TW
Yellow		TY

Gray Lens Combination		(Code)
Amber		SA
Green		SG
Pure White		SPW
Red		SR
Blue		SS
White		SW
Yellow		SY

The following color/voltage selections are also available.

Unit	(Code)	Operating Voltage (Built-in Lamp)	
		(Code)	(Code)
LED Illuminated LED Unit	Full Voltage w/Check Terminal (PW, S)	DHMA	24V DC ±10% 2
		DFA	24V AC/DC ±10% 2
	Full Voltage Flasher (PW, S)	TD	115/120V AC ±10% 12
		TDA	230/240V AC ±10% 24
	Transformer (A, G, R, W, Y)	TDC	115/120V AC ±10% 12
		TDA	230/240V AC ±10% 24
	Transformer (PW, S)	TDC	115/120V AC ±10% 12
		TDA	230/240V AC ±10% 24
	Transformer / Type H2 only (Combination of S and A, G, R, W, Y)	CD	110V DC (90 to 140V DC) 1
		RNA	100/110V AC/DC ±10% 1
	DC-DC Converter (PW, S)	DPA	6V AC/DC ±5% (LFTD-6S) × 2 6
		DPC	12V AC/DC ±10% (LFTD-1S) × 2 1
	Resistor (PW, S)		24V AC/DC ±10% (LFTD-2S) × 2 2
Incandescent Illuminated LED Lamp		BA9S/13 Base	TS
			120V AC ±10% (LS-6) 12
Transformer	TS		230V AC ±10% (LS-6) 23
			240V AC ±10% (LS-6) 24
			380V AC ±10% (LS-6) 38
			400/440V AC ±10% (LS-6) 4
			480V AC ±10% (LS-6) 48

Note 1: For longer lamp life, LS-3 (30V rating, 1W) lamps are recommended when using on 24V AC/DC.

Note 2: Type H2 (2-way split) can be configured with the combination described below.

Left	Right
Standard Clear Lens	Standard Clear Lens
Color Screen	Color Screen
Gray Lens	Gray Lens

SLC30 Series Combination Display Lights

Ordering Information

When ordering SLC Series Combination Display Lights, use the specification sheet provided on page 39.

Designation Procedure

1. Part No.: Refer to Part No. Development Configuration on page 13.
2. Quantity: Enter the required number of identical assemblies.

Counting of Windows

Count the number of windows in the equivalent of Type F (basic size).

Leaf Spring (for one-window type only)

Leaf spring for temporary fastening is not attached, and can be supplied free of charge upon request when ordering (Part No. SLD44KVP).

[Conversion Rate]

- Type H (horizontal)

--	--

 Type F equivalent: 2 windows
Row (1), Column (2)
- Type L (horizontal)

--	--	--

 Type F equivalent: 3 windows
Row (1), Column (3)
- Type V (vertical)

 Type F equivalent: 2 windows
Row (2), Column (1)
- Type G (large)

 Type F equivalent: 4 windows
Row (2), Column (2)
- Type C (split-window)

--

 Type F equivalent: 1 window
Row (1), Column (1)

[Designation Examples]

Ex. 1 SLC30 Series
Type F, 20 windows

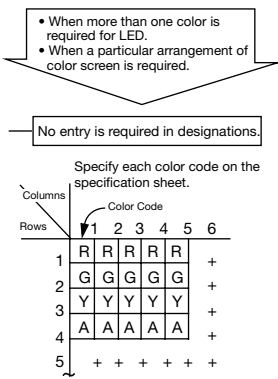
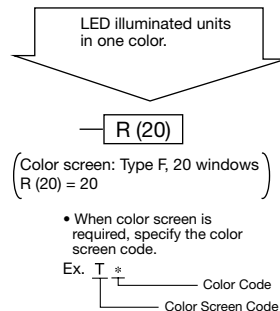
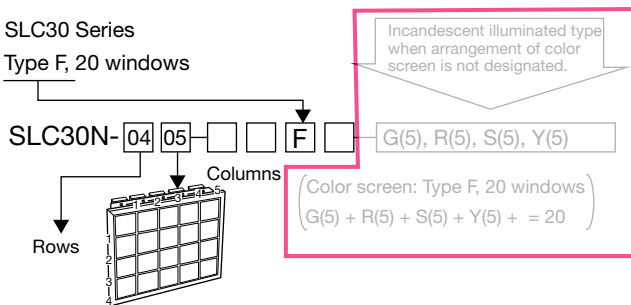

Ex. 2 SLC30 Series
Type H, 9 windows (Type F equivalent: 3 rows by 6 columns)

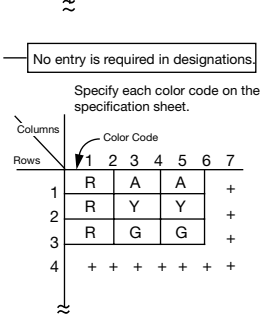
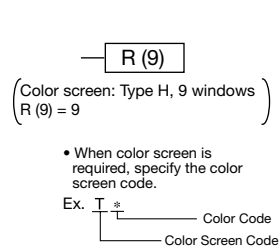
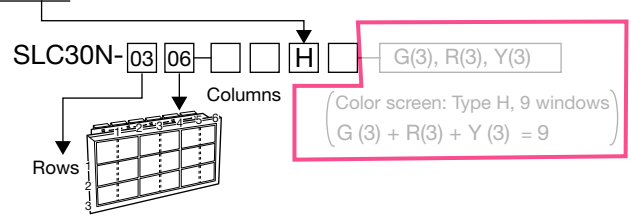

Ex. 3 SLC30 Series (Type F, 12 windows)

When ordering a combination of units with different operating voltages, specify Part No. as follows.

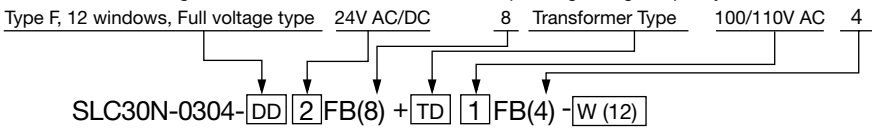

Specify the position of the units and each voltage on the specification sheet.

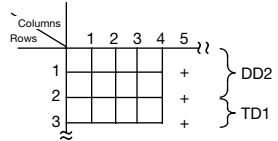

Ex. 4 When ordering a combination of units with different illumination colors, specify Part No. as follows.

Example: Full voltage LED illuminated 24V AC/DC, Red (6), Pure White (2)

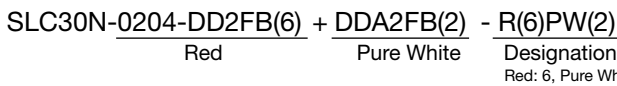

Specify the position of the units and each color code on the specification sheet.

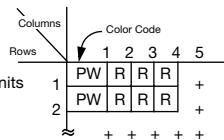

Ex. 5 When ordering a combination of units with different illumination colors for four windows of type C, specify Part No. as follows.

Example: Full voltage LED illuminated 24V AC/DC

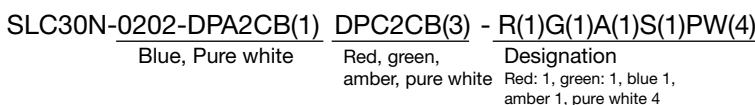

Specify the position of the units and each color code on the specification sheet.

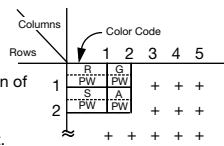

SLC40 Series Combination Display Lights

Highly bright "Super LED" unit improves visibility and safety.

- Eight types of illumination faces in 40mm size.
- Extensible window ensures high visibility when installed at high places (except C, L, G).
- Super bright Super LED.
- The fingersafe spring-up terminals save wiring time and prevent electrical shocks.
- The insulated jumper, when used on fingersafe spring-up terminals, eliminates the need of terminal cover.
- Legends can be engraved on the attached marking plate. One or two thin marking sheets (not attached) can also be installed (Type F only).
- Spot illumination available for easy recognition in bright environment (Type F only).
- UL and c-UL recognized, EN compliant (EN60947-5-1).

Applicable Standards	Mark	File No. or Organization
UL508 CSA C22.2 No. 14		UL/c-UL Recognized File No. E68961
EN60947-1 EN60947-5-1 (Note)		TÜV SÜD EU Low Voltage Directive

Note: Except for DC-DC converter and resistor types.

- A wide variety of illumination face sizes
- Type F: 40H × 40W mm (Basic size)
 - Type F spot illumination: 40H × 40W mm
 - Type C: 20H × 40W mm × 2 (Split-window type)
 - Type H: 40H × 80W mm
 - Type L: 40H × 120W mm
 - Type V: 80H × 40W mm
 - Type G: 80H × 80W mm
- Combined construction is available.

Type F Window Spot Illumination Kit

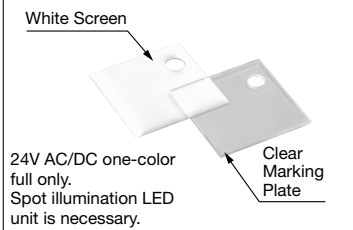

Frame (metal)
The frame cover and frame are integrated and molded of resin for Type F, one-window type.



Choice of LED or incandescent illumination

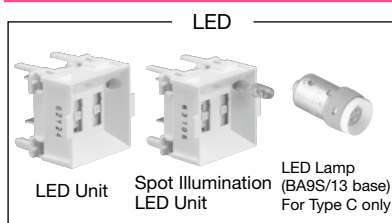

An Example of 12-window size

Spot illumination is available with type F only.



Extensible windows
Easy to recognize at high places (except Type C, L, and G)

The Fingersafe Spring-up terminals reduce wiring time. The integrated terminal cover and insulated jumpers prevent electric shocks.

Application Example of Jumpers

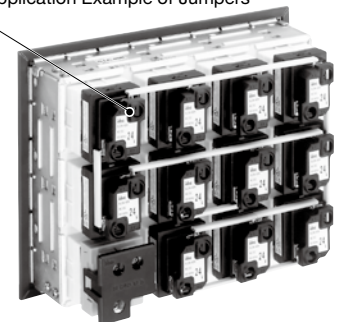

Split-window reduces installation space.

Available up to 126 windows
LED: 7 rows by 24 columns
LED illumination: 24V AC/DC
See page H-36 for details.

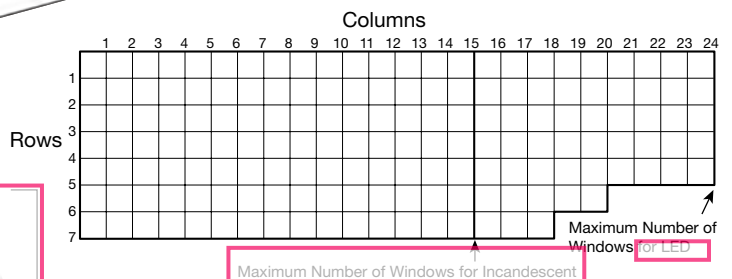

- For LED illuminated 110/220V AC type, up to 60 windows (Type F equivalent) can be mounted.
- For incandescent illuminated 110/220V AC type, up to 50 windows (Type F equivalent) can be mounted. For Type C, up to 105 windows (Type F equivalent) can be mounted.
- Lighting limitations should be considered in any applications. For details, see page 32.

SLC40 Series Combination Display Lights

Configuration

LED Illuminated

Illumination Face

Incandescent Illuminated

• See page 34 for the combination of illumination windows.

• Lens (acrylic)

• Marking Plate (acrylic) (clear, white, color)

• Lens Frame (plastic)

Type F

Type C

Type H

Type L

Type V

Type G

• See page 34 for details about lens combination.

• Lens (acrylic)

• Marking Plate (acrylic) (clear, white, color)

• Lens Frame (plastic)

Type F, H, L, V, G

Display Color Type	Light Source	Marking Plate/Color Screen (one each) (Note 1) (Note 3)	Lens	ON Color (Color Code)			OFF Color
Standard (using clear lens)	LED Unit	clear / white	Clear Lens	amber (A), blue (S), green (G), pure white (PW) (Note 1), red (R), white (W), yellow (Y), red/green 2-color alternate (RG) (Note 2)			White
	Incandescent Lamp	color / white		amber (A), blue (S), green (G), red (R), yellow (Y), white (W)			
Color Screen	LED Unit	color / white		amber (TA), blue (TS), green (TG), pure white (TPW), red (TR), white (TW), yellow (TY)			Same as ON color
Gray Lens	LED Unit	black (Note 4) / clear	Gray Lens	Lens: gray	Legend Color	amber (SA), blue (SS), green (SG), pure white (SPW) (Note 1), red (SR), white (SW), yellow (SY)	
	Incandescent Lamp	clear				white (SW)	

Note 1: Pure white (PW) is available with Type F only. Note 2: Spot illumination is not available with red/green 2-color alternate (RG).
 Note 3: The order to insert clear marking plate, color screen, and white screen can be interchanged if necessary.
 Marking plate/color screen are interchangeable. Engrave markings on the flat surface of the plate or screen next to the lens.
 Note 4: Black marking plate has black coating. Engrave a reverse legend on the black-coated surface.

Type C (split-window)

Display Color Type	Light Source	Marking Plate/Color Screen (one each) (Note 1)	Lens	ON Color (Color Code)			OFF Color
Standard (using clear lens)	LED Lamp	color / white	Clear Lens	amber (A), blue (S), green (G), red (R), yellow (Y).			White
		clear / white	Clear Lens	pure white (PW), white (W)			
Gray Lens	LED Lamp	black (Note 2) / color	Gray Lens	Lens: gray	Legend Color	amber (SA), blue (SS), green (SG), red (SR), yellow (SY), pure white (SPW), white (SW).	
		black (Note 2) / clear	Gray Lens			pure white (SPW), white (SW).	

Note 1: The order to insert clear marking plate, color screen, and white screen can be interchanged if necessary.
 Marking plate/color screen are interchangeable. Engrave markings on the flat surface of the plate or screen next to the lens.
 Note 2: Black marking plate has black coating. Engrave a reverse legend on the black-coated surface.



• LED Unit



• LED Unit for Spot Illumination



• LED Lamp (for Type C only, BA9S/13 base)
(2 lamps for 1 window equivalent to Type F)



• Incandescent Lamp (BA9S/13 base)



Incandescent Lamp (E12/15 base)

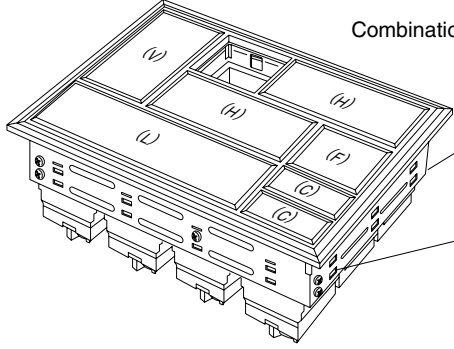

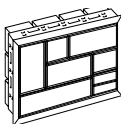
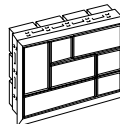
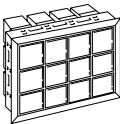
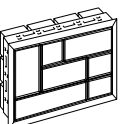
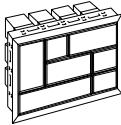
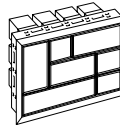
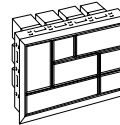

Combination Example of 12 Windows

- Frame Cover Black (B)
- Mounting Clip SLC-3K1 (supplied)

LED Illuminated			
 One-color full 24V AC/DC	 One-color full (w/check terminal) 24V DC (Except Type C)	 One-color full (Flasher) 24V DC (Type F only)	 Two-color Alternate 24V AC/DC (Except Type C)
 One-color full 100/110V, 200/220V AC (Except Type C)	 One-color full 100/110V DC (Resistor Type) (Except Type C)	 One-color full 110V DC (DC-DC Converter) (Except Type C)	

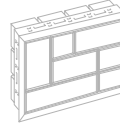
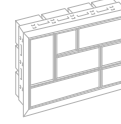
• The illustration above shows combination examples of windows. One-window is available in Type F.

Incandescent Illuminated	
 One-color full 6, 12, 18, 24V AC/DC (Except Type C)	 One-color full (w/check terminal) 100/110, 200/220V AC (Except Type C)
 One-color full 100/110V AC/DC (Resistor) (Except Type C)	

SLC40 Series Combination Display Lights

Specifications

LED Illuminated

Light Source		LED Unit						LED Lamp		
Input	Full Voltage			Transformer	DC-DC Converter	Resistor	Full Voltage			
Illumination	One-color One-color w/check terminal (Note 1)	Two-color Alternate	Flasher Type	One-color	One-color	One-color	One-color × 2 Split-window Type (Type C)			
Fingersafe Spring-up Terminal	Provided (except for check terminal)	(Note 2)	Provided	Provided			(Note 2)			
Rated Voltage (AC: 50/60Hz)	24V AC/DC ±10%	24V AC/DC ±10%	24V DC ±10%	100/110V AC ±10% 200/220V AC ±10%	110V DC (90 to 140V DC)	100/110V AC/DC ±10%	6V AC/DC ±10%	12V AC/DC ±10%	24V AC/DC ±10%	
Maximum Current Draw (VA)	Same as internal LED unit			—	4.7	1.8	2.4	Same as internal LED lamp		
Illumination Color	Amber, blue, green, pure white, red, white, yellow		Red/green Alternate	Amber, blue, green, pure white, red, white, yellow			Amber, blue, green, pure white, red, white, yellow			
Standards	UL, c-UL listed, EN compliant						—			
Built-in LED Unit/Lamp	Rated Voltage	24V AC/DC	24V AC/DC	24V AC/DC			6V AC/DC	12V AC/DC	24V AC/DC	
	Rated Current (Note 7)	Amber	15 mA (Note 5)	Red: 15 mA Green: 15 mA	15 mA			7 mA	10 mA	10 mA
		Blue, Pure White						5.5 mA		
		Green						—		
		Red						7 mA		
		White						7 mA		
Yellow	5.5 mA									
Illumination Color (code)	Amber (A), blue (S), green (G), pure white (PW), red (R), white (W), yellow (Y)		Red (R)/green (G)	Amber (A), blue (S), green (G), pure white (PW), red (R), white (W), yellow (Y)			Amber (A), blue (S), green (G), pure white (PW) (Note 6), red (R), white (W), Y (yellow)			
LED Life (reference)	Approx. 50,000 hours (when used on complete DC, luminance reduces to 50% of the initial intensity)									
Base	Plug-in unit type (for SLC40 only)						BA9S/13 base			
Part No.	SLCN-42M-*		SLCN-42MW-RG	SLCN-42M-*			LSTD-6*	LSTD-1*	LSTD-2*	
No. of Units	1 LED unit per window of basic Type F						1 LED lamp per window of basic Type F			
Flashing Period (Note 3)	—			0.5 ±0.2s	—			—		
Insulation Resistance	100 MΩ (500V DC megger)									
Dielectric Strength	2000V AC (1 minute) between live and dead parts			2500V AC (1 minute) between live and dead parts			2000V AC (1 minute)	2000V AC (1 minute) between live and dead parts		
Operating Temperature (Note 4)	-20 to +40°C		-10 to +40°C	-20 to +40°C	-10 to +40°C	-20 to +40°C	-20 to +40°C			
Storage Temperature	-25 to +60°C (no freezing)									
Operating Humidity	45 to 85% RH (no condensation)									

Specify a color code in place of *.

Note 1: The rated voltage for w/check terminal is 24V DC only.

Note 2: Terminal cover is available (see page 26).

Note 3: Duty 1:1. Multiple flasher units do not synchronize with each other.

Use Type F only.

Note 4: No freezing

Note 5: Spot illumination uses the spot illumination LED unit (SLCN-42ST-*). See page 29 for rated current.

Note 6: Yellow (Y) uses pure white LED lamp.

Note 7: Rated current for LED lamp is for DC. See page 29 for AC.

Incandescent Illuminated

Input		Full Voltage								Transformer	Resistor
Illumination	One-color One-color w/Check Terminal (Note 1)	One-color				Dual-lamp				One-color	
Rated Voltage (AC: 50/60Hz)	6V AC/DC	12V AC/DC	18V AC/DC	24V AC/DC	6V AC/DC	12V AC/DC	18V AC/DC	24V AC/DC	100/110, 200/220V AC	100/110V AC/DC	
Standards	—										
Built-in Lamp	Rated Voltage	6.3V-2W	18V-2W	24V-2W	30V-2W	6.3V-1W	18V-1W	24V-1W	30V-1W	18V-2W	
	Operating Voltage	5 to 6V	12 to 18V	18 to 24V	24 to 30V	5 to 6V	12 to 18V	18 to 24V	24 to 30V	12 to 18V	
Base	E12/15				BA9S/13				E12/15		
Lamp life	Approx. 1,000 hours minimum (mean value when used on the rated voltage)										
Part No.	LE-6	LE-8	LE-2	LE-3	LS-6	LS-8	LS-2	LS-3	LE-8		
No. of Units	1 lamp per window of basic Type F				2 lamps per window of basic Type F				1 lamp per window of basic Type F		
Insulation Voltage	100 MΩ (500V DC megger) between live and dead parts										
Dielectric Strength	2000V AC (1 minute) between live and dead parts								2500V AC (1 minute) between live and dead parts	2000V AC (1 minute) between live and dead parts	
Operating Temperature	-20 to +40°C (no freezing)										
Storage Temperature	-25 to +60°C (no freezing)										
Operating Humidity	45 to 85% RH (no condensation) between live and dead parts										

Note 1: Check terminal is for DC input only.

* Terminal cover is available for all incandescent illuminated (see page 26), except for the resistor type.

LED/Incandescent Illuminated

Illumination Face		Type F (Note 1) (Basic)	Type C (Split-window)	Type H	Type L	Type V	Type G
Illumination Unit Size (mm)	Window (H × W)	40 × 40	20 × 40	40 × 80	40 × 120	80 × 40	80 × 80
	Illumination Face (H × W)	37 × 37	17 × 37	37 × 77	37 × 117	77 × 37	77 × 77
	White color screen, clear marking plate, color screen (H × W × t)	35.8 × 35.8 × 1.0	15.8 × 35.8 × 1.0	35.8 × 75.8 × 1.0	35.8 × 115.8 × 1.0	75.8 × 35.8 × 1.0	75.8 × 75.8 × 1.0
	Marking Film	Applicable	—	—	—	—	—
Engraving Area (white, transparent, color plates)	34 × 34	14 × 34	34 × 74	34 × 114	74 × 34	74 × 74	
Material of Marking Plate & Color Screen	Acrylic						
Lens Frame Color & Frame Cover Color	Black (Munsell N1.5 equivalent)						
Connection Wire	Solid wire: ø1.6 × 2, Stranded 2 mm ² × 2						
Terminal Screw	M3.5 screw, Incandescent resistor: M4 nut Check terminal: M3						
Degree of Protection	IP40 (IEC60529)						
Pollution Degree	3						

Note 1: Flasher, one-window, pure white illumination, and spot illumination are available in Type F only.

SLC40 Series Combination Display Lights

Dimensions

[Front View] a: No. of Rows b: No. of Columns

Type F

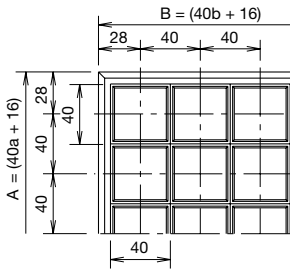

Type F (Spot Illumination)

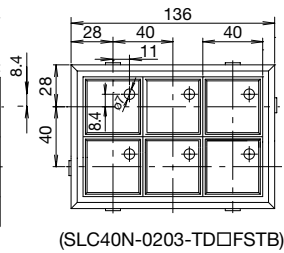

Type H

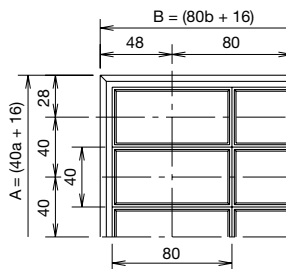

Type V

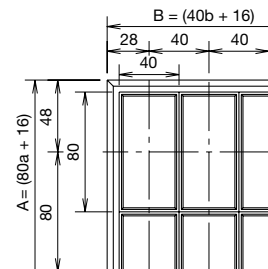

Type L

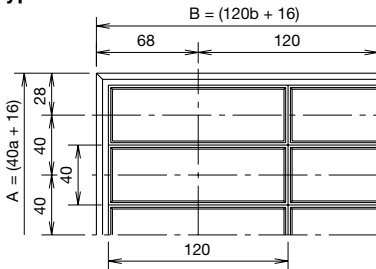

Type G

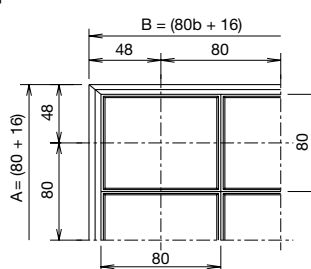

Type C

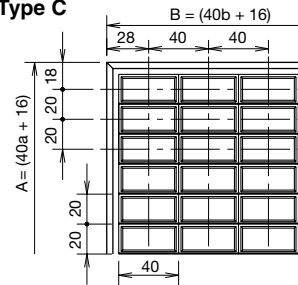

All dimensions in mm.

Type F Dimensions & No. of Windows (Type C, H, L, V, and G can be converted into Type F.)

	Columns	b	01	02	03	04	05	06	07	08	09	10	11	12	13	14	15	16	17	18	19	20	21	22	23	24
Rows	Dimensions	B	56	96	136	176	216	256	296	336	376	416	456	496	536	576	616	656	696	736	776	816	856	896	936	976
a	A	Panel Cut-out (D) (C)	(45)	(85)	(125)	(165)	(205)	(245)	(285)	(325)	(365)	(405)	(445)	(485)	(525)	(565)	(605)	(645)	(685)	(725)	(765)	(805)	(845)	(885)	(925)	(965)
01	56	(45)	1	2	3	4	5	6	7	8	9	10	11	12	13	14	15	16	17	18	19	20	21	22	23	24
02	96	(85)	2	4	6	8	10	12	14	16	18	20	22	24	26	28	30	32	34	36	38	40	42	44	46	48
03	136	(125)	3	6	9	12	15	18	21	24	27	30	33	36	39	42	45	48	51	54	57	60	63	66	69	72
04	176	(165)	4	8	12	16	20	24	28	32	36	40	44	48	52	56	60	64	68	72	76	80	84	88	92	96
05	216	(205)	5	10	15	20	25	30	35	40	45	50	55	60	65	70	75	80	85	90	95	100	105	110	115	120
06	256	(245)	6	12	18	24	30	36	42	48	54	60	66	72	78	84	90	96	102	108	114	120	—	—	—	—
07	296	(285)	7	14	21	28	35	42	49	56	63	70	77	84	91	98	105	112	119	126	—	—	—	—	—	—

How to Read the Table

- The number of windows equals rows multiplied by columns. For example, for 5 rows by 7 columns, the number of windows is 35, external dimensions are 216mm high by 296mm wide, and panel cut-out is 205mm high by 285mm wide.
- External dimensions are represented by A for rows and B for columns in boldface.
- Panel cut-out dimensions are shown in (), for height (C) and width (D). Panel cut-out tolerance is +1.0 to -0 mm (for one window: +0.6 to -0.4mm).

Panel Cut-out (SLC40)

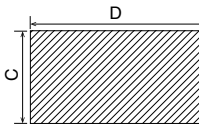

Determine the panel thickness in consideration of the weight of display lights and wires (see page 26).

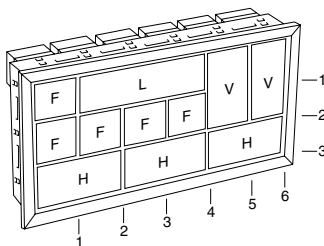

4. Total number of windows, dimensions, panel cut-out

- For Type C, H, L, V, and G, convert the numbers of rows and columns into Type F (basic size) equivalents.

- Type C — Type F equivalent: 2 split-windows consist of one window.



- Type H — Type F equivalent: 2 windows



Height: 1 row
Width: 2 columns

- Type V — Type F equivalent: 2 windows.



Height: 2 rows
Width: 1 column

- Type L — Type F equivalent: 3 windows



Height: 1 row
Width: 3 columns

- Type G — Type F equivalent: 4 windows



Height: 2 rows
Width: 2 columns

- The combination example at left consists of 3 rows by 6 columns.

- The above table shows: No. of windows: 18
Dimensions: 136H x 256W mm
Panel cut-out: 125H x 245W mm

SLC40 Series Combination Display Lights

Dimensions

LED Illuminated [Side & Rear Views]

- Full Voltage
- 24V AC/DC
- One-color full
- For applicable terminal cover, see page 26.
- Spot illumination 24V AC/DC

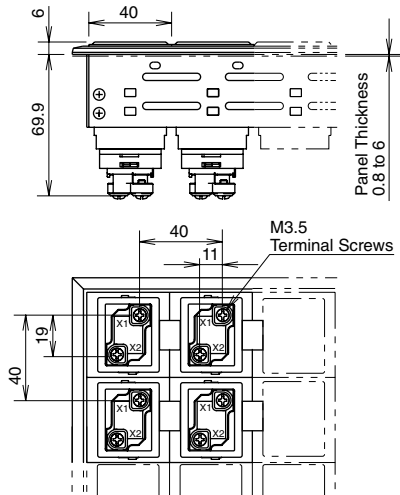

- Full Voltage
- One-color full
- w/Check Terminal 24V DC
- Two-color alternate 24V AC/DC
- For applicable terminal cover, see page 26.

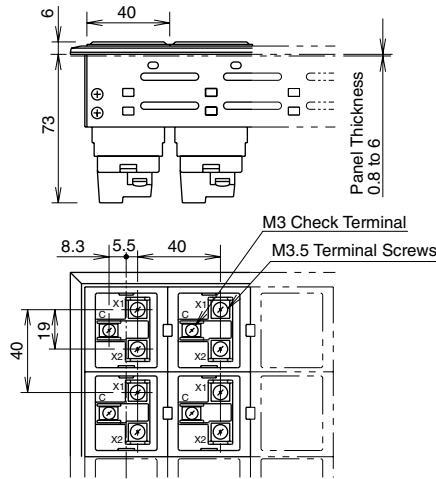

- Full Voltage
- One-color full
- Flasher 24V DC (Type F only)
- For applicable terminal cover, see page 26.

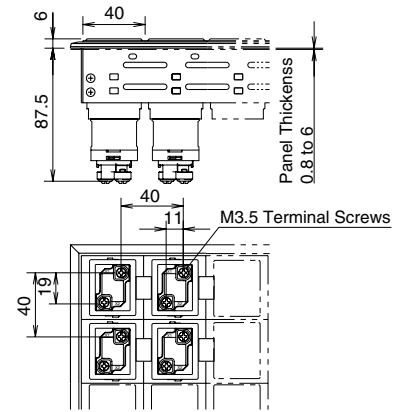

- w/Check Terminal
Terminal X1 is a positive pole; Terminal X2 and C (check terminal) are negative poles.
- Two-color Alternate
Terminal X1 is common.
Red (R) illumination: Terminal C
Green (G) illumination: Terminal X2

- Terminals X1 and X2 are positive and negative poles, respectively.

- Transformer
- One-color full
- 100/110, 200/220V AC
- 110VDC (DC-DC Converter)

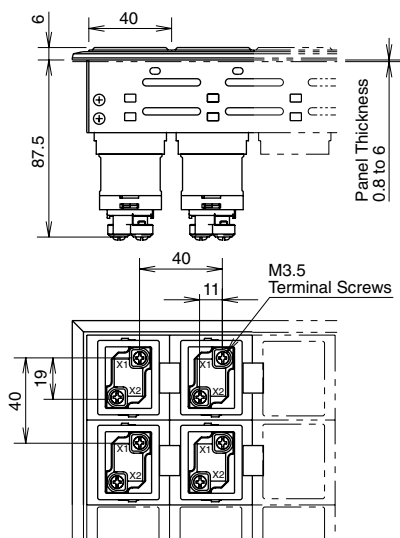

- Resistor
- One-color full
- 100/110V AC/DC

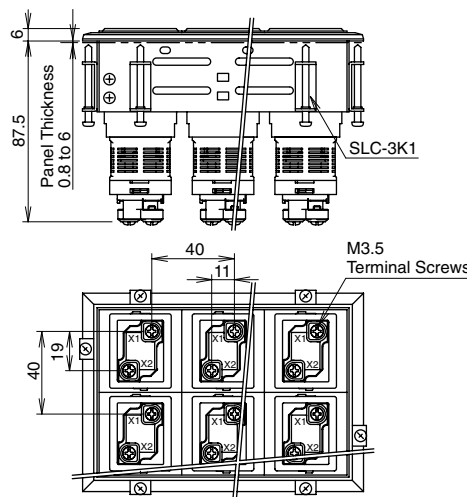

Type C (split-window)

- Full Voltage
- 6, 12, 24V AC/DC
- One-color full, 2 x LED lamps, Split-window

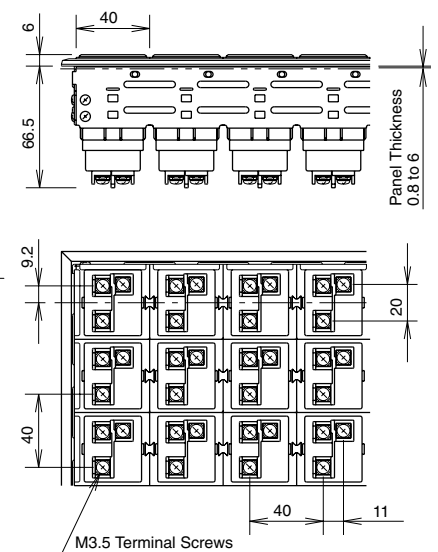

- On LED illuminated DC-DC Converter type units, Terminals X1 and X2 are positive and negative poles, respectively.

- Terminal X1 is COM terminal.
- For applicable terminal cover, see page 26.

All dimensions in mm.

SLC40 series Combination Display Lights

Incandescent Illuminated [Side & Rear Views]

Type F

- Full Voltage
- 6, 12, 18, 24V AC/DC
- One-color full
- For applicable terminal cover, see page 26.

- Full Voltage
- One-color full
- w/Check Terminal
- 6, 12, 24V DC
- For applicable terminal cover, see page 26.

- Full Voltage
- 6, 12, 18, 24V AC/DC
- One-color full
- For applicable terminal cover, see page 26.

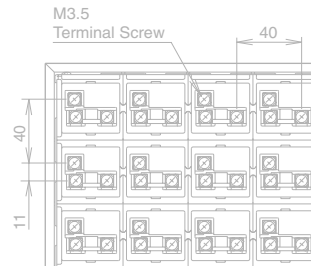
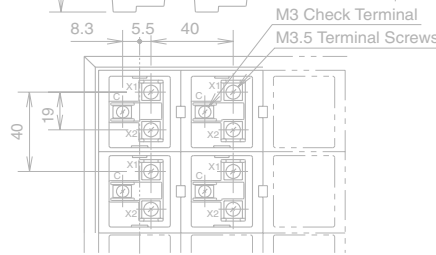
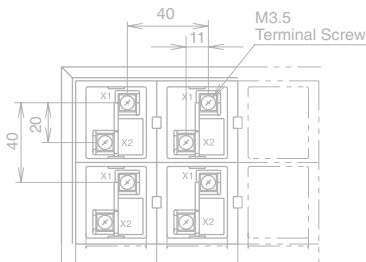
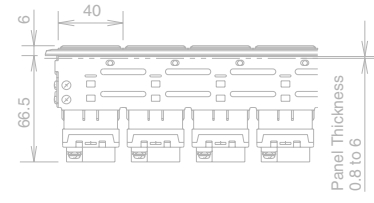
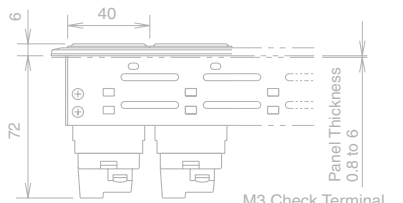
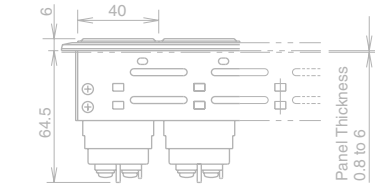

- The dimension of incandescent illuminated 100/110, 200/220V AC is the same as LED illuminated flasher.

- Incandescent illuminated w/check terminal Terminal X1 and C are positive poles; Terminal X2 is a negative pole.

- Transformer
- 100/110, 200/220V AC
- One-color full

- Resistor
- 100/110V AC/DC
- One-color full

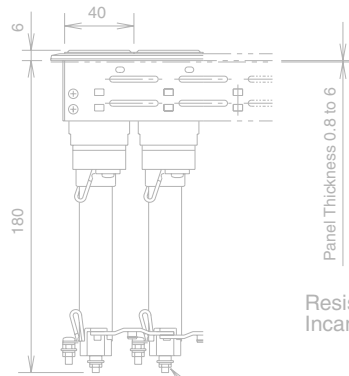
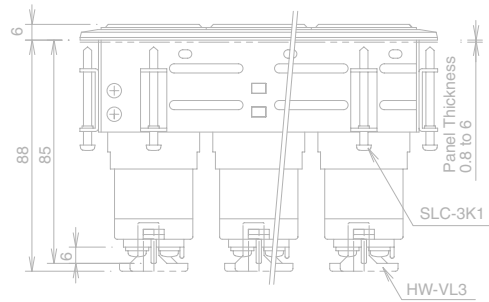

Resistance Incandescent: 1kΩ, 40W

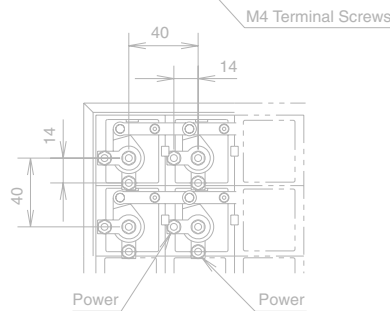
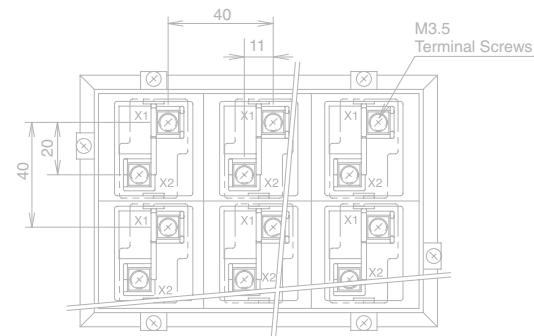

All dimensions in mm.

SLC40 series Combination Display Lights

Dimensions

LED Illuminated [One-window, Type F only]

Full Voltage 24V AC/DC, One-color Full

Spot Illumination

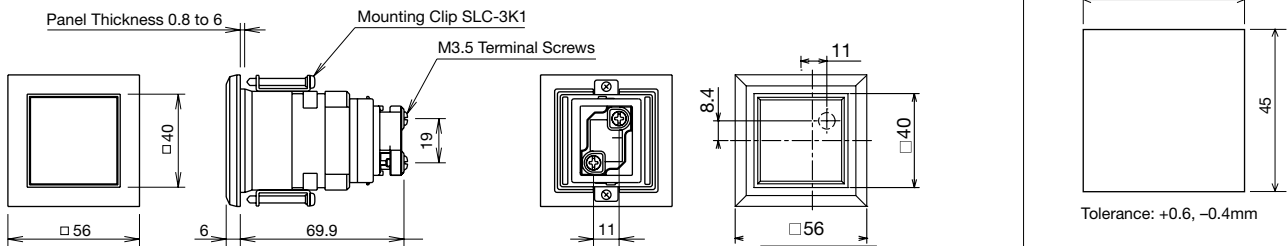

Full Voltage 24V DC, w/Check Terminal

Two-color Alternate LED Illuminated 24V AC/DC

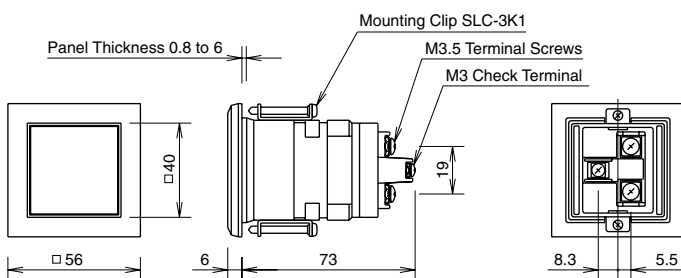

- w/Check Terminal
Terminal X1 is a positive pole; Terminals X2 and C (check terminal) are negative poles.
- Two-color Alternate
Red (R) illumination: X1, C
Green (G) illumination: X1, X2
- See page 26 for applicable terminal covers.

Flasher 24V DC

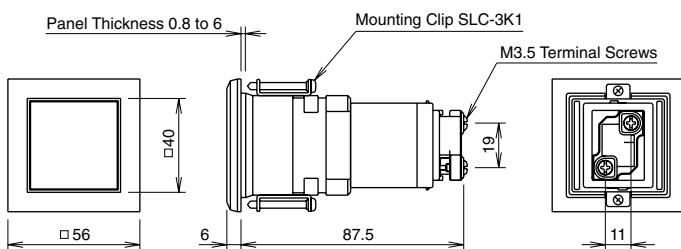

- On LED illuminated flasher, Terminals X1 and X2 are positive and negative poles, respectively.
- See page 26 for applicable terminal covers.

Transformer 100/110, 200/220V AC

DC-DC Converter 110V DC

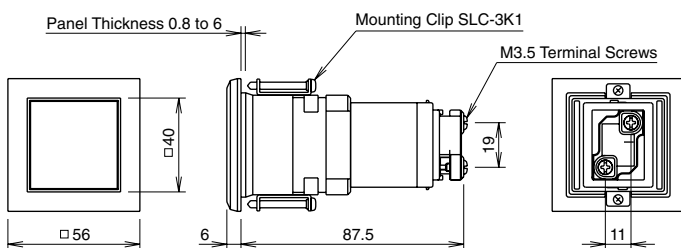

- On LED illuminated DC-DC converter type, Terminals X1 and X2 are positive and negative poles, respectively.

Resistor 100/110V AC/DC

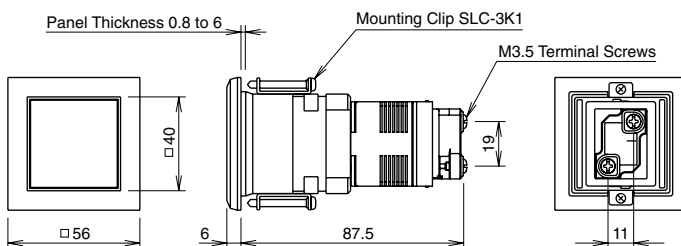

(Resistance)
LED illuminated: 4.4 kΩ, 6W

All dimensions in mm.

SLC40 series Combination Display Lights

Incandescent Illuminated [One-window, Type F only]

Full Voltage 6, 12, 18, 24V AC/DC, One-color Full

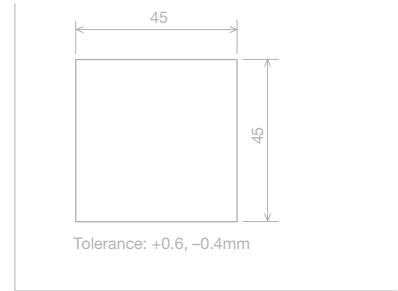
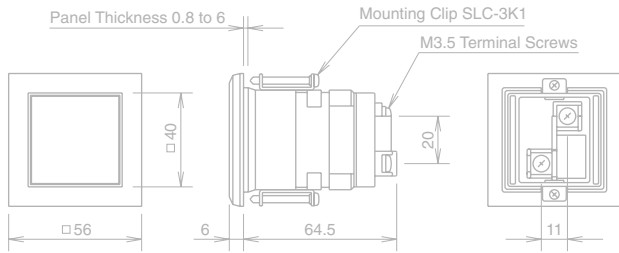

Full Voltage 24V DC, w/Check Terminal, One-color Full

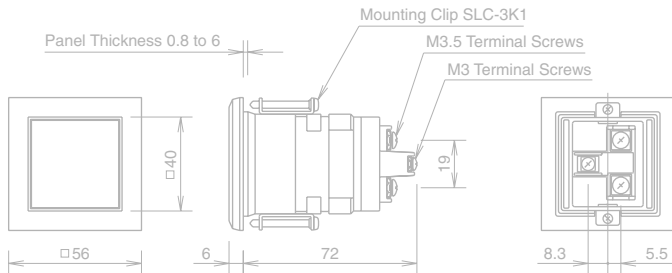

- w/Check Terminal
Terminal X1 is a positive pole; Terminal X2 and C (check terminal) are negative poles.
- For applicable terminal cover, see page 26.

Transformer 100/110, 200/220V AC, One-color Full

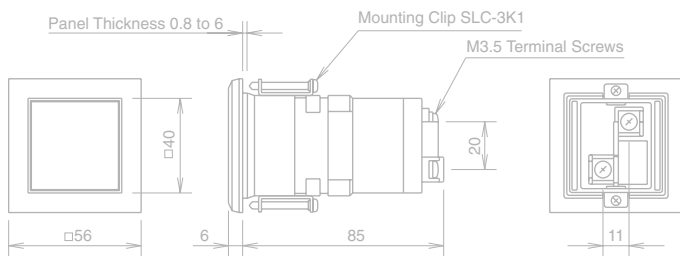

- For applicable terminal cover, see page 26.

Resistor 100/110V AC/DC, One-color Full

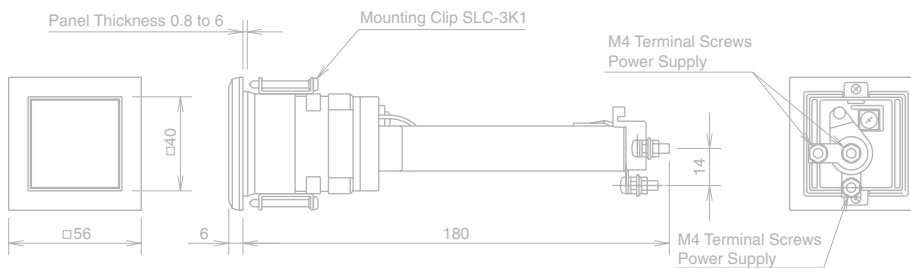

(Resistance)
Incandescent: 1 kΩ, 40W

Full Voltage 6, 12, 18, 24V AC/DC, One-color Full (Dual-lamp)

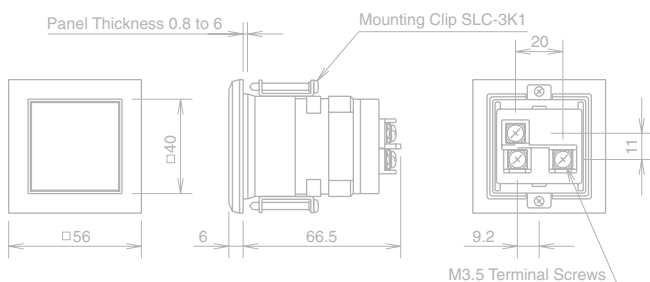

- On dual-lamp, Terminal X1 is a common terminal. Terminals X1 and X2 are interconnected.
- For applicable terminal cover, see page 26.

All dimensions in mm.

SLC40 Series Combination Display Lights

Terminal Connection (LED Illuminated)

- For check terminal, DC-DC converter, and resistor, Terminals X1 and X2 are positive and negative poles, respectively.

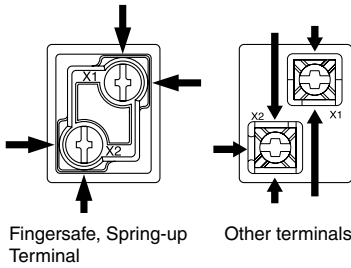

Arrows indicate access direction for wiring terminals.

(Flasher Connection Diagram)

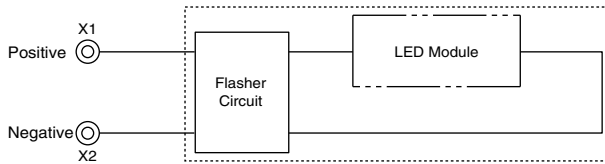

- For w/check terminal and two-color alternate units, Terminal X1 is a positive pole; Terminals X2 and C (check terminal) are negative poles. For two-color alternate, Terminal X1 is common.

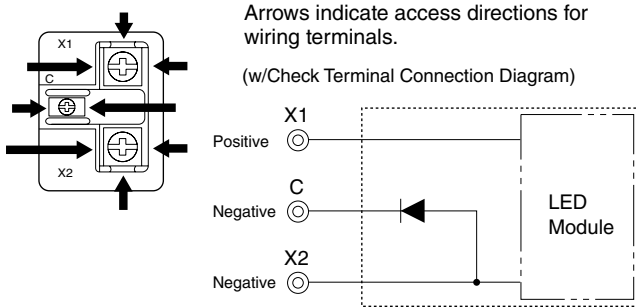

- Connection for Two-color alternate is as follows. Terminal X1 (+) is common (AC/DC). Red (R): Terminal C, Green (G): Terminal X2

(Two-color alternate Connection Diagram)

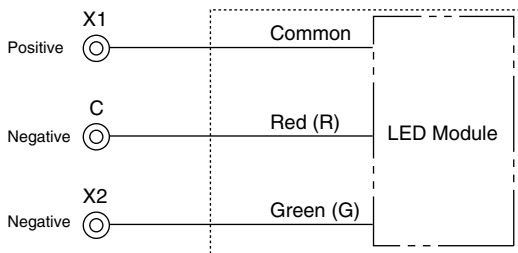

- For the LED illuminated split-window (Type C), Terminal X1 (+) is a common terminal. Terminal X2 is for upper illumination and Terminal X3 is for lower illumination (AC/DC).

Arrows indicate access direction for wiring terminals.

(Type C Split-window Connection Diagram)

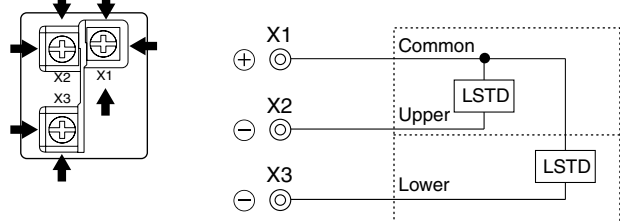

Recommended tightening torque:
M3.5: 1 to 1.3 N·m
M3: 0.6 to 1.0 N·m

Terminal Connection Using Jumpers

- For terminal connection of types F, H, L, V, and G (except Type C) using jumpers, jumpers can be used as shown below.

SLC40 Series

		Terminal X1	Terminal X2	Terminal C
LED Illuminated (Note 2)	Fingersafe, Spring-up Terminal (Note 1)	SLCN-JP44 SLCN-JP45	SLCN-JP44 SLCN-JP45	—
	Others	SLC-JP40	SLC-JP41	SLC-JP42
Incandescent Illuminated		SLC-JP40	SLC-JP41	SLC-JP42

Note 1: Fingersafe, spring-up terminals are used in one-color full illuminated (12, 24V AC/DC, 100/110, 200/220V AC, 110V DC).

Note 2: No jumper is used on resistor type.

- For Type C, jumpers can be used on Terminal X1 only as shown below.

Direction	• When using Type C only • When using Type C and Two-color alternate
Vertical	SLC-JP40
Horizontal	SLC-JP41

Note: Jumpers cannot be used when using Type C and fingersafe spring-up terminals.

Terminal Connection (Incandescent Illuminated)

- For incandescent illuminated dual-lamp, terminal X1 is a common terminal. Terminals X2 and X3 are connected with jumpers.
- The incandescent illuminated check terminal is for DC voltage only. Terminal X1 is a positive pole, and terminal X2 is a negative pole. Check terminal is a positive pole.
- Wiring direction for incandescent illuminated check terminals is the same as that of LED illuminated type.

[Examples of Using Jumpers]

LED Illuminated (fingersafe Spring-up Terminal)

When using two windows

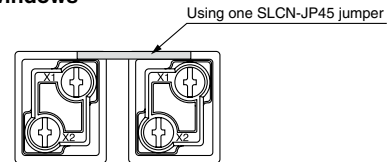

When using three windows

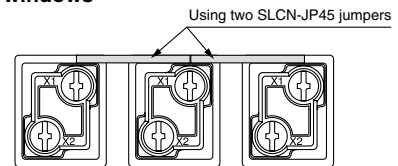

When using four windows

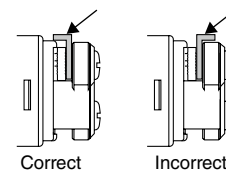
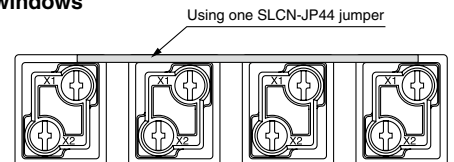

Jumpers (SLCN-JP44/45) have an orientation. Ensure that jumpers are installed correctly.

SLC40 Series Combination Display Lights

Part No. Development

SLC40N - 0405 - TD2FB - Example: G (5), R (5), W (10)
Specify the color code and the number of windows.

40 Series

When ordering Type H, L, V, G, or C units, enter the equivalents of Type F.

Frame Color
Black: B

Equivalent of Basic Size Windows	
Rows	Columns
01	01
02	02
03	03
04	04
05	05
06	06
07	07
08	
09	
10	
11	
12	
13	
14	
15	
16	
17	
18	
19	
20	
21	
22	
23	
24	

Unit		(Code)	Operating Voltage (Built-in Lamp)		(Code)	
LED Illuminated	LED Unit	Full Voltage (A, G, R, W, Y)	DD	12V AC/DC ±10%	1	
				24V AC/DC ±10%	2	
		Full Voltage (PW, S)	DDA	24V AC/DC ±10%	2	
		Full Voltage w/Check Terminal (A, G, R, W, Y)	DHM	24V DC ±10%	2	
		Full Voltage Two-color Alternate (R/G)	DW	24V AC/DC ±10%	2	
		Full Voltage Flasher (A, G, R, W, Y)	DF	24V DC ±10%	2	
		Transformer (A, G, R, W, Y)	TD	100/110V AC ±10%	1	
				200/220V AC ±10%	2	
		Transformer (PW, S)	TDA	100/110V AC ±10%	1	
				200/220V AC ±10%	2	
		DC-DC Converter (A, G, R, W, Y)	CD	110V DC (90 to 140V DC)	1	
Resistor (A, G, R, W, Y)	RN	100/110V AC/DC ±10%	1			
Incandescent Illuminated	LED Lamp	One-color Full × 2 split window (Type C) (A, G, R, W, Y)	BA9S/13 Base	DP	6V AC/DC ±10% (LSTD-6*)	6
					12V AC/DC ±10% (LSTD-1*)	1
					24V AC/DC ±10% (LSTD-2*)	2
		Full Voltage	E12/15 Base	DE	5 to 6V AC/DC (LE-6)	6
					12 to 18V AC/DC (LE-8)	8
					18 to 24V AC/DC (LE-2) (Note)	2
		Transformer	E12/15 Base	TE	24 to 30V AC/DC (LE-3)	3
					100/110V AC ±10% (LE-8)	1
					200/220V AC ±10% (LE-8)	2
		Resistor	E12/15 Base	RE	100/110V AC/DC ±10% (LE-8)	1
					5 to 6V AC/DC (LS-6)	6
12 to 18V AC/DC (LS-8)	8					
Full Voltage Dual Lamp	BA9S/13 Base	DB	18 to 24V AC/DC (LS-2) (Note)	2		
			24 to 30V AC/DC (LS-3)	3		
			5 to 6V DC (LE-6)	6		
Full Voltage w/Check Terminal	E12/15 Base	DEM	12 to 18V DC (LE-8)	8		
			24 to 30V DC (LE-3)	3		

Illumination Face Size		(Code)
• Type F	40 × 40 mm	F
• Type H	40 × 80 mm	H
• Type L	40 × 120 mm	L
• Type V	80 × 40 mm	V
• Type V	80 × 80 mm	G
• Type C	(20 × 40 mm) × 2	C
• Type F Spot Illumination	40 × 40mm	FST

Illumination Color	
Clear Lens Combination	(Code)
Amber	A
Green	G
Pure White	PW
Red	R
Blue	S
White	W
Yellow	Y
Red/Green	RG

Color Screen Combination		(Code)
* (LED only)		
When color display is required at power off, order color screens. For details, see page 34.		
Amber	TA	
Green	TG	
Pure White	TPW	
Red	TR	
Blue	TS	
White	TW	
Yellow	TY	

Gray Lens Combination		(Code)
Amber	SA	
Green	SG	
Pure White	SPW	
Red	SR	
Blue	SS	
White	SW	
Yellow	SY	

* Type H, L, V, and G cannot be split-illuminated.
* Enter the required number of color screens in ().

The following color/voltage selections are also available.

Unit		(Code)	Operating Voltage (Built-in Lamp)		(Code)	
LED Illuminated	LED Unit	Full Voltage w/Check Terminal (PW, S)	DHMA	24V DC ±10%	2	
		Full Voltage Flasher (PW, S)	DFA	24V AC/DC ±10%	2	
		Transformer (A, G, R, W, Y)	TD	115V AC ±10%	11	
				120V AC ±10%	12	
				230V AC ±10%	23	
				240V AC ±10%	24	
				380V AC ±10%	38	
				400/440V AC ±10%	4	
		Transformer (PW, S)	TDA	480V AC ±10%	48	
				115V AC ±10%	11	
				120V AC ±10%	12	
230V AC ±10%	23					
240V AC ±10%	24					
380V AC ±10%	38					
DC-DC Converter (PW, S)	CDA	110V DC (90 to 140V DC)	1			
Resistor (PW, S)	RNA	100/110V AC/DC ±10%	1			
LED Lamp	BA9S/13 Base	One-color Full window (Type C) (combination of PW, S only)	DPA	6V AC/DC ±5% (LSTD-6S) × 2	6	
				12V AC/DC ±10% (LSTD-1S) × 2	1	
		One-color Full window (Type C) (combination of PW)	DPC	24V AC/DC ±10% (LSTD-2S) × 2	2	
				6V AC/DC ±5% (LSTD-6*)	6	
Incandescent Illuminated	LED Lamp	S and A, G, R, W, Y)	E12/15 Base	TE	12V AC/DC ±10% (LSTD-1*)	1
					24V AC/DC ±10% (LSTD-2*)	2
					115V AC ±10% (LE-8)	11
					120V AC ±10% (LE-8)	12
					230V AC ±10% (LE-8)	23
					240V AC ±10% (LE-8)	24
					380V AC ±10% (LE-8)	38
					400/440V AC ±10% (LE-8)	4
					480V AC ±10% (LE-8)	48

Note: For longer lamp life, LE-3 (30V rating, 2W lamp) or LS-3 (30V rating, 1W) lamps are recommended when using on 24V AC/DC.

SLC40 Series Combination Display Lights

Ordering Information

When ordering SLC Series Combination Display Lights, use the specification sheet provided on page 39.

Designation Procedure

1. Part No.: Refer to Part No. Development on page 24.
2. Quantity: Enter the required number of identical assemblies.

Counting of Windows

Count the number of windows in the equivalent of Type F (basic size).

Leaf Springs

Leaf spring for temporary fastening is not attached, and can be supplied free of charge upon request when ordering (Part No. SLD40KVP).

[Conversion Rate]

- Type H (horizontal)
 - Type F equivalent: 2 windows
Row (1), Column (2)
- Type L (horizontal)
 - Type F equivalent: 3 windows
Row (1), Column (3)
- Type V (vertical)
 - Type F equivalent: 2 windows
Row (2), Column (1)
- Type G (large)
 - Type F equivalent: 4 windows
Row (2), Column (2)
- Type C (split-window)
 - Type F equivalent: 1 window
Row (1), Column (1)

[Designation Examples]

Ex. 1 SLC40 Series
Type F, 20 windows

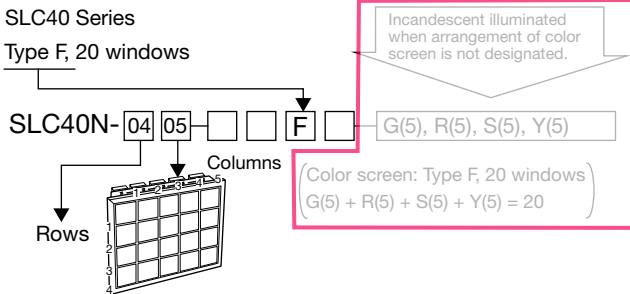

Ex. 2 SLC40 Series
Type H, 9 windows (Type F equivalent: 3 rows by 6 columns)

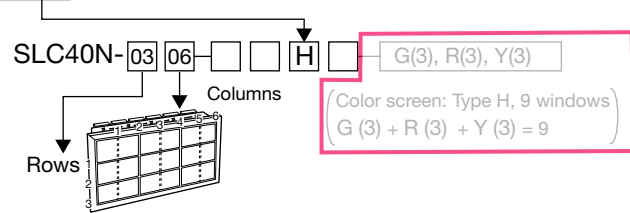

Ex. 3 SLC40 Series (Type F, 12 windows)
When ordering a combination of units with different operating voltages, specify Part No. as follows.

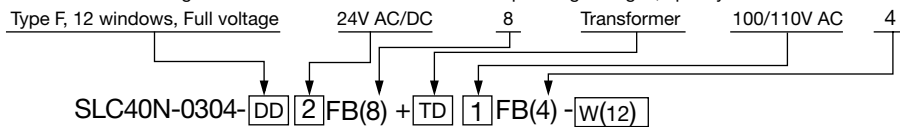

Specify the position of the units and each voltage on the specification sheet.

Ex. 4 When ordering a combination of units with different illumination colors, specify Part No. as follows.

Example: Full voltage LED illuminated 24V AC/DC, Red (6), Pure White (2)

SLC40N-0204-DD2FB(6) + DDA2FB(2) - R(6)PW(2)
Red Pure White Designation
Red: 6, Pure White: 2

Specify the position of the units and each color code on the specification sheet.

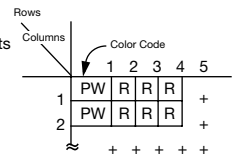

Ex. 5 When ordering a combination of units with different illumination colors for four windows of type C, specify Part No. as follows.

Example: Full voltage LED illuminated 24V AC/DC

SLC40N-0202-DPA2CB(1) DPC2CB(3) - R(1)G(1)A(1)S(1)PW(4)
Blue, Pure white Red, green, Designation
amber, pure white Red: 1, green: 1, blue 1, amber 1, pure white 4

Specify the position of the units and each color code on the specification sheet.

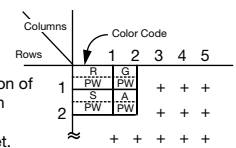

LED illuminated units in one color.

R (20)
(Color screen: Type F, 20 windows)
R (20) = 20

- When color screen is required, specify the color screen code.

Ex. T * Color Code
Color Screen Code

• When more than one color is required for LED.
• When a particular arrangement of color screen is required.

No entry is required in designations.

Specify each color code on the specification sheet.

Columns	Color Code	1	2	3	4	5	6
Rows	1	R	R	G	G	G	+
	2	Y	Y	Y	Y	Y	+
	3	A	A	W	W	W	+
	4	A	A	W	W	W	+
	5	+	+	+	+	+	+

• When color screen is required, specify the color screen code.

Ex. T * Color Code
Color Screen Code

G (9)
(Color screen: Type H, 9 windows)
G (9) = 9

No entry is required in designations.

Specify each color code on the specification sheet.

Columns	Color Code	1	2	3	4	5	6	7
Rows	1	W	R	R				+
	2	W	R	R				+
	3	W	G	G				+
	4	+	+	+	+	+	+	+

• When color screen is required, specify the color screen code.

Ex. T * Color Code
Color Screen Code

Columns	Color Code	1	2	3	4	5
Rows	1					DD2
	2					TD1
	3	+	+	+	+	+
	4	+	+	+	+	+

SLC30/40 series Combination Display Lights Accessories

Terminal Cover

Ordering Terminal Covers

- The fingersafe, spring-up terminal types have integral covers, and do not require terminal covers.
- Terminals other than fingersafe, spring-up terminals do not have terminal covers and need covers ordered separately.
- Incandescent illuminated resistor type cannot use terminal covers.

Applicable Terminal Covers (Material: PPE)

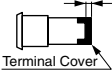
Series	Style	Applicable Terminal Covers						When using a terminal cover, the depth is extended shown as below. 
		SLC30-VL3 29H x 28W	HW-VL3 38H x 26W	SLC30-VL5 29H x 28W	SLC40-VL5 36H x 33.5W	SLC30-VL6 29H x 26W	SLC40-VL6 39H x 28W	
SLC30	LED Illuminated	LED One-color Full w/Check Terminal					Applicable	+5.7 mm
		Two-color Alternate					Applicable	+5.7 mm
		Type C (half-type) one color Full x 2			Applicable			+2.5 mm
	Incandescent Illuminated	One-color Full	Applicable					+4.5 mm
SLC40	LED Illuminated	LED One-color Full w/Check Terminal					Applicable	+4.7 mm
		Two-color Alternate					Applicable	+4.7 mm
		Type C (half-type) one color Full x 2				Applicable		+3 mm
	Incandescent Illuminated	One-color Full		Applicable				+3 mm
		One-color Full w/Check Terminal					Applicable	+4.7 mm
		One-color Full Dual-lamp				Applicable		+3 mm

Weight

Approximate weight of SLC combination display lights can be calculated in the formula below.

$$\text{Weight} = \underbrace{A \times (\text{No. of Rows} + \text{No. of Columns})}_{\text{Frame Weight Type F equivalent}} + \underbrace{B \times \text{No. of Windows}}_{\text{Display Weight Type F equivalent}}$$

Series	A	B (including light source)					
		(Full Voltage) 6V AC/DC 12V AC/DC 24V AC/DC	(Full Voltage) Flasher	(Transformer) 100/110V AC 200/220V AC	(Resistor) 100/110V DC 100/110V AC/DC (Note 2)	(DC-DC Converter) 110V DC	Type C Split-window (Type F equivalent)
SLC30 (Approx.)	22g	38g	48g	Incandescent: 105g LED: 85g	Incandescent: 72g LED: 47g	54g	46g
SLC40 (Approx.)	30g	60g	71g	126g	Incandescent: 125g LED: 69g	77g	66g



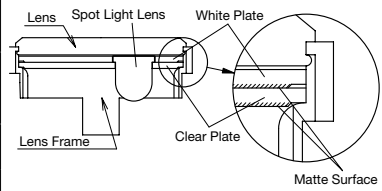

SLC30/40 Series Combination Display Lights Accessories

Accessories / Replacement Parts

Accessories

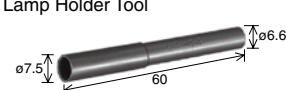
Name & Shape	Applicable Model	Part No.	Ordering No.	Package Quantity	Remarks
Spot Illumination Kit for Type F Window White Plate  Clear Plate (supplied with the spot illumination type SLC)	SLC30N	SLCN-3ST-F2	SLCN-3ST-F2	1	
	SLC40N	SLCN-4ST-F2	SLCN-4ST-F2	1	
White Screen for Spot Illumination	SLC30N	SLDN-3C-FW-ST1	SLDN-3C-FW-ST1	1	
	SLC40N	SLDN-4PF-FW-ST1	SLDN-4PF-FW-ST1	1	

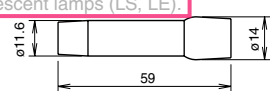
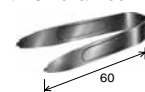
Tool Accessories

Name & Shape	Material	Part No.	Ordering No.	Package Quantity	Remarks
Lamp Holder Tool 	Rubber	OR-44	OR-44	1	Used for replacing LED lamps (LFTD) for SLC30 Type C (Split-window).
Lamp Holder Tool 	Rubber	OR-55	OR-55	1	Used for replacing LED lamps (LSTD) or incandescent lamps (LS, LE). 
LED Unit Removal Tool 	Metal	MT-101	MT-101	1	Used for removing the LED unit for the SLC30/40 series.
Lens Unit Removal Tool 	Rubber (Ring: metal)	MT-S01	MT-S01	1	Used for removing the lens unit.

Marking Plate, Color Screens

Name & Shape	Series	Applicable Window	Dimensions (mm)	Part No.	Ordering No.	Color Code	Package Quantity	
Color Screen (LED/Incandescent) 	SLC30	F	27H x 27W x 1.0t	SLDN-3C-*	SLDN-3C-* PN05	A: Amber C: Clear (clear screen) FW: White (white screen) G: Green R: Red (Type F) RL: Red (Except Type F) S: Blue Y: Yellow	5	
		H and V	27H x 57W x 1.0t	SLC-3PH-*	SLC-3PH-* PN05			
		H (split-window)	27H x 28.5W x 1.0t	SLC-3PH2-*	SLC-3PH2-* PN05			
		L	27H x 87W x 1.0t	SLC-3PL-*	SLC-3PL-* PN05			
		G	57H x 57W x 1.0t	SLC-3PG-*	SLC-3PG-* PN05			
		C (LED only)	12H x 27W x 1.0t	SLC-3PC-*	SLC-3PC-* PN05			
	SLC40	F	35.8H x 35.8W x 1.0t	Acrylic	SLCN-4PF-*			SLCN-4PF-* PN05
		H and V	75.8H x 35.8W x 1.0t		SLC-4PH-*			SLC-4PH-* PN05
		L	35.8H x 115.8W x 1.0t		SLC-4PL-*			SLC-4PL-* PN05
		G	75.8H x 75.8W x 1.0t		SLC-4PG-*			SLC-4PG-* PN05
		C (LED only)	15.8H x 35.8W x 1.0t		SLC-4PC-*			SLC-4PC-* PN05
		F	27H x 27W x 1.0t		SLDN-3C-FW			SLDN-3C-FW
		H and V	27H x 57W x 1.0t		SLC-3PH-FW			SLC-3PH-FW
		H (split-window)	27H x 28.5W x 1.0t		SLC-3PH2-FW			SLC-3PH2-FW
SLC30	L	27H x 87W x 1.0t	SLC-3PL-FW	SLC-3PL-FW				
	G	57H x 57W x 1.0t	SLC-3PG-FW	SLC-3PG-FW				
	C (LED only)	12H x 27W x 1.0t	SLC-3PC-FW	SLC-3PC-FW				
	SLC40	F	35.8H x 35.8W x 1.0t	SLCN-4PF-FW	SLCN-4PF-FW			
		H and V	75.8H x 35.8W x 1.0t	SLC-4PH-FW	SLC-4PH-FW			
		L	35.8H x 115.8W x 1.0t	SLC-4PL-FW	SLC-4PL-FW			
		G	75.8H x 75.8W x 1.0t	SLC-4PG-FW	SLC-4PG-FW			
		C (LED only)	15.8H x 35.8W x 1.0t	SLC-4PC-FW	SLC-4PC-FW			

Note: For insertion order into SLC frames or markings, see operating instructions on page 34 and 35.



SLC30/40 series Combination Display Lights Accessories

Replacement Parts

Lens



Name & Shape	Description	Series	Applicable Window	Dimensions (mm)	Material	Part No.
Lens LED/Incandescent 	Clear	SLC30	F	28H x 28W x 2.8t	Acrylic	SLC-3LF
			H and V	28H x 58W x 2.8t		SLC-3LH
			L	28H x 88W x 2.8t		SLC-3LL
			G	58H x 58W x 2.8t		SLC-3LG
			C LED only	13H x 28W x 2.8t		SLC-3LC
		SLC40	F	36.8H x 36.8W x 2.8t		SLC-4LF
			H and V	36.8H x 76.8W x 2.8t		SLC-4LH
			L	36.8H x 116.8W x 2.8t		SLC-4LL
			G	76.8H x 76.8W x 2.8t		SLC-4LG
			C LED only	16.8H x 36.8W x 2.8t		SLC-4LC
	Gray	SLC30	F	28H x 28W x 2.8t	SLC-3LF-M	
			H and V	28H x 58W x 2.8t	SLC-3LH-M	
			L	28H x 88W x 2.8t	SLC-3LL-M	
			G	58H x 58W x 2.8t	SLC-3LG-M	
			C LED only	13H x 28W x 2.8t	SLC-3LC-M	
		SLC40	F	36.8H x 36.8W x 2.8t	SLC-4LF-M	
			H and V	36.8H x 76.8W x 2.8t	SLC-4LH-M	
			L	36.8H x 116.8W x 2.8t	SLC-4LL-M	
G	76.8H x 76.8W x 2.8t	SLC-4LG-M				
C LED only	16.8H x 36.8W x 2.8t	SLC-4LC-M				

Lens Frame

Shape	Series	Applicable Window	Material	Part No.	
				LED Illuminated	Incandescent Illuminated
For LED  For Incandescent 	SLC30	F	ABS	SLC-3WF-BL	SLC-3WF-B
		H		SLC-3WH-BL	SLC-3WH-B
		H (split-window) (Note)		SLC-3WH2-BL	SLC-3WH2-B
		L	PC	SLC-3WL-BL	SLC-3WL-B
		V	ABS	SLC-3WV-BL	SLC-3WV-B
		G		SLC-3WG-BL	SLC-3WG-B
	C	SLC-3WC-BL		—	
	SLC40	F	PC	SLC-4WF-BL	SLC-4WF-B
		H		SLC-4WH-BL	SLC-4WH-B
		L		SLC-4WL-BL	SLC-4WL-B
		V	ABS	SLC-4WV-BL	SLC-4WV-B
		G		SLC-4WG-BL	SLC-4WG-B
		C		SLC-4WC-BL	—

Note: A light barrier is supplied.

LED Units



Series & Shape	Illumination	Operating Voltage	Rated Current	Part No.	Ordering No.	Color Code
SLC30  Weight: approx. 4.3g	One color full	6V AC/DC	Amber, green, red, yellow:12mA White: 21mA	SLDN-36M-*	SLDN-36M-* T	Specify a color code in place of * in the Part No.
		12V AC/DC	Amber, green, red, white, yellow: 12mA	SLDN-31M-*	SLDN-31M-* T	
		24V AC/DC	Amber, red, white: 12mA Blue, green, pure white, yellow: 11mA	SLDN-32M-*	SLDN-32M-* T	
	Two-color alternate	24V DC	Red: 12mA/green: 11mA	SLDN-32MW-RG	SLDN-32MW-RGT	A (amber) G (green) PW (pure white) R (red) S (blue) W (white) Y (yellow)
SLC40  Weight: approx. 9.2g	One color full	24V AC/DC	Amber, blue, green, pure white, red, yellow, white: 15mA	SLCN-42M-*	SLCN-42M-* T	
	Two-color alternate	24V AC/DC	Red: 15mA/green: 15mA	SLCN-42MW-RG	SLCN-42MW-RGT	

Note: Blue (S) and PW (pure white) are 24V AC/DC only

SLC30/40 Series Combination Display Lights Accessories



Replacement Parts

LED Units for Spot Illumination

Series & Shape	Rated Voltage (AC: 50/60 Hz)	Rated Current	Part No.	Ordering No.	Color Code
SLC30  Weight: approx. 4.5g	24V AC/DC	Amber, red, white: 12mA Blue, green, pure white, yellow: 11mA	SLDN-32ST-*	SLDN-32ST-* T	Specify a color code in place of * in the Part No. A (amber) G (green) PW (pure white) R (red) S (blue) W (white) Y (yellow)
SLC40  Weight: approx. 9.4g	24V AC/DC	Amber, blue, green, pure white, red, white, yellow: 15mA	SLCN-42ST-*	SLCN-42ST-* T	

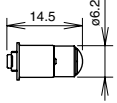

• Used with SLCN-ST-* spot illumination kit. The spot color is same as illumination surface.

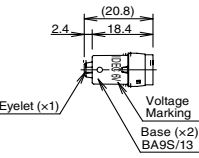
LED Lamps

Shape	Operating Voltage	Current Draw		Part No.	Ordering No.	Illumination Color	Package Quantity	Base
		DC Rating	AC Rating					
LFTD Lamp (SLC30)  	5V DC	8 mA	—	LFTD-5*	LFTD-5*	Specify a color code in place of * in the Part No. A (amber) G (green) PW (pure white) R (red) S (blue) W (white)	1	SX6S/8 × 5.4
							LFTD-5*PN10	
	6V AC/DC	7 mA	9 mA (A, R, W, Y) 10 mA (G, S, PW)	LFTD-6*	LFTD-6*		1	
							LFTD-6*PN10	
	12V AC/DC	8 mA	9 mA	LFTD-1*	LFTD-1*		1	
							LFTD-1*PN10	
24V AC/DC	8 mA	9 mA	LFTD-2*	LFTD-2*	1			
					LFTD-2*PN10	10		
LSTD Lamp (SLC40)  	6V AC/DC	7 mA (A, R, W) 5.5 mA (G, S, PW)	8 mA (A, G, PW, R, S, W)	LSTD-6*	LSTD-6*	A (amber) G (green) PW (pure white) (Note) R (red) S (blue) W (white)	1	BA9S/13
							LSTD-6*PN10	
	12V AC/DC	10 mA	11 mA	LSTD-1*	LSTD-1*		1	
							LSTD-1*PN10	
	24V AC/DC	10 mA	11 mA	LSTD-2*	LSTD-2*		1	
							LSTD-2*PN10	

Note: For Type C and Yellow (Y) illumination, use yellow (Y) color screen and pure white (PW) LED lamp.

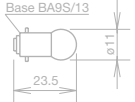
Incandescent Lamps

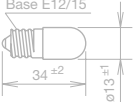



Shape	Operating Voltage	Ratings	Part No.	Base
LS Lamp  	6V AC/DC	1W (6.3V)	LS-6	BA9S/13
	12V AC/DC	1W (18V)	LS-8	
	18V AC/DC	1W (24V)	LS-2	
	24V AC/DC	1W (30V)	LS-3	
LE Lamp  	6V AC/DC	2W (6.3V)	LE-6	E12/15
	12V AC/DC	2W (18V)	LE-8	
	18V AC/DC	2W (24V)	LE-2	
	24V AC/DC	2W (30V)	LE-3	

All dimensions in mm.





SLC30/40 series Combination Display Lights Accessories

Accessories / Replacement Parts

Full Voltage Adapter

Shape	Series	Description	Part No.
	SLC30	LED	SLDN-3DH
		Incandescent	SLC-3DS
	SLC40	LED	SLDN-4DH
		Incandescent	SLC-4DE

Transformer Unit

Shape	Series	Illumination	Primary Voltage (50/60 Hz)	Applicable LED Unit/ Incandescent Lamp	Part No.
	SLC30	LED	100/110V AC	SLDN-32M-*	SLDN-3TH1
			200/220V AC		SLDN-3TH2
	SLC30	Incandescent	100/110V AC	LS-6	SLC-3TS1
			200/220V AC		SLC-3TS2
	SLC40	LED	100/110V AC	SLCN-42M-*	SLDN-4TH1
			200/220V AC		SLDN-4TH2
	SLC40	Incandescent	100/110V AC	LE-6	SLC-4TE1
			200/220V AC		SLC-4TE2

Separate Transformer (24V output, LED Unit)

Shape	Primary Voltage	Secondary Voltage	Part No.	Applicable LED Unit/ Lamp
	100/110V AC	0.5W, 24V	TWR512	See the table below.
	200/220V AC	0.5W, 24V	TWR522	
	400/440V AC	0.5W, 24V	TWR542	

• Terminal cover (Part No. TWR-VL3) is supplied as standard.

Applicable LED Unit/Lamp

Series	LED Part No.	Applicable Model
SLC30	LED Unit	SLDN-32M-* One-color full (one unit per transformer)
		SLDN-32MW-RG Two-color alternate (one unit per transformer)
	LED Lamp	LFTD-2* Type C (up to two lamps per transformer)
SLC40	LED Unit	SLCN-42M-* LED one-color full (one unit per transformer)
		SLCN-42MW-RG Two-color alternate (one unit per transformer)
	LED Lamp	LSTD-2* Type C (one unit per transformer)

• Specify a color code in place of *. See page 29.

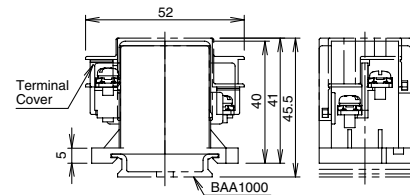
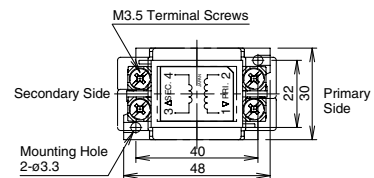

Dimensions



All dimensions in mm.

SLC30/40 Series Combination Display Lights Accessories

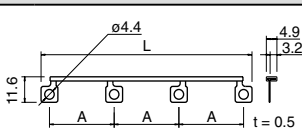
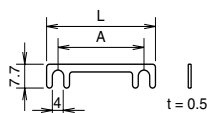
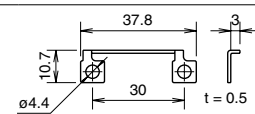
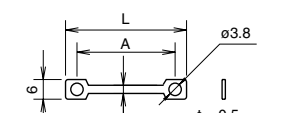
Accessories / Replacement Parts

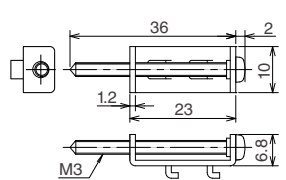
Name & Shape	Part No.	Ordering No.	Description & Dimensions	Package Quantity													
Jumper for fingersafe, Spring-up Terminal  Rated Current: 3A (Supplied)	SLCN-JP34	SLCN-JP34PN10	For SLC30 Terminal X1, X2	 <table border="1"> <thead> <tr> <th>Part No.</th> <th>L</th> <th>A</th> </tr> </thead> <tbody> <tr> <td>SLCN-JP34</td> <td>97.8</td> <td>30</td> </tr> <tr> <td>SLCN-JP44</td> <td>128</td> <td>40</td> </tr> </tbody> </table>	Part No.	L	A	SLCN-JP34	97.8	30	SLCN-JP44	128	40				
	Part No.	L	A														
	SLCN-JP34	97.8	30														
	SLCN-JP44	128	40														
SLCN-JP44	SLCN-JP44PN10	For SLC40 Terminal X1, X2															
Ring Terminal (for 2 windows) Rated Current: 3A (Supplied)	SLCN-JP35	SLCN-JP35PN10	For SLC30 Terminal X1, X2														
	SLCN-JP45	SLCN-JP45PN10	For SLC40 Terminal X1, X2														
Spade Terminal Rated Current: 3A (Supplied)	SLC-JP30	SLC-JP30PN10	For SLC30 Terminal X1	 <table border="1"> <thead> <tr> <th>Part No.</th> <th>L</th> <th>A^{±0.1}</th> </tr> </thead> <tbody> <tr> <td>SLCN-JP30</td> <td>38</td> <td>30</td> </tr> <tr> <td>SLCN-JP40</td> <td>48</td> <td>40</td> </tr> </tbody> </table>	Part No.	L	A ^{±0.1}	SLCN-JP30	38	30	SLCN-JP40	48	40				
	Part No.	L	A ^{±0.1}														
SLCN-JP30	38	30															
SLCN-JP40	48	40															
SLC-JP40	SLC-JP40PN10	For SLC40 Terminal X1															
Jumper for Other Terminals	SLC-JP33	SLC-JP33PN10	For SLC30 Terminal X2 or Terminal X1 of Type C														
	SLC-JP41	SLC-JP41PN10	For SLC40 Terminal X2														
	Ring Terminal Rated Current: 3A	SLC-JP32	SLC-JP32PN10	For SLC30 Terminal C (check terminal & 2-color alternate)	 <table border="1"> <thead> <tr> <th>Part No.</th> <th>L</th> <th>A^{±0.1}</th> <th>B</th> </tr> </thead> <tbody> <tr> <td>SLCN-JP32</td> <td>37</td> <td>30</td> <td>2.5</td> </tr> <tr> <td>SLCN-JP42</td> <td>47</td> <td>40</td> <td>2.5</td> </tr> </tbody> </table>	Part No.	L	A ^{±0.1}	B	SLCN-JP32	37	30	2.5	SLCN-JP42	47	40	2.5
		Part No.	L	A ^{±0.1}		B											
SLCN-JP32	37	30	2.5														
SLCN-JP42	47	40	2.5														
SLC-JP42	SLC-JP42PN10	For SLC40 Terminal C (check terminal & 2-color alternate)															
Mounting Clips  (Supplied)	SLC-3K1	SLC-3K1PN10	Used for fastening SLC units to panel cut-out from the rear of the panel. Weight: approx. 4.6g														

All dimensions in mm.

Jumper Application Examples

On Fingersafe, Spring-up Terminals



On Other Terminals

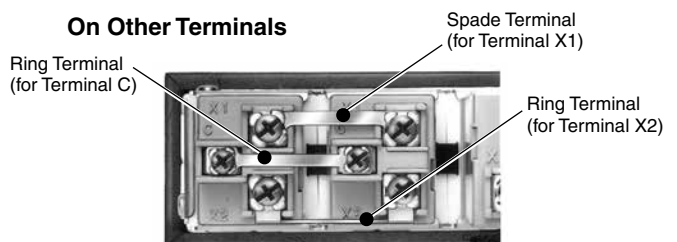

SLC30/40 series Combination Display Lights Instructions



Safety Precautions

- Turn off the power to the SLC units before installation, removal, wiring, maintenance, or inspection. Before removing the LED units or incandescent lamps, make sure that power is turned off. Failure to turn off the power may cause an electrical shock, create fire hazards, or damage of LED units or incandescent lamps. Do not use the SLC units without the lens, otherwise ingress of foreign objects may cause short circuit, and LED units may be damaged resulting in the deterioration of LED brightness or no lighting.
- When lighting the SLC units continuously, observe the conditions described below. If the limits are exceeded, the SLC units may heat up and create fire hazards or damage the SLC units.
- To avoid burning your hand, use the lamp holder tool when replacing incandescent lamps.
- For wiring, use wires of a proper size to meet the voltage and current requirements and tighten the terminal screws to the tightening torque shown below. Loose terminal screws may cause excessive heating, resulting in fire hazards.
- Do not install or operate the SLC units where the SLC units are subjected to direct sunlight. Excessive heating may create fire hazards or damage the SLC units.
- When replacing LED units, LED lamps, or incandescent lamps, use IDEC products.

Operating Instructions

Notes for Continuous Lighting

Up to 10 SLC units (Type F equivalent) can be lit continuously. When more units are mounted, consider the following restrictions.

LED illuminated full voltage

Incandescent illuminated full voltage

- Do not light more than 40% of the SLC units continuously, and light the units in a checker pattern.
- When more than 40% of the units are lit continuously, limit the lighting duration to 40 minutes. Before lighting the units again, ensure that all units have cooled down.
- When using 2-color alternate units, do not light the two colors simultaneously.

LED/Incandescent illuminated

Transformer and DC-DC converter

- Light the units in a flashing or checker pattern.

When using the SLC units in other conditions, contact IDEC.

Notes for Panel Mounting

- When mounting the SLC units on a panel, determine the panel thickness taking the weights of the SLC units and wires into consideration.

Tightening Torque for Terminal Screws

- For wiring, use wires of a proper size to meet the voltage and current requirements and tighten the terminal screws to the tightening torque shown below.

Terminal Screw	Tightening Torque
M3	0.6 to 1.0
M3.5	1.0 to 1.3 N·m
M4	1.4 to 2.0 N·m

<Storage and Handling>

- Do not use the SLC where it is subjected to condensation caused by extreme temperature change.
- Do not use chemicals such as alcohol that degrade the property of acrylic.

<Operating Instructions>

- The illumination color may change depending on the decreasing brightness of LED, along with the period of use.
- The SLC can be used indoors only. Do not use outdoors.

SLC30/40 Series Combination Display Lights Instructions

Operating Instructions

When Using Blue and Green LED Units

When replacing LED units, avoid ESD to the LED pins, otherwise the internal LED elements may become damaged.

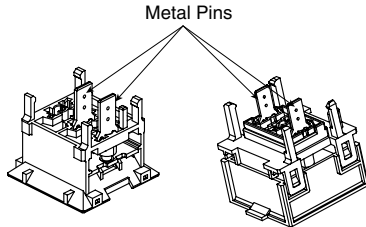

Precautions for Noise

When using the SLC units in an environment where the SLC is subjected to noise, connect a noise suppressor across terminals X1 and X2 as shown below.

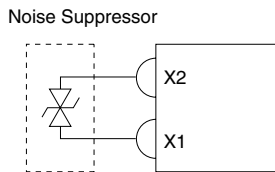

Notes for Using LED Units

Countermeasures against dim lighting

The SLC units contain a provision against dim lighting due to leakage current. If the LED unit appears to be dimly lit due to induced current from nearby AC lines, take appropriate countermeasures as described below.

[Sample Circuit]

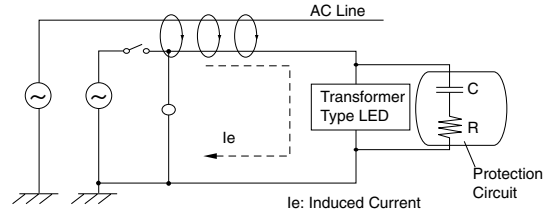

[Countermeasure]

As shown in the diagram above, connect an RC circuit in parallel with the transformer LED unit. For the values of the resistor and capacitor, see the following table.

	Operating Voltage	Capacitor C (μF)	Resistor R	
			(Ω)	(W)
SLC30	100/110V AC (50/60 Hz)	0.33	120	0.25
	200/220V AC (50/60 Hz)	0.10	120	0.25
SLC40	100/110V AC (50/60 Hz)	0.22	120	0.25
	200/220V AC (50/60 Hz)	0.10	120	0.25

LED Unit Internal Circuit

SLC30 Series

- SLDN-36M-* (6V AC/DC)
- SLDN-31M-* (12V AC/DC) One-color full (amber, green, red, yellow)
- SLDN-36M-W (6V AC/DC) One-color full (white)
- SLDN-31M-W (12V AC/DC) One-color full (white)

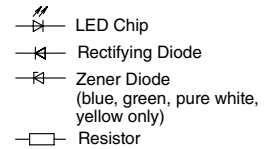
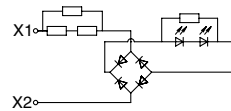
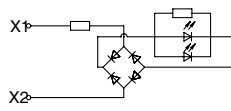
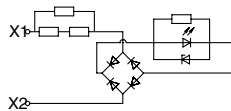

- SLDN-32M-* (24V AC/DC) One-color full (amber, blue, green, red, yellow)
- SLDN-32-W (24V AC/DC) One-color full (white)
- SLDN-32MW-RG (24V AC/DC) Two-color alternate
- SLDN-32ST-* (24V AC/DC) Spot illumination

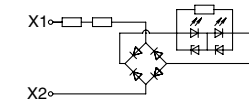
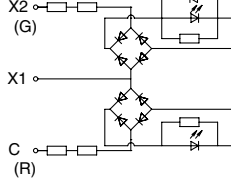
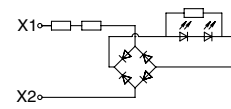
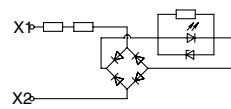

SLC40 Series



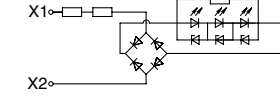
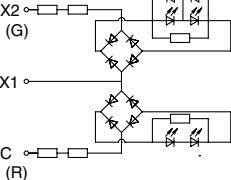
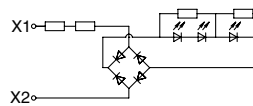
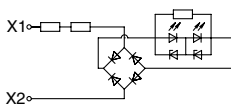







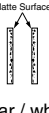









- SLDN-42M-* (24V AC/DC) One-color full (amber, blue, green, red, yellow)
- SLDN-42-W (24V AC/DC) One-color full (white)
- SLDN-42MW-RG (24V AC/DC) Two-color alternate
- SLDN-42ST-* (24V AC/DC) Spot illumination











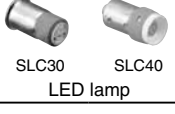

SLC30/40 series Combination Display Lights Instructions

Operating Instructions

Type F, H, H2, L, V, G

Display Color Type	Light Source	Marking Plate/ Color Screen (Note 1) (Note 2)	Lens	ON Color (Color Code)	OFF Color
Standard (using clear lens)	 SLC30 SLC40 LED unit	 Matte Surface clear / white	 clear lens	amber (A), blue (S), green (G), pure white (PW) (Type F only), red (R), white (W), yellow (Y) red/green (two-color alternate) (RG) (no spot illumination for red/green two-color alternate)	White
	 SLC30 SLC40 Incandescent lamp	 Matte Surface color / white	 clear lens	amber (A), blue (S), green (G), red (R), yellow (Y) (Note 3)	
	 SLC30 SLC40 Incandescent lamp	 Matte Surface clear / white	 clear lens	white (W)	
Color Screen	 SLC30 SLC40 LED unit	 Matte Surface white / color	 clear lens	amber (TA), blue (TS), green (TG), red (TR), yellow (TY),	Same as ON color
	 SLC30 SLC40 LED unit	 Matte Surface clear / white	 clear lens	pure white (TPW, Type F only), white (TW)	
Gray Lens (Note 4)	 SLC30 SLC40 LED unit	 Matte Surface clear / black (Note 5)	 gray lens	amber (SA), blue (SS), green (SG), pure white (SPW, Type F only), red (SR), white (SW), yellow (SY)	Gray
	 SLC30 SLC40 Incandescent lamp	 Matte Surface color* / black (Note 5) (* clear for white (SW))	 gray lens	amber (SA), blue (SS), green (SG), red (SR), white (SW), yellow (SY)	

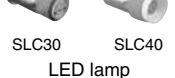
Type C (split-window)

Display Color Type	Light Source	Marking Plate/ Color Screen (Note 1) (Note 2)	Lens	ON Color (Color Code)	OFF Color
Standard (using clear lens)	 SLC30 SLC40 LED lamp	 Matte Surface color / white	 clear lens	amber (A), blue (S), green (G), red (R), yellow (Y) (Note 3)	White
	 SLC30 SLC40 LED lamp	 Matte Surface white / clear	 clear lens	pure white (PW), white (W)	
Gray Lens (Note 4)	 SLC30 SLC40 LED lamp	 Matte Surface color / black (Note 5)	 gray lens	amber (SA), blue (SS), green (SG), red (SR), yellow (SY)	Gray
	 SLC30 SLC40 LED lamp	 Matte Surface clear / black (Note 5)	 gray lens	pure white (SPW), white (SW)	

Note 1: Place the marking plate and color screen with the matte surfaces facing each other. The insertion order can be interchanged if necessary. Engrave on the flat surface of the screen/plate next to the lens.

Note 2: See page 27 for ordering the screen/plate as replacement parts.

Note 3: When color screen display (color shown when OFF) is necessary, change the insertion order of screen/plate as follows.
amber (A), blue (S), green (G), red (R), yellow (Y): light source → white plate → color screen → clear lens

Note 4: When ON: legends shown in the specified color on gray lens. When OFF: no legends shown on gray lens. Gray lens, black marking plate, and clear or color screen are used.

Note 5: Black marking plate has black coating. Engrave a reverse legend on the black-coated surface.

SLC30/40 Series Combination Display Lights Instructions

Type F Spot Illumination

Spot illumination LED unit and spot illumination kit are used.

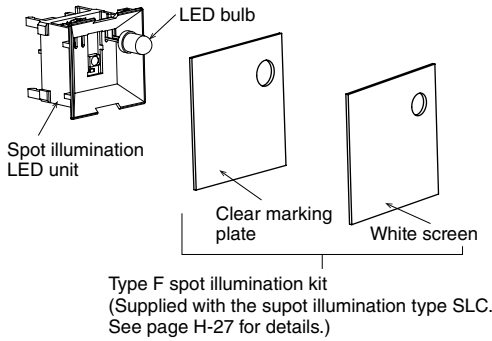

Marking on Films

In addition to white color screens or clear marking plates, legends can be engraved on thin marking films on Type F windows. Two sheets of 0.1-mm-thick films or one sheet of 0.2-mm-thick films is applicable. Marking films are not supplied with the SLC units and must be prepared by the user.

Dimensions

SLC30N: 27 × 27 mm
SLC40N: 35.8 × 35.8 mm

Film Material

Polyester is recommended.

Placement of Marking Film

When using a marking film, place the matte surfaces of the marking plate and color screen in the same direction to make a room of 0.2 mm for the marking film (matte surfaces are not facing each other). When not using a marking film, face the matte surfaces of marking plate and color screen each other.

Using a marking film

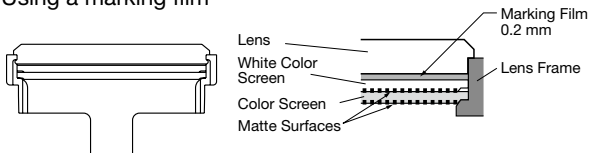

Not using a marking film

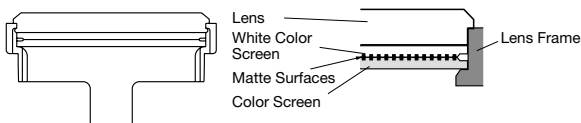

Color Screen/White Color Screen/Clear Screen Dimensions

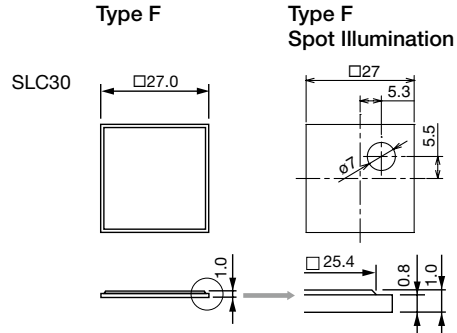

For engraving area, see page 7.

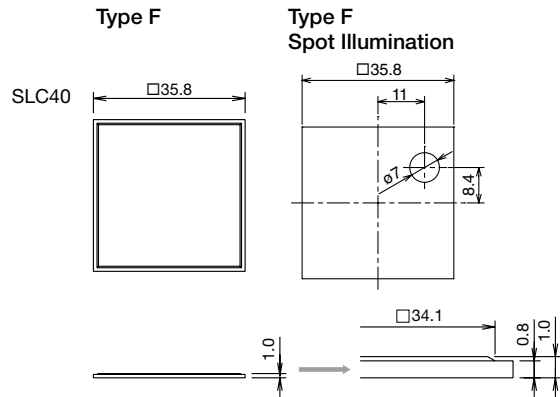

For engraving area, see page 17.

All dimensions in mm.

SLC30/40 series Combination Display Lights Instructions

Operating Instructions

Removing the Windows

SLC30 Series

To remove the display window, insert the tip of a flat screwdriver into the slot on the bottom of the lens frame, and press down lightly on the screwdriver as shown.

For types G and V, do not put excessive force to remove one latch while pressing the other latch on the opposite side.

SLC40 Series (Extensible Windows)

The extensible window, featured on all SLC40 series units except Types C, G, and L, can be removed simply by pulling the upper portion out of the housing. For Types C, G, and L, insert the tip of a flat screwdriver into the slot on the bottom of the lens frame, and press up lightly.

When installing Type C windows, face the retaining latch with TOP marking upward.

All windows are shipped with the window retracted. After the windows are installed in a panel, they can be extended as required starting from the lowest row to the top row. Beware of the orientation when installing the units. When transporting the units, hold all windows in the retracted position.

SLC30 Series

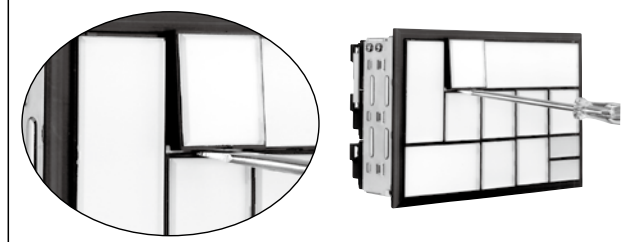

SLC40 Series

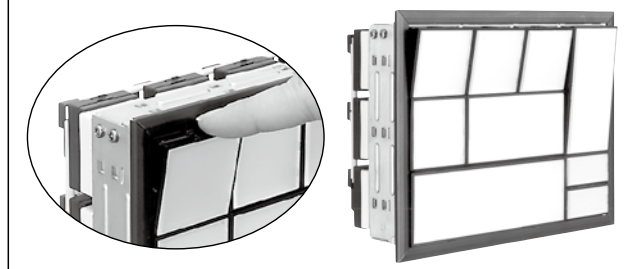

Maximum Number of Windows

SLC30 Series

LED Unit

- Full Voltage, w/Check Terminal, 2-color Alternate
Up to 10 rows/26 columns (windows must be 200 at maximum)

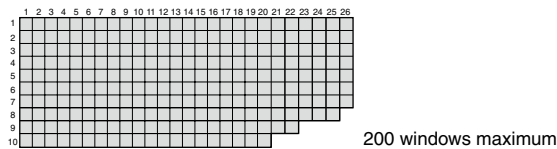

LED Unit

- Transformer, Flasher, DC-DC Converter, Resistor
Up to 10 rows/26 columns (windows must be 75 at maximum)

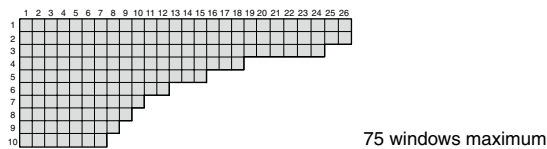

SLC40 Series

LED Unit

- Full Voltage, w/Check Terminal, 2-color Alternate
Up to 7 rows/24 columns (windows must be 126 at maximum)

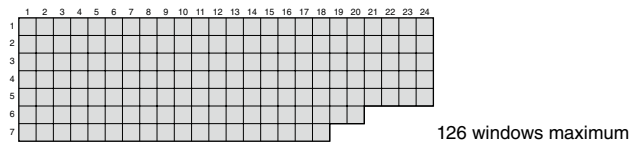

LED Unit

- Transformer, Flasher, DC-DC Converter, Resistor
Up to 7 rows/24 columns (windows must be 60 at maximum)

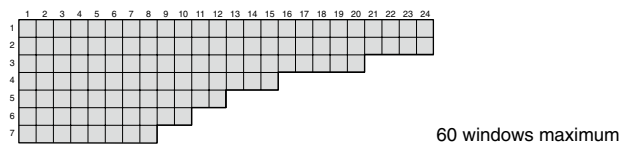

Incandescent Lamp

- Full Voltage
Up to 10 rows/20 columns

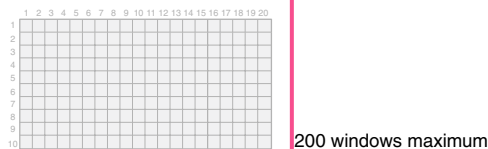

LED Lamp (Type C)

- Full Voltage

Incandescent Lamp

- Transformer, Resistor
Up to 10 rows/20 columns (windows must be 50 at maximum)

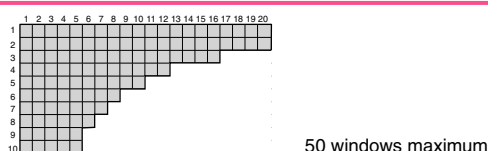

LED Lamp (Type C)

- Full Voltage

Incandescent Lamp

- Full Voltage, w/Check Terminal, 2-color Alternate
Up to 7 rows/15 columns

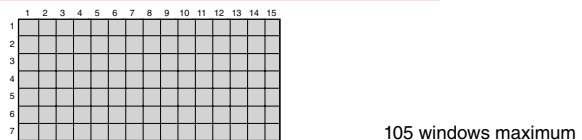

Incandescent Lamp

- Transformer, Resistor
Up to 7 rows/15 columns (windows must be 50 at maximum)

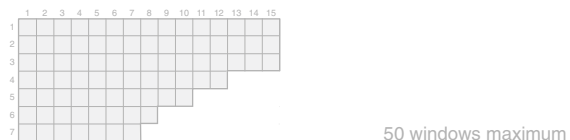

SLC30/40 Series Combination Display Lights Instructions

Replacing Lens, Marking Plate, and Color Screen

[Removal]

The lens has retaining projections (one or two each on right and left sides). To remove the lens, marking plate, and color screen from the lens frame, push open the lens frame with both hands as shown.

The lens can also be removed by inserting a screwdriver into one of the sides with recesses. Since the lens has an orientation due to projections, be sure to insert the screwdriver in the direction as shown.

Note: Take care not to damage or scratch the lens surface.

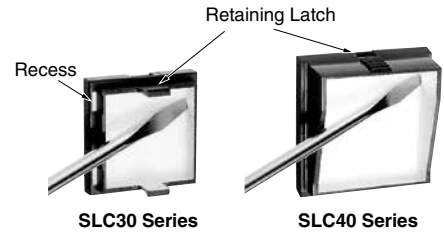
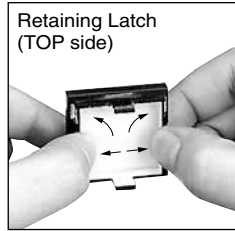

Retaining Projections Location

Series	Type F, G	Type C	Type H	Type L	Type V
SLC30 Series					
SLC40 Series (Extensible Windows)					

[Installation]

Install the color screen and marking plate into the lens frame.

To install the lens, insert its retaining projections into the recesses inside the lens frame, and press the lens on the other side into the lens frame.



Replacing the LED Unit

Ensure that power to the display lights has been turned off before removing the LED unit.

[Removal]

Use the LED unit removal tool (MT-101) to pull out the LED unit. For SLC30 units, pinch the top and bottom sides of the unit. For SLC40 units, pinch the right and left sides of the unit.

Note: When removing the LED unit from the housing, pull it out straight without pressing on the LED unit terminals.

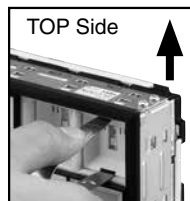

[Installation]

The LED unit has an orientation. To install the LED unit, place the metal pins on the LED unit to fit into the receptacles in the housing, and insert the LED unit.

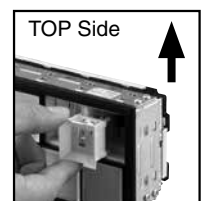

LED Unit Color Identification

Each LED unit has part no. and identification mark stamped.

Color	Code	Mark	Appearance	
			SLC30	SLC40
Red	R	● Red dot		
Green	G	● Green dot		
Amber	A	● Amber dot		
Blue	S	● Blue dot		

Color	Code	Mark	Appearance	
			SLC30	SLC40
Yellow	Y	P (Note)		
White	W	W		
Pure White	PW	P		
Red/ Green	RG	—		

Note: Yellow (Y) LED unit uses a pure white LED unit with a yellow filter on the LED.

SLC30/40 series Combination Display Lights Instructions

Replacing LED Lamps

SLC30, Type C

[Removal]

Push lamp holder tool OR-44 into the LED lamp kit, and push and turn clockwise to remove the lamp from the lamp holder.

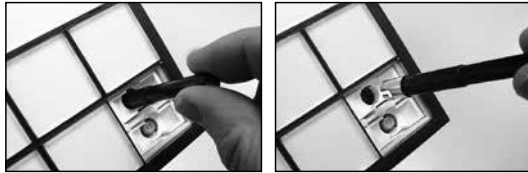

[Installation]

Insert the lamp into the lamp holder completely (lamps can be installed easily by using the handle part of lamp holder tool).

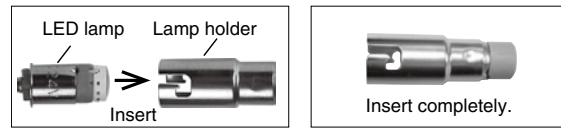

Insert the lamp holder tool into the lamp holder.



Align the insertion guides of the lamp holder with the grooves in the SLC unit. Push the lamp lightly and turn clockwise to install.

SLC40, Type C

Lamps can be replaced easily by using the lamp holder tool OR-55. When removing the lamp, reflector does not have to be removed.

Installation on Panel

Insert the units into a panel cut-out from the front, and install the mounting clips supplied with the units from the back as shown below. Apply loctite on the screws to prevent loosening. The number of mounting screws varies with the number of windows. Tighten the screws to a torque of 0.39 N·m to 0.49 N·m.

Example of Mounting Clip Positions (■)

Columns \ Rows	1	2	3 to 8	9 to 15	16 to 22	23 to 26
1 to 2	(Note)					
3						
4 to 6						
7 to 10						

Note: See below for Type V.

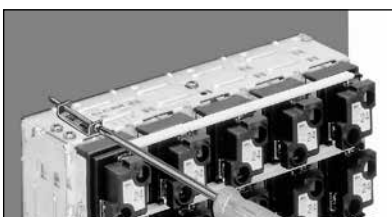

No. of Mounting Clips

Columns \ Rows	1 to 2	3 to 8	9 to 15	16 to 22	23 to 26
1 to 2	2	4 (6)	6 (8)	8	10
3 to 6	4 (6)	6 (8)	8 (10)	10 (12)	12 (14)
7 to 10	6 (8)	8 (10)	10 (12)	12	14

Note: Numbers in () show the number of mounting clips required for transformer, resistor, flicker, and DC-DC converter.

SLC30/40 Series Combination Display Lights Instructions

SLC30/40 Series Combination Display Lights Specification Sheet

Date of Order	
Customer	
Address	
Phone No.	
Contact	

Part No.

Color Code Designations

SLC N- - B -

A (), G (), PW (), R (), S (), W (), Y ()
 TA (), TG (), TPW (), TR (), TS (), TW (), TY ()
 SA (), SG (), SPW (), SR (), SS (), SW (), SY ()

Illumination Face Size & Color Screen Code Designations

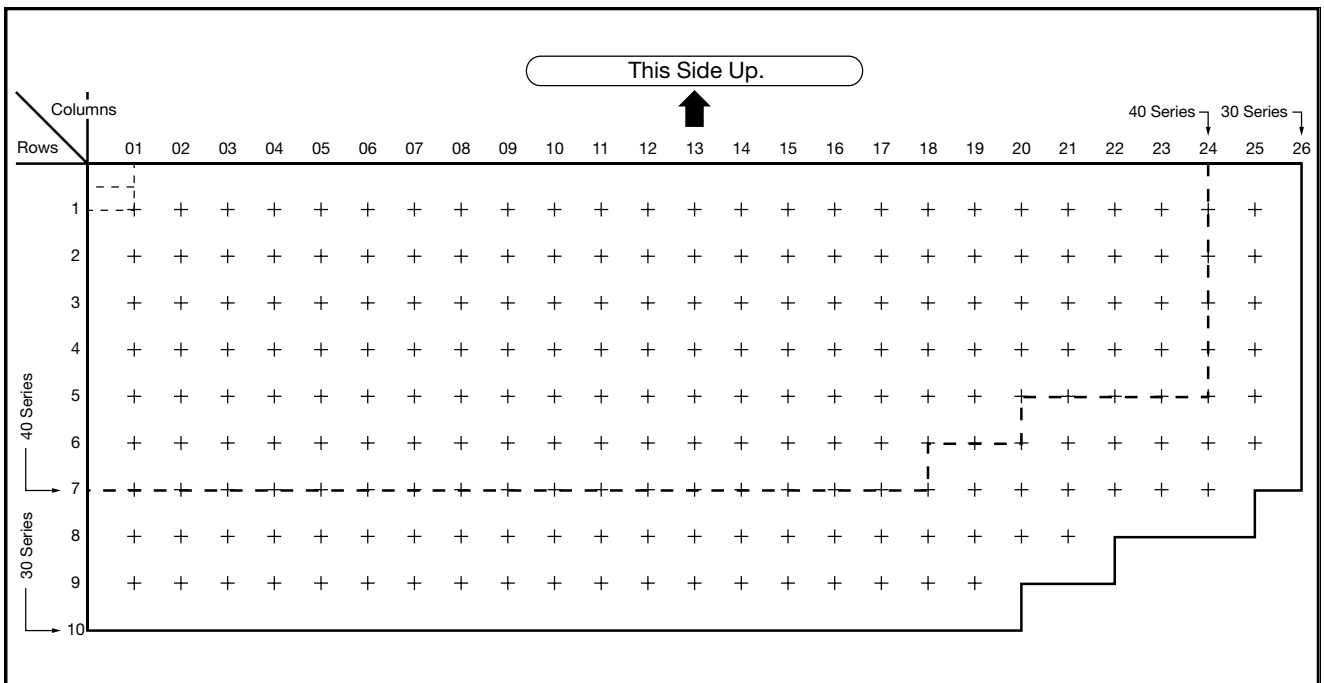

Part No. Development

SLC N- - B -

Color Designations
 A (0), G (5), PW (1), R (6), S (5), W (0), Y (5)
 TA (), TG (), TPW (), TR (), TS (), TW (), TY ()
 SA (5), SG (0), SPW (), SR (0), SS (0)SW (2), SY (5)

Frame Color
 B: Black (N1.5 Equivalent)

Illumination Face Size
 F, H, H2, L, V, G, M, C, FST

Color Code
 When designating M, H2 for illumination face size code, or two or more LED colors, mark in the above table.

Voltage

LED Illumination		
6: 6V AC/DC ±5% (except for SLC40N)	1: 100/110V AC ±10% (transformer)	1: 110V DC (converter)
1: 12V AC/DC ±10%	2: 200/220V AC ±10% (transformer)	1: 100/110V AC/DC (resistor)
2: 24V AC/DC ±10%		

Incandescent Illumination

6: 5 to 6V	1: 100/110V AC ±10% (transformer)	1: 100/110V AC/DC (resistor)
8: 12 to 18V	2: 200/220V AC ±10% (transformer)	
2: 18 to 24V		
3: 24 to 30V (recommended for 24V operating voltage)		

Type

LED Illumination	
DD: SLC30/40 (Full Voltage)	CD: SLC30/40 (DC-DC Converter)
DHM: SLC30/40 (Full Voltage w/Check Terminal)	RN: SLC30/40 (Resistor)
DW: SLC30/40 (2-color alternate)	RNA: SLC30/40 (Blue/pure white Resistor)
DF: SLC30/40 (Flasher Type)	DDA: SLC30/40 (Blue/pure white Full Voltage)
DP: SLC30/40 (Split-window, Type C)	TDA: SLC30/40 (Blue/pure white Transformer)
TD: SLC30/40 (Transformer)	

Incandescent Illumination

DS: SLC30 (BA9S Base Full Voltage)	RS: SLC30 (BA9S Resistor)
DE: SLC40 (E12 Base Full Voltage)	RE: SLC40 (E12 Resistor)
TS: SLC30 (BA9S Transformer)	DB: SLC40 (BA9S Full Voltage, Dual Lamp)
TE: SLC40 (E12 Transformer)	DEM: SLC40 (E12 Full Voltage w/Check Terminal)

No. of Windows: A B

(Type C)

R →
G

SLC30 Series Combination Display with Control Units

Combination of display lights and control units reduce labor of switch installation and minimizes installation space.

Switch for lamp test, external switch for system display can be integrated into the frame of combination display lights.

- Various control units can be installed in the window frame, with or without SLC units.
- Panel space can be reduced.
- Labor and time to install switches can be reduced.
- Flexibility of panel design is maximized.
- Up to 30 windows (3 rows × 10 columns) can be used.

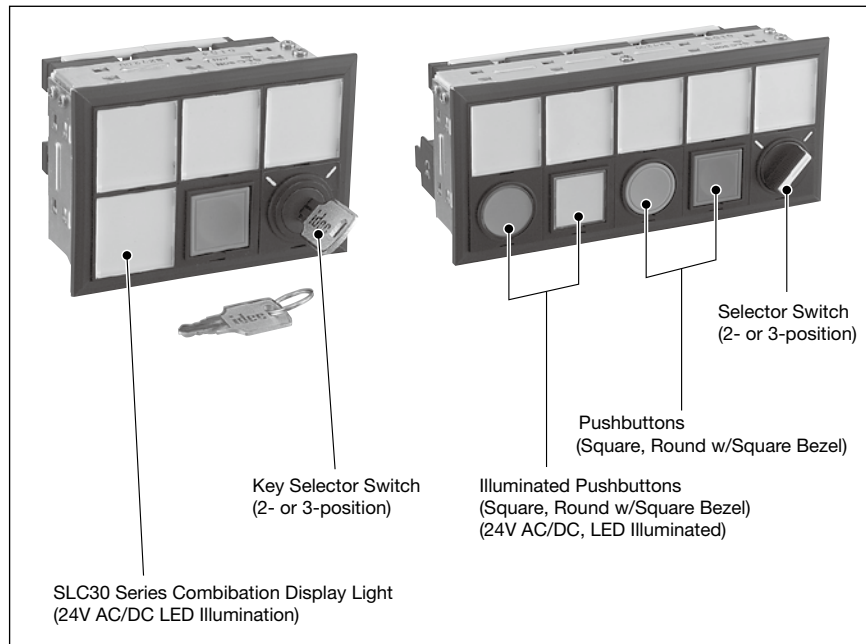

Combination Display Lights

- LED Illumination
- One-color Full, Type F (30 × 30mm)
- Operating voltage: 24V AC/DC
- Illumination color:
Amber (A), Blue (S), Green (G), Pure White (PW), Red (R), White (W), Yellow (Y)
- Frame color: Black (B)

Control Unit (SLC30-LW)

Pushbutton (Square, Round w/Square Bezel)

- Contact: DPDT (gold or silver)
- Operation: Momentary
- Button color:
Black (B), Green (G), Red (R), Blue (S), White (W), Yellow (Y)

Illuminated Pushbutton

(Square, Round w/Square Bezel)

- Contact: DPDT (gold or silver)
- Operation: Momentary
- Illumination color:
Amber (A), Green (G), Pure White (PW), Red (R), Blue (S), White (W), Yellow (Y)

Selector Switch (Round w/Square Bezel)

Key Selector Switch (Round w/Square Bezel)

- Contact: DPDT (gold or silver)
- Operation: 2 or 3-position, maintained

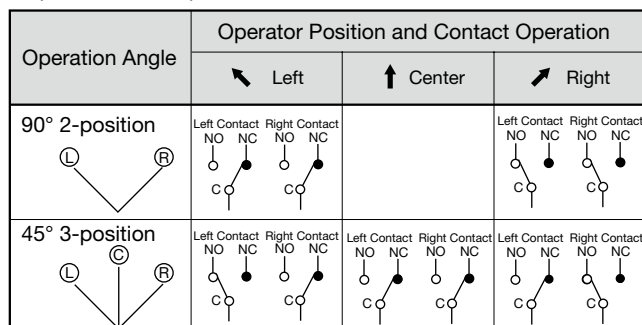

Specifications

Connection Wire	SLC30: Solid wire $\phi 1.6 \times 2$ Stranded wire $2 \text{ mm}^2 \times 2$ SLC-LW: Stranded wire 1.25 mm^2 maximum
Terminal Screw	SLC30: M3.5 SLC30-LW: M3.0
Insulation Resistance	100 M Ω minimum (500V DC megger)
Dielectric Strength	SLC30: 2000V AC, 1 minute
	SLC30-LW: 2500V AC, 1 minute (between terminals of the same pole: 1000V AC, 1 minute)
Operating Temperature	-20 to 40°C (no freezing)
Storage Temperature	-25 to +60°C (no freezing)
Operating Humidity	45 to 85% RH (no condensation)

Contact Ratings

Rated Insulation Voltage	250V AC/DC
Rated Current	Gold contact: 3A Silver contact: 5A
Operating Voltage/Current	Gold contact: 125V AC/0.1A, 30V DC/0.1A (resistive load) Silver contact: 125V AC/3A, 250V AC/2A 30V DC/2A, 125V DC/0.4A (resistive load)

Combination Display Light Ratings

Operating Voltage	24V AC/DC
Rated Current	Amber, red, white : 12 mA Blue, green, pure white, yellow: 11 mA

SLC30 Series Combination Display with Control Units

Dimensions

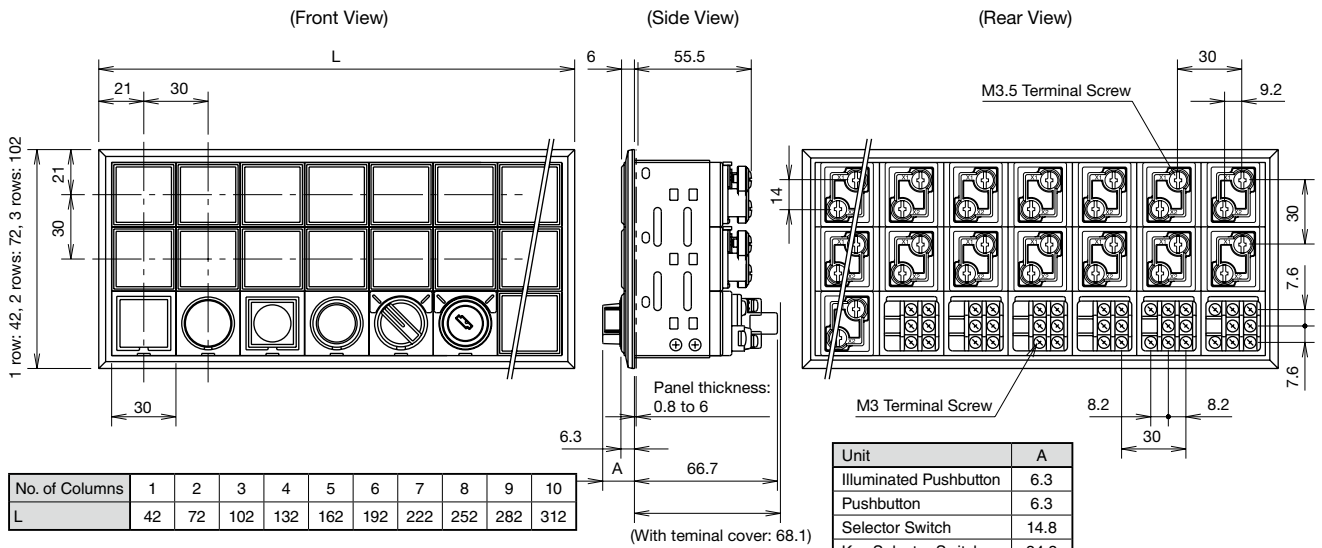

All dimensions in mm.

Panel Cut-out

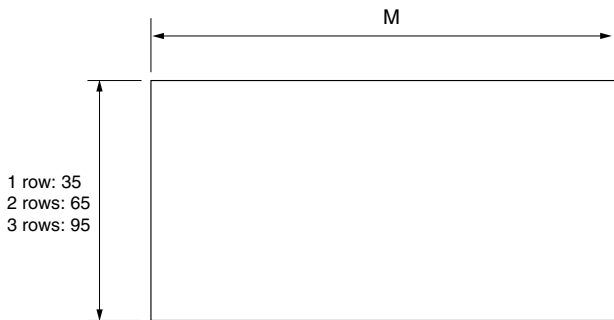

No. of Columns	1	2	3	4	5	6	7	8	9	10
M (mm)	35	65	95	125	155	185	215	245	275	305

Panel Cut-out (Bottom View)

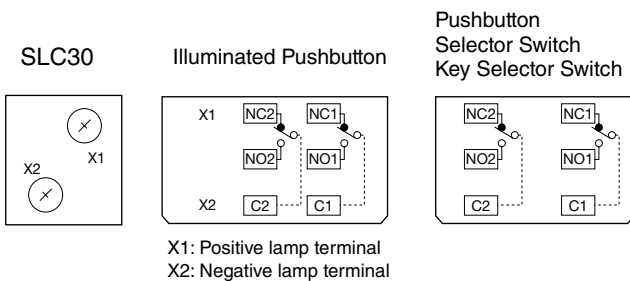

Ordering Information

- When ordering, complete the Specification Sheet on page 39.
- Control units (SLC30-LW) can be mounted on the bottom row only.
- Jumpers (SLCN-JP34/-JP35) are used between combination display lights only. Jumpers can not be used between control units, or between control units and combination display lights.
- See page 27 to 29 for accessories.
- Minimum unit size is 2 × 1 windows.



Safety Precautions

See page 32.

Operating Instructions

- When using the insulation terminal cover (LW-VL2M) for the control units
 - Install the terminal cover on the SLC units before wiring. Terminal covers cannot be installed after wiring.
 - Ring crimping terminals cannot be installed when terminal covers are used. Use spade terminals or wire directly.
- Do not remove the operator part of control units from the housing. Otherwise contacts may malfunction.
- On key selector switches, do not attempt to remove the key at any key retained position with excessive force (more than approx. 70N). Otherwise the operator part detaches from the housing, causing the contacts to malfunction.
- Use a lamp holder tool (OR-55) when replacing lamps for control units.
- For wiring, use wires of a proper size to meet the voltage and current requirements. Tighten the M3.5 terminal screws to a tightening torque shown below.

Terminal Screw	Recommended Tightening Torque
M3	0.6 to 1.0 N·m
M3.5	1.0 to 1.3 N·m

- Up to 10 SLC units (Type F equivalent) can be lit continuously. When more units are mounted, consider the following restrictions.
 - Do not light more than 40% of the SLC units continuously, and light the units in a checker pattern.
 - When more than 40% of the units are lit continuously, limit the lighting duration to 40 minutes. Before lighting the units again, ensure that all units have cooled down.
- For other operating instructions of display lights, see the relevant pages of SLC30/40 catalog.
- For other operating instructions of control units, see the relevant pages of ø22 LW control unit catalog.

SLC30 Series Combination Display with Control Units

SLC30/40 Series Combination Display Lights with Control Units Specification Sheet

Date of Order	
Customer	
Address	
Phone No.	
Contact	

Part No.

SLC30N- -DD2ML -

For illumination color and control unit, enter your requirements in the diagram below.

Illumination Color & Control Unit Specification

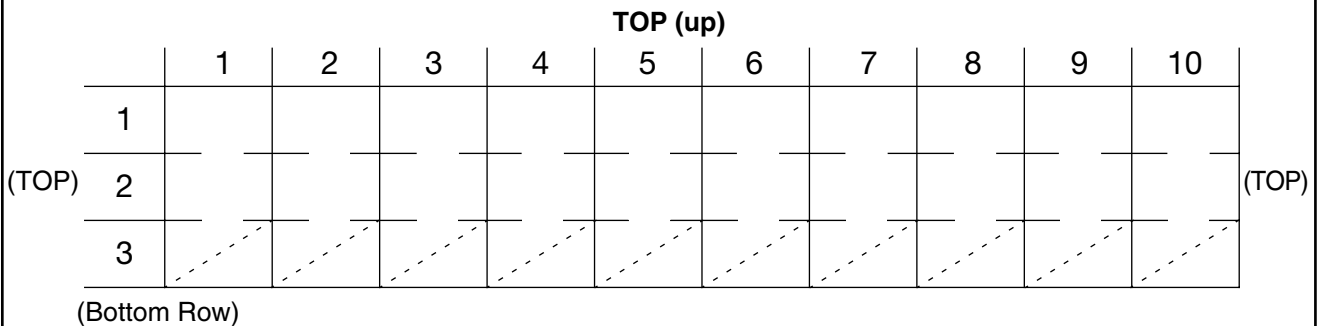

Specification Notes

- Use the specification diagram above for LED one-color Full (24V AC/DC) only.
- Control units can be mounted on the bottom row (the third row in the diagram above) only. Enter button or lens color code in the upper part and control unit code in the lower part (see the table below for control unit code). Display lights can be specified on the bottom row.
- Specify the TOP position (mounted onto the panel).

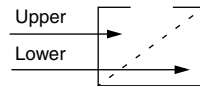

Control Unit Code

Code	Style (gold contact)	Code	Style (silver contact)
1	Square Illuminated Pushbutton (DPDT)	2	Square Illuminated Pushbutton (DPDT)
3	Round w/Square Bezel Illuminated Pushbutton (DPDT)	4	Round w/Square Bezel Illuminated Pushbutton (DPDT)
5	Square Pushbutton (DPDT)	6	Square Pushbutton (DPDT)
7	Round w/Square Bezel Pushbutton (DPDT)	8	Round w/Square Bezel Pushbutton (DPDT)
9	Selector Switch (2-position)	10	Selector Switch (2-position)
11	Selector Switch (3-position)	12	Selector Switch (3-position)
13*	Key Selector Switch (2-position)	14*	Key Selector Switch (2-position)
15*	Key Selector Switch (3-position)	16*	Key Selector Switch (3-position)

* Refer to the below table for key retaining positions.

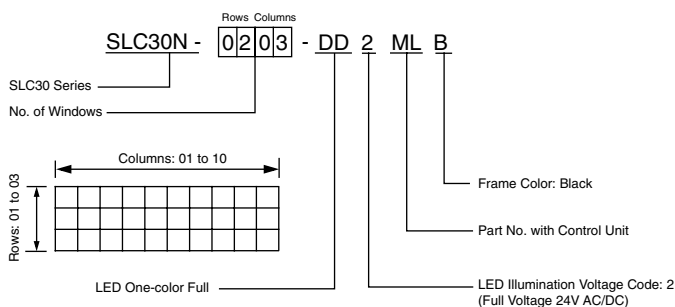

Key Code	A	B	C	Ⓐ Ⓑ Ⓒ:			
2-position Maintained				Key can be released from these positions.			
Key Code	A	B	C	D	E	G	H
3-position Maintained							

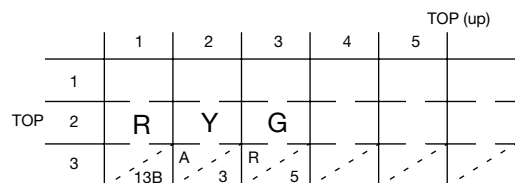

Specifications and other descriptions in this brochure are subject to change without notice.



IDEC CORPORATION

6-64, Nishi-Miyahara 2-Chome, Yodogawa-ku, Osaka 532-0004, Japan
Tel: +81-6-6398-2527, Fax: +81-6-6398-2547
E-mail: marketing@idec.co.jp

IDEC CORPORATION (USA)

1175 Elko Drive, Sunnyvale, CA 94089-2209, USA
Tel: +1-408-747-0550 / (800) 262-IDECE (4332)
Fax: +1-408-744-9055 / (800) 635-6246
E-mail: opencontact@idec.com

IDEC CANADA LIMITED

3155 Pepper Mill Court, Unit 4
Mississauga, Ontario, L5L 4X7, Canada
Tel: +1-905-890-8561, Toll Free: (888) 317-IDECE (4332)
Fax: +1-905-890-8562
E-mail: sales@ca.idec.com

IDEC AUSTRALIA PTY. LTD.

Unit 17, 104 Ferntree Gully Road,
Oakleigh, Victoria 3166, Australia
Tel: +61-3-8523-5900, Toll Free: 1800-68-4332
Fax: +61-3-8523-5999
E-mail: sales@au.idec.com

IDEC ELEKTROTECHNIK GmbH

Heselerstrucken 8, 22453 Hamburg, Germany
Tel: +49-40-25 30 54 - 0, Fax: +49-40-25 30 54 - 24
E-mail: service@eu.idec.com

IDEC (SHANGHAI) CORPORATION

Room 701-702 Chong Hing Finance Center,
No. 288 Nanjing Road West, Shanghai 200003, PRC
Tel: +86-21-6135-1515
Fax: +86-21-6135-6225 / +86-21-6135-6226
E-mail: idecS@cn.idec.com

IDEC (BEIJING) CORPORATION

Room 211B, Tower B, The Grand Pacific Building,
8A Guanghua Road, Chaoyang District,
Beijing 100026, PRC

Tel: +86-10-6581-6131, Fax: +86-10-6581-5119

IDEC (SHENZHEN) CORPORATION

Unit AB-3B2, Tian Xiang Building, Tian'an Cyber Park,
Fu Tian District, Shenzhen, Guang Dong 518040, PRC
Tel: +86-755-8356-2977, Fax: +86-755-8356-2944

IDEC IZUMI (H.K.) CO., LTD.

Unit G & H, 26/F., MG Tower, No. 133 Hoi Bun Road,
Kwun Tong, Kowloon, Hong Kong
Tel: +852-2803-8989, Fax: +852-2565-0171
E-mail: info@hk.idec.com

IDEC TAIWAN CORPORATION

8F-1, No. 79, Hsin Tai Wu Road, Sec. 1,
Hsi-Chih District, 22101 New Taipei City, Taiwan
Tel: +886-2-2698-3929, Fax: +886-2-2698-3931
E-mail: service@tw.idec.com

IDEC IZUMI ASIA PTE. LTD.

No. 31, Tannery Lane #05-01,
HB Centre 2, Singapore 347788
Tel: +65-6746-1155, Fax: +65-6844-5995
E-mail: info@sg.idec.com

IDEC ASIA (THAILAND) CO., LTD.

20th Fl., Sorachai Bldg., No.23/78,
Soi Sukhumvit 63, Sukhumvit Rd.,
Klongton-nua, Wattana, Bangkok 10110
Tel: +662-392-9765, Fax: +662-392-9768
E-mail: sales@th.idec.com