





# SmartAXIS

Hardware Manual

SmartAXIS FT2J/1J

## SAFETY PRECAUTIONS

- Be certain to read this manual carefully before performing installation, wiring, or maintenance and inspection works, or operating the SmartAXIS FT2J/1J (Hereinafter referred to as "SmartAXIS"). If the SmartAXIS is used in a manner not specified by the manufacturer, the protection provided by the equipment may be impaired.
- The SmartAXIS has been manufactured with careful regard to quality. However, if you intend to use this product in applications where failure of this equipment may result in damage to property or injury, ensure that it is used in conjunction with appropriate fail-safe backup equipment.
- Precautionary measure should be taken to avoid unauthorized access from the outside network to the SmartAXIS. Please note that the Company shall not be liable for any loss, damage or other expenses incurred directly or indirectly by unauthorized access, etc.
- In this manual, safety precautions are categorized depending on the severity as Warning or Caution:

 <b>WARNING</b>	Warning notices are used to emphasize that improper operation may cause severe personal injury or death.
 <b>CAUTION</b>	Caution notices are used where inattention might cause personal injury or damage to equipment.

### WARNING

- This product is not designed for use in applications requiring a high degree of reliability and safety, such as applications for medical devices, nuclear power, railroads, aerospace, and automotive devices. This product should not be used for such applications.
- Turn off the power of this product before installation, removal, wiring, maintenance, and inspection of this product. Failure to turn power off may cause electrical shock or fire hazard.
- Special expertise is required to install, wire, configure, and operate this product. Person without such expertise must not use this product.
- This product uses an LCD (liquid crystal display) as a display device. The liquid inside the LCD is harmful to the skin. If the LCD is broken and the liquid attaches to your skin or clothing, wash the liquid off using soap, and consult a doctor immediately.
- An emergency circuit that uses emergency stop switch or an interlocking circuit must be configured outside of this product.
- Do not use touch switches for an emergency circuit or an interlocking circuit. If this product fails, serious injury to operators and equipment damage may be caused.
- If relays or transistors in this product output circuits should fail, outputs may remain at on or off state. For output signals which may cause serious accidents, configure monitor circuits outside this product.
- This product self-diagnostic function may detect internal circuit or program errors, stop programs, and turn outputs off. Configure circuits so that the system containing this product is not jeopardized when outputs turn off.
- In case this product is accidentally dropped or exposed to significant shock, stop using this product, check this product for damage, and confirm that its various functions work safely and correctly.
- Connect SmartAXIS's FG wire to grounding resistance of 100 Ω or less. Otherwise, there is a risk of electric shock or malfunction.
- The screen will not be visible if the backlight of this product burns out. However, the touch panel will remain functional. Thus, erroneous touch panel operation may occur while controlling the touch panel. Because such erroneous operations could result in damage, the touch panel should not be used once the backlight is burned out.

 CAUTION

- Prevent this product from falling while moving or transporting, otherwise it may cause damage or malfunction to this product as a result.
- Use the product within the environmental limits given in the catalog and this manual. Use of the product in high-temperature or high-humidity environments, or in locations where it is exposed to condensation, corrosive gas, or large shock loads can create the risk of electrocution and fire.
- This product is designed for use in pollution degree 2. Use this product in environments of pollution degree 2. (based on the IEC 60664-1 rating)
- Install this product according to the this manual. Improper installation will result in falling, failure, electrical shock, fire hazard, or malfunction of this product.
- Prevent metal fragments or wire chips from dropping inside this product housing. Ingress of such fragments and chips may cause fire hazard, damage, and malfunction.
- Use a power supply of the rated value. Using a wrong power supply may cause fire hazard.
- The main unit uses "PS2" as DC power supply. (based on the IEC/EN 61131 rating)
- Use wire of a proper size to meet the voltage and current requirements.
- When exporting this product to Europe, use an EN 60127 (IEC 60127) approved fuse on the power line outside this product.
- When exporting this product to Europe, use an EU-approved circuit protector.
- Make sure of safety before starting and stopping this product. Incorrect operation of this product may cause mechanical damage or accidents.
- This product cannot be directly connected to the communication lines (including public wireless LAN) of telecommunication carriers (mobile communication companies, fixed-line communication companies, Internet providers, etc.). When connecting this product to the Internet, be sure to connect via a device, such as a router.
- The touch panel of this product is made of glass, and will break if exposed to excessive shock. Take due care when handling it.
- When operating the touch panel in an environment where the ambient operating temperature exceeds 50°C, there is a risk of getting burn injury. So please use heat-resistant gloves, touch pen, and such to prevent burn injury.
- The protective film attached to the display of this product is to protect the product from scratches during transportation. Please remove the protective film before use. If the display is used with protective film, the film may become cloudy and stick to the display depending on the usage environment and may become unremovable.
- Do not push hard or scratch the touch panel and protection sheet with a hard object like hand tool. Touch panel and protection sheet can be easily damaged.
- Do not install this product in areas subjected to strong ultraviolet rays.
- Do not attempt to disassemble, repair or modify this product. This can create the risk of fire or electrocution.
- When disposing of this product, do so as an industrial waste.
- When using this product in a system that requires clock accuracy, set the time regularly.
- Do not switch off the power or pull out the USB flash drive while it is being accessed, as this may result in destruction of the stored data. If the data on the USB flash drive is corrupted, format the USB flash drive.
- Turn off the power supply of this product before connecting or disconnecting USB devices other than USB memory.

## Revision history

September 2023:	First Edition
January 2024:	Second Edition
July 2024:	Third Edition

## Caution

- All rights in this manual belong to IDEC Corporation. It may not be reproduced, reprinted, sold, transferred or rented without our permission.
- The contents of this manual are subject to change without notice.
- Please contact your vendor or IDEC Corporation with any problems regarding the operation of this product.

## Trademarks

WindO/I and SmartAXIS are registered trademarks of IDEC CORPORATION in JAPAN.

All other company names and product names used in this manual are trademarks of their respective owners.

## Regarding Compatible Standards

The conforming standards supported by this product are as follows.

### UL 121201 / CSA C22.2 No.213 (Under application)

- This product is for indoor use only.
- Open type or panel mounted when installed in a Listed Type 4X "Indoor Use Only", Type 13 enclosure.
- The use of an SELV source.
- When wiring this product at the field, use copper conductors only.

Test item particulars	
Type of item	Open Type/enclosed type when panel mounted in appropriate end enclosure
Description of equipment function	Control
Connection to mains supply	N/A connected to SELV source
Overvoltage Category	None
Pollution Degree	2
Environmental Conditions	Extended:
Temperature:	-20 to +55°C, see RATINGS section for detail.
Humidity:	10 to 95%RH (no condensation)
For use in wet locations	NO
Equipment mobility	Panel mounted
Operating Conditions	Continuous

- This product is suitable for use in Class I, Division 2, Groups A, B, C, D or Non-Hazardous locations only.

#### RATINGS:

Input: 24 Vde, SELV, LIM

Type Number	FT2J-7U22*AF-B	FT1J-4F12RAG-*	FT1J-4F14*AG-*
Power Consumption	17W	13W	15W

Maximum Surrounding Air: -20 to +55°C

Enclosure Type 4X Indoor Use only, Type 13

- Temperature Code: T4A
- Equipment to be installed in an environmentally suitable enclosure that requires the use of a tool to access.
- L'appareil FT2J/1J est conçu pour être utilisé uniquement dans des emplacements de classe I, division 2, groupes A, B, C, Dou non dangereux.
- Caracteristiques:

Entree: 24 Vde, Tres basse tension de securite (SELV), LIMITES

Nummer eingeben	FT2J-7U22*AF-B	FT1J-4F12RAG-*	FT1J-4F14*AG-*
Energieverbrauch	17W	13W	15W

Air ambiant maximal: -20 a +55°C

Boitiers de type 4X pour une utilisation interieure, de type 13.

- Code de temperature: T4A
- L'appareil FT2J/1J doit être installé dans un boîtier adapté à l'environnement et uniquement accessible à l'aide d'outils.

## Preface

Thank you for purchasing the SmartAXIS manufactured by IDEC Corporation.

This manual describes the specifications of the SmartAXIS FT2J/1J, how to install it, and various functions.

Read this manual to ensure the correct understanding of the entire functions of this product.

IDEC Corporation makes the latest product manual PDFs available on our website at no additional cost. Please download the latest product manual PDFs from our website.

Read the following materials as necessary for your particular application.

References	Content
SmartAXIS Hardware Manual (This document)	Describes the product specifications, installation and wiring instructions of the FT2J/1J, optional items, and I/O cartridges.
WindO/I-NV4 User's Manual (PDF)	Describes the basic operations of the FT2J/1J, how to create the project necessary for operation, and the various drawings and parts that make up the project.
Ladder Programming Manual (PDF)	Describes basic operations for programming with ladders, monitoring methods on the WindLDR, instruction lists, and details of each instruction.
WindO/I-NV4 External Device Setup Manual (PDF)	Describes the connection procedures and available device addresses for various communication including the Device Link Communication, O/I Link communication, and DM Link communication.

## Symbols Used in this Manual

This manual uses the following symbols to facilitate explanation.

### Symbols



..... Information that requires special attention. Failure to operate the product in accordance with the information provided can lead to serious injury or damage.



..... Information relating to requests or material to reference in the use of a function



..... Useful information relating to a function

**YES**

..... Screen buttons are indicated by bold text or by using the actual graphic icon.

**\*\*\*\***

..... Controls are indicated by bold text.

## Abbreviations, Generic Terms, and Terminology Used in this Manual

Item	Description
FT2J	The name is short for SmartAXIS FT2J-7U22*AF-B.
FT1J	The name is short for SmartAXIS FT1J-4F1**AG-*
FT2J/1J	The format used to refer to FT2J and FT1J.
SmartAXIS	Generic term for integrated display controller FT2J/1J.
External Device	Generic term used to refer to a PLC or micro computer that is connected to and communicates with the main unit.
Device Address	Memory that is capable of storing values in unit of bits or words loaded on the main unit and external device.
WindO/I-NV4	Integrated configuration software application for creating projects of the main unit.
Operating System	Software used to manage and control system software.
System Software	Software that performs basic control and management of the main unit.
Project	Data including image data required for operating the main unit, which is created with WindO/I-NV4.
Internal Device	The generic term for internal device addressing on the main unit such as internal relays, registers, etc.

## Contents

SAFETY PRECAUTIONS .....	Preface-1
Revision history .....	Preface-3
Caution .....	Preface-3
Trademarks.....	Preface-3
Regarding Compatible Standards .....	Preface-4
Preface .....	Preface-5
Symbols Used in this Manual .....	Preface-5
Abbreviations, Generic Terms, and Terminology Used in this Manual .....	Preface-6

### Chapter 1 Main Unit Specifications

1	FT2J .....	1-1
	1.1 Packing Content.....	1-1
	1.2 Type Number.....	1-1
	1.3 Part Names.....	1-2
	1.4 External Interfaces.....	1-3
	1.5 Specifications.....	1-11
	1.6 Dimensions.....	1-14
	1.7 Installation .....	1-15
	1.8 Wiring .....	1-20
	1.9 Maintenance and Inspection .....	1-24
	1.10 Software License Information.....	1-25
2	FT1J .....	1-26
	2.1 Packing Content.....	1-26
	2.2 Type Number.....	1-27
	2.3 Part Names.....	1-28
	2.4 External Interfaces.....	1-29
	2.5 Specifications.....	1-37
	2.6 Dimensions.....	1-40
	2.7 Installation .....	1-41
	2.8 Wiring .....	1-44
	2.9 Maintenance and Inspection .....	1-47
	2.10 Software License Information.....	1-49

### Chapter 2 I/O Cartridge

1	Digital I/O Cartridge.....	2-1
	1.1 Packing Content.....	2-1
	1.2 Type Number.....	2-1
	1.3 Part Names.....	2-1
	1.4 Specifications.....	2-2
	1.5 Dimensions.....	2-5
	1.6 Install and remove .....	2-5
	1.7 Wiring .....	2-6
2	Analog I/O Cartridge .....	2-7
	2.1 Packing Content.....	2-7



2.2	Type Number .....	2-7
2.3	Part Names.....	2-8
2.4	Specifications.....	2-9
2.5	Dimensions.....	2-13
2.6	Install and remove .....	2-13
2.7	Wiring .....	2-14

### Chapter 3 Options

1	Optional items.....	3-1
1.1	FT2J.....	3-1
1.2	FT1J.....	3-2
2	Replacement Parts.....	3-3
2.1	FT2J.....	3-3
2.2	FT1J.....	3-3

### Chapter 4 Module Configuration Editor





1	Overview .....	4-1
1.1	Configuration & Functions.....	4-1
2	Basic Operations.....	4-2
2.1	Open the Module Configuration Editor .....	4-2
2.2	Inserting I/O Cartridges.....	4-2
2.3	Deleting I/O Cartridge .....	4-4
2.4	Changing I/O Cartridge.....	4-5
3	Digital I/O Cartridge Settings.....	4-6
3.1	I/O Assignments .....	4-6
3.2	Parameter Settings.....	4-6
4	Analog I/O Cartridge Settings .....	4-7
4.1	I/O Assignments .....	4-7
4.2	Parameter Settings.....	4-7

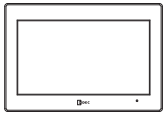
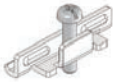
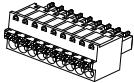

## 1 FT2J

### 1.1 Packing Content

Before installing the main unit, make sure that the model you have received is what you actually ordered, and no parts are damaged to accidents during shipping.

Product Name & Dimensions	Quantity	Description
FT2J 	1	Main unit
Mounting clips 	4	-
Serial interface connector 	1	Removable terminal block 9-pin
Input terminal connector 	1	Removable terminal block 16-pin
Output terminal connector 	1	Removable terminal block 11-pin
Dummy cartridge 	2	Attached to the main unit

### 1.2 Type Number

LCD	Bezel Color	Input Terminal Specification	Output Terminal Specification	Type Number
7.0 inch wide TFT Color	Black	Digital input (shared sink/source): 10 Analog input (shared digital sink input): 4	Relay output: 8	FT2J-7U22RAF-B
			Transistor sink output: 6 Analog output: 2	FT2J-7U22KAF-B
			Transistor source output: 6 Analog output: 2	FT2J-7U22SAF-B

### 1.3 Part Names

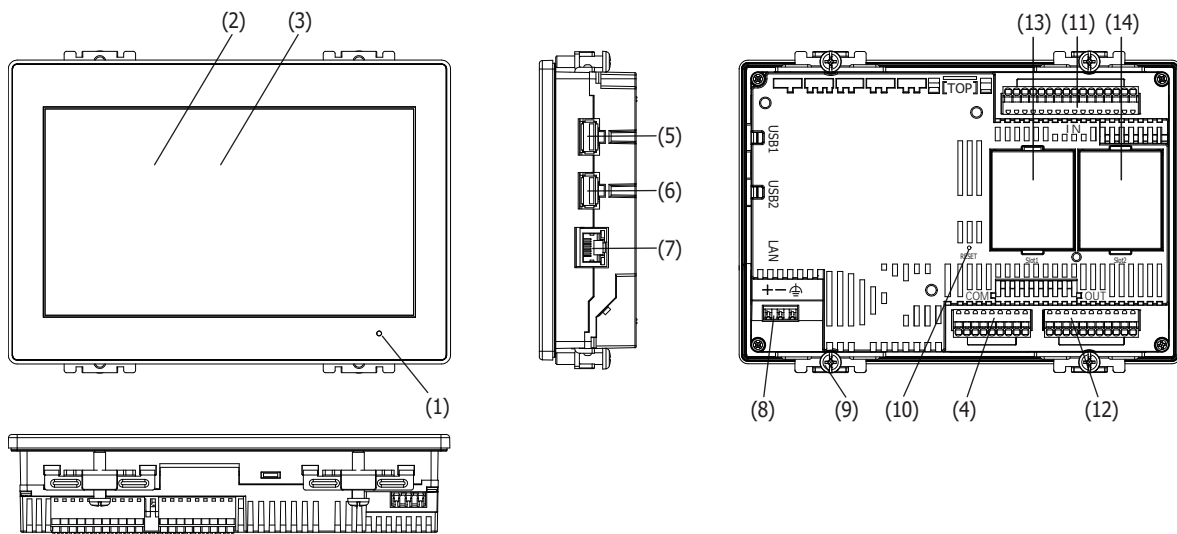

No.	Name	Description
(1)	POWER LED	Green (lit): Normal Operation Green (flash): Operating system is booting. (Normal Operation) Orange (lit): Operating system is booting. (Boot mode) Orange (flash): Preparing to boot the operating system, running in boot mode. Red (lit): Main unit is damaged. Not lit : Power is off.
(2)	Display	TFT color LCD
(3)	Touch Panel	PCAP touchscreen (Projected capacitive)
(4)	Serial Interface (COM)	RS232C, RS422/485 Connector: Terminal Block 9-pin (Push-in type) Maximum cable length: 15m (RS232C), 1200m (RS422/485)
(5)	USB Interface (USB1)	USB2.0 (Host) Connector: Type A Output current: 5V 500 mA
(6)	USB Interface (USB2)	USB2.0 (Host) Connector: Type A Output current: 5V 500 mA
(7)	Ethernet Interface (LAN)	IEEE802.3u 10BASE-T/100BASE-TX Connector: RJ-45 (With Auto MDI/MDI-X function) Maximum cable length: 100m
(8)	Power Supply Terminal	Connector: Terminal Block 3-pin (Push-in type)
(9)	Mounting Clip Position	4 places
(10)	RESET Switch	Tact switch
(11)	Input Terminal (IN)	Connector: Removable terminal block 16-pin (Push-in type) Digital input (shared sink/source) (I0 to I7, I10, I11) Analog input (shared digital sink input) (I12 to I15)
(11)	Output Terminal (OUT)	Connector: Removable terminal block 11-pin (Push-in type) Relay Output (Q0 to Q7) Transistor sink output (Q0 to Q5), Analog output (AQ0, AQ1) Transistor source output (Q0 to Q5), Analog output (AQ0, AQ1)
(13)	Cartridge Slot (Slot1)	Slots for connecting the following I/O cartridges. For details about the cartridges, refer to Chapter 2 "I/O Cartridge" on page 2-1.
(14)	Cartridge Slot (Slot2)	Digital I/O cartridge: FC6A-PN4, FC6A-PTK4, FC6A-PTS4 Analog I/O cartridge: FC6A-PJ2A, FC6A-PJ2CP, FC6A-PK2AV, FC6A-PK2AW

## 1.4 External Interfaces

### ⚠ CAUTION

- Make sure to turn off the power to the FT2J before wiring each interface.
- The serial interface (COM) can be used as the RS232C and RS422/485 interfaces at same time.
- Use the SELV (Safety Extra-Low Voltage) circuit to connect the Serial, USB and Ethernet interfaces.
- Use the SELV (Safety Extra-Low Voltage) circuit and LIM (Limited Energy) when connecting a DC power supply to the Input and Output terminals.

#### ● Serial Interface (COM)

Use applicable cables for wiring and recommended ferrules (made by IDEC, Weidmüller or Phoenix Contact) as follows.

Interface Specification	RS232C, RS422/485		
Connector	Removable terminal block 9-pin		
Applicable cable	AWG16 to 28		
Conductor Type	Solid wire or Stranded wire		
Wire Strip Length *1	8 to 9 mm		
Recommended ferrule	S3TL-H025-12WJ S3TL-H034-12WT S3TL-H05-14WA S3TL-H075-14WW (IDEC)	H0,25/12 HBL H0,34/12 TK H0,5/14 OR H0,75/14 W (Weidmüller)	AI 0,25-8YE AI 0,34-8TQ AI 0,5-8WH AI 0,75-8GY (Phoenix Contact)

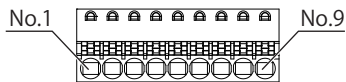

No.	Name	I/O	Function	Communication type	
1	SD	OUT	Send Data	RS232C	/
2	RD	IN	Receive Data		
3	RS	OUT	Request to Send		
4	CS	IN	Clear to Send		
5	SG	—	Signal Ground	RS422/485	/
6	SDA	OUT	Send Data (+)		
7	SDB	OUT	Send Data (-)		
8	RDA	IN	Receive Data (+)		
9	RDB	IN	Receive Data (-)		

\*1 Strip the sheath of the wire 8 to 9 mm from the end.

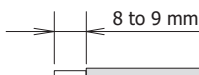

### Using RS422/485 interface

FT2J is not equipped with terminating resistor. Insert a terminating resistor of an appropriate value (about 100 to 120 Ohm, 1/2 W minimum) between terminal number 8 (RDA) and terminal number 9 (RDB), if necessary.

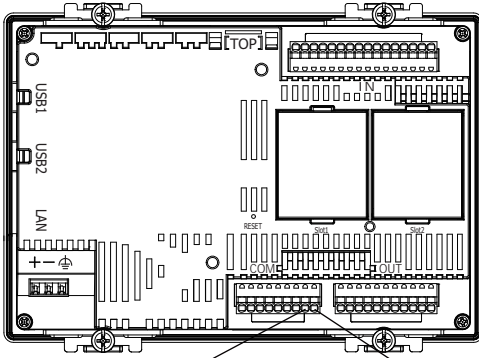

Terminal Number 8 (RDA)    Terminal Number 9 (RDB)

For inserting and removing wires, refer to "1.8 Wiring" on page 1-20.

### ● Input Terminal (IN)

Use applicable cables for wiring and recommended ferrules (made by IDEC, Weidmüller or Phoenix Contact) as follows.

Connector	Removable terminal block 16-pin (Push-in type)		
Applicable cable	AWG16 to 28		
Conductor Type	Solid wire or Stranded wire		
Wire Strip Length*1	8 to 9 mm		
Recommended ferrule	S3TL-H025-12WJ S3TL-H034-12WT S3TL-H05-14WA S3TL-H075-14WW (IDEC)	H0,25/12 HBL H0,34/12 TK H0,5/14 OR H0,75/14 W (Weidmüller)	AI 0,25-8YE AI 0,34-8TQ AI 0,5-8WH AI 0,75-8GY (Phoenix Contact)
Input Points	14		
Rated Input Voltage	24V DC		
Input Voltage Range	0 to 28.8V DC		
Effect of Improper Input Connection	No damage However, if high voltage is applied that exceeds the operating input voltage range, there is a risk of permanent damage.		

\*1 Strip the sheath of the wire 8 to 9 mm from the end.

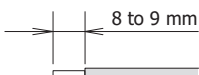

Digital Input

Input Circuit Type		Shared sink/source	
Input Points (Terminal Number/Common Line Name)		10 points in 1 common line (I0 to I7, I10, I11 / COM0 terminal)	
Rated Input Current	I0 to I5	4 mA/point (at 24V DC)	
	I6, I7, I10, I11	5 mA/point (at 24V DC)	
Input Impedance	I0 to I5	5.6 k $\Omega$	
	I6, I7, I10, I11	4.3 k $\Omega$	
Input Delay Time	Turn ON Time	I0 to I5	25 $\mu$ s maximum + software filter setting
		I6, I7, I10, I11	100 $\mu$ s maximum + software filter setting
	Turn OFF Time	I0 to I5	25 $\mu$ s maximum + software filter setting
		I6, I7, I10, I11	100 $\mu$ s maximum + software filter setting
Isolation	Between Input Terminal and Internal Circuit	Photocoupler isolated	
	Between Input Terminals	Not isolated	
Input Type		Type1 (IEC 61131-2)	
External Load for I/O Interconnection		Not isolated	
Signal Determination Method		Static	
Effect of Improper Input Connection		Even if wiring for sink or source connection is incorrect, no damages are caused. However, if high voltage is applied that exceeds the operating input voltage range, there is a risk of permanent damage.	
Cable Length in compliance with electromagnetic immunity		3 m	

## ■ Operating Ranges

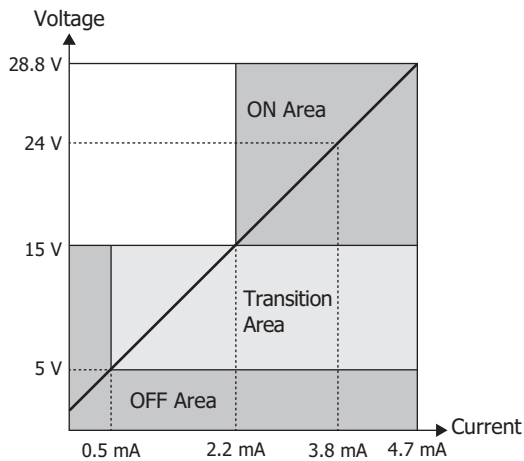
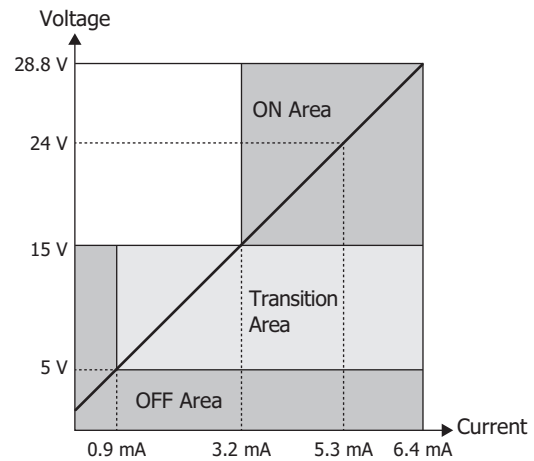
**I0 to I5****I6, I7, I10, I11**

## ■ Input Equivalent Circuit

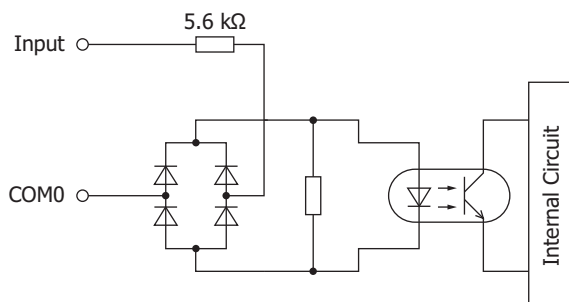
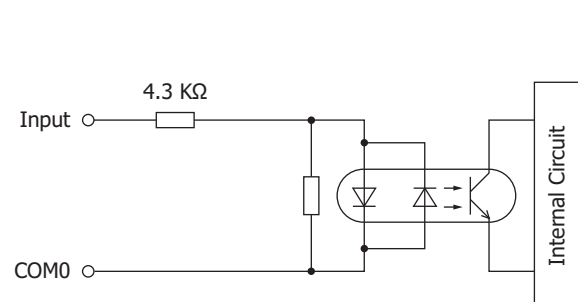
**I0 to I5****I6, I7, I10, I11**

Analog Input (shared digital sink input)

Input Electrical Characteristic* <sup>1</sup>		Voltage	Current
Input Points (Terminal Number/Common Line Name)		4 points in 1 common line (I12 to I15/ COM1(-) terminal)	
Input Range		0 to 10V DC	4 to 20 mA
Input Impedance		78kΩ	250kΩ
Digital Resolution		4096 (12 bit)	
Data Type		Can be set for each channel. Binary data: 0 to 4095 Optional range* <sup>2</sup> : -32768 to 32767	
AD Conversion	Sampling time	5 msec max.	
	Sample Repetition Time	5 msec max.	
	Total Input Delay Time	6 msec + 1 scan time	
	Type of Input	Single-ended	
	Operation Mode	Self-scan	
	Conversion Method	SAR	
Input Error	Maximum Error at 25°C	±3.0% of full scale	
	Temperature Coefficient	±0.04% of full scale/°C	
	Maximum Error	±5.0% of full scale	
Status Display		Device Monitor screen (LCD display)	
Noise Resistance	Maximum Temporary Deviation during Electrical Noise Tests	±5.0% of full scale	
	Input Filter	Yes	
	Recommended Cable for Noise Immunity	Shielded cable	
Calibration to Maintain Rated Accuracy		Not possible	
Maximum Permanent Allowed Overload (No Damage)		28.8V DC	
Overload Status (Outside Input Range) Detection		Detectable	
Isolation	Between Input Terminal and Internal Circuit	Not isolated	
	Between Input Terminals	Not isolated	
Used as Digital Input	Digital Input Type	— (IEC 61131-2 digital input type is not supported)	
	Input Threshold	ON voltage: 15V min.	ON current: 0.20 mA min.
		OFF voltage: 5V max.	OFF current: 0.06 mA max.

\*1 Can be set by application software.

\*2 This function is used the analog value converting it to the specified range.



■ Operating Ranges

I12 to I15

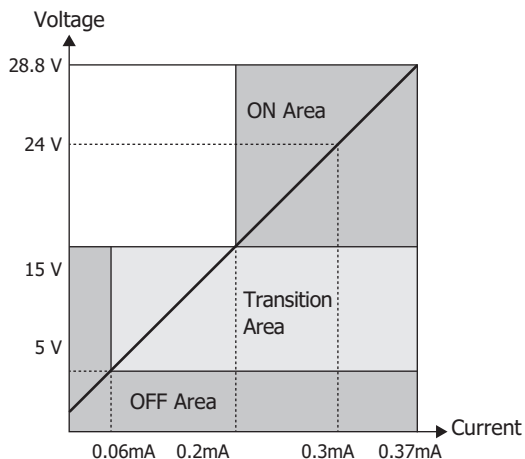

■ Input Equivalent Circuit

I12 to I15

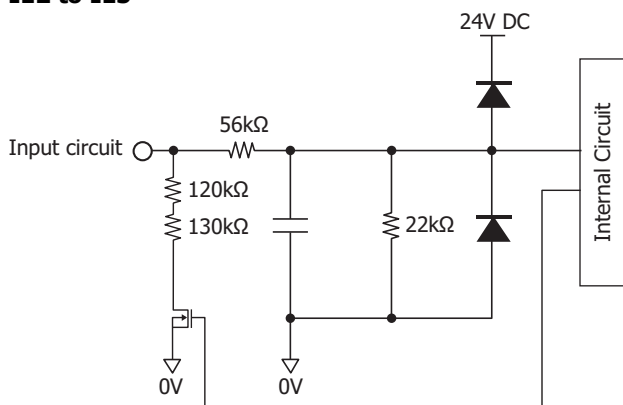

Pulse Input

The maximum input frequency varies based on the input terminal and function.

Input Terminal		I0	I1	I2	I3	I4	I5	
Function*1	High-speed counter	Adding counter	20 kHz	-	20 kHz	20 kHz	20 kHz	20 kHz
		Up/down selection reversible counter	20 kHz	-	-	-	-	-
		Dual-pulse reversible counter	20 kHz	20 kHz	-	-	-	-
		2-edge count	10 kHz	10 kHz	-	-	-	-
		4-edge count	5 kHz	5 kHz	-	-	-	-
	Catch input	20 kHz	-	20 kHz	20 kHz	20 kHz	20 kHz	
	Interrupt input	20 kHz	-	20 kHz	20 kHz	20 kHz	20 kHz	
Frequency measurement	-	-	20 kHz	20 kHz	20 kHz	-		

\*1 Can be set by application software.

## ● Output Terminal (OUT)

Use applicable cables for wiring and recommended ferrules (made by IDEC, Weidmüller or Phoenix Contact) as follows.

Connector	Removable terminal block 11-pin (Push-in type)		
Applicable cable	AWG16 to 28		
Conductor Type	Solid wire or Stranded wire		
Wire Strip Length*1	8 to 9 mm		
Recommended ferrule	S3TL-H025-12WJ S3TL-H034-12WT S3TL-H05-14WA S3TL-H075-14WW (IDEC)	H0,25/12 HBL H0,34/12 TK H0,5/14 OR H0,75/14 W (Weidmüller)	AI 0,25-8YE AI 0,34-8TQ AI 0,5-8WH AI 0,75-8GY (Phoenix Contact)

## Relay Output

Type Number	FT2J-7U22RAF-B	
Output Points (Terminal Number)	8 (Q0 to Q7)	
Output Type	1a contact	
Maximum Load Current	1	2 A max.
	1 common line	7 A max.
Minimum Switching Load	1 mA, 5V DC (reference value)	
Initial Contact Resistance	30 mΩ max.	
Electrical Life	100,000 operations min. (rated resistive load 1,800 operations/hour)	
Mechanical Life	20,000,000 operations min. (no load 18,000 operations/hour)	
Rated Load	240V AC 2 A, 30V DC 2 A	
Withstand Voltage	Between Output Terminal and Internal Circuit	2,300V AC 5 mA, 1 minute
	Between Output Terminals (COM2 and COM3)	
Status Display	Device Monitor screen (LCD display)	



When the output voltage of FT2J-7U22RAF-B exceeds 200V AC, please connect COM2 and COM3 to single power source.

## Output Delay

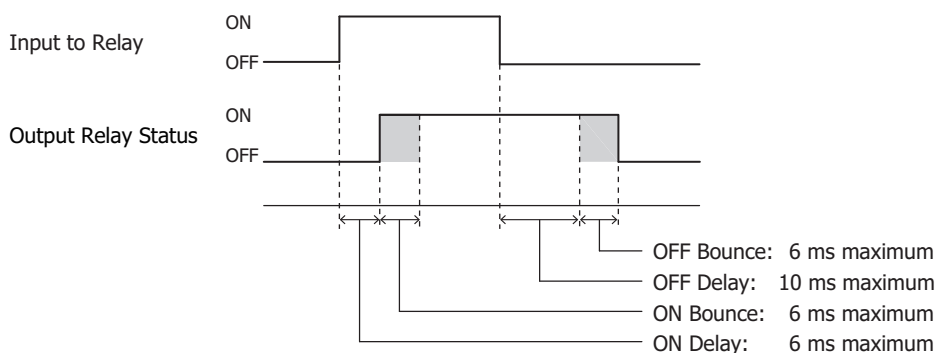

\*1 Strip the sheath of the wire 8 to 9 mm from the end.

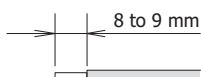

Transistor Output

Type Number	FT2J-7U22KAF-B	FT2J-7U22SAF-B
Output Circuit Type	Sink output	Source output
Output Points	6 (Q0 to Q5)	
Rated Load Voltage	24V DC	
Operating Input Voltage Range	20.4 to 28.8 DC	
Maximum Load Current	1	0.5 A
	1 common line	3 A
Voltage Drop (ON Voltage)	1V max. (Voltage between COM and output terminal when ON)	
Maximum Inrush Current	1 A max.	
Leakage Current	0.1 mA max.	
Inductive Load	L/R=10 ms (28.8V DC, 1 Hz)	
	100 mA max., 24V DC	
External Current Draw	V(+) terminal supply power	COM2(+) terminal supply power
Isolation	Photocoupler isolated	
Status Display	Device Monitor screen (LCD display)	

## ■ Output Equivalent Circuit

## FT2J-7U22KAF-B

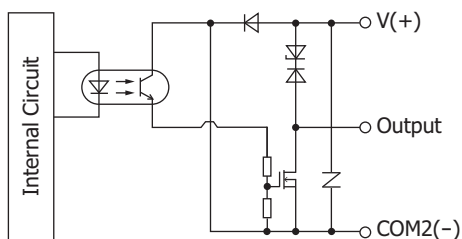

## FT2J-7U22SAF-B

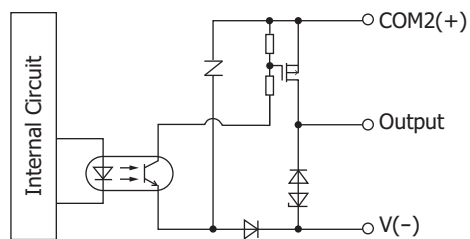

Analog Output

Type Number		FT2J-7U22KAF-B, FT2J-7U22SAF-B	
Output Electrical Characteristic*1		Voltage	Current
Output Points (Terminal Number/Common Line Name)		2 / 1 common line (AQ0, AQ1 / COM3(-) terminal)	
Output Range		0 to 10V DC	4 to 20 mA DC
Output Load	Impedance	2 k $\Omega$ or higher	500 $\Omega$ or lower
	Load Type	Resistive load	
DA Conversion	Scan Time	1 scan	
	Settling time	1 ms or lower	
	Total Output System Transfer Time	1 ms + 1 scan time	
Output Error	Maximum Error at 25°C	$\pm 0.3\%$ of full scale	
	Temperature Coefficient	$\pm 0.02\%$ of full scale/°C	
	Reproducibility after Stabilization Time	$\pm 0.4\%$ of full scale	
	Non-linearity	$\pm 0.01\%$ of full scale	
	Output Ripple	30 mV maximum	
	Overshoot	0%*2	
	Maximum Error	$\pm 1.0\%$ of full scale	
Data	Digital Resolution	4,096 (12 bits)	
	Data Type	Can be set for each channel. Binary data: 0 to 4095 Optional range*3: -32768 to 32767	
	Monotonicity	Yes	
	Current Loop Open	Not detectable	
Noise Resistance	Maximum Temporary Deviation during Electrical Noise Tests	$\pm 5.0\%$ or less of full scale	
	Recommended Cable for Noise Immunity	Shielded cable	
Effect of Improper Output Connection		No damage	
Calibration to Maintain Rated Accuracy		Not possible	

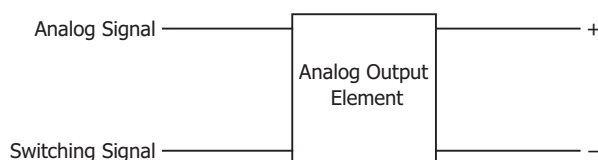
■ **Output Equivalent Circuit**Pulse Output

Type Number	FT2J-7U22KAF-B	FT2J-7U22SAF-B
Output Points	4 (Q0 to Q3)	
Maximum output pulse frequency	20kHz	
PWM output	Duty cycle: 0.1 to 100.0 (increments of 0.1%) Output pulse frequency: 30 to 1000 (increments of 1Hz) When the pulse OFF time is shorter than 25 $\mu$ s, the pulse ON ratio is adjusted so that the OFF time is 25 $\mu$ s and output the signal. When the pulse ON time is shorter than 25 $\mu$ s, the pulse OFF ratio is adjusted so that the ON time is 25 $\mu$ s and output the signal.	

\*1 Can be set by application software.

\*2 Overshoot may occur at light loads. The occurrence of overshoot can be controlled by inserting damping resistance into the circuit. A general guide for the damping resistance value is about 150  $\Omega$  including the input line impedance for the destination.

\*3 This function is used the analog value converting it to the specified range.

## 1.5 Specifications

### ■ Applicable Standards

Safety Standards	UL61010-1, UL61010-2-201, CSA C22.2 No.61010-2-201 (c-UL), UL121201, CSA C22.2 No.61010-1-12 (c-UL), CSA C22.2 No.213 (c-UL)
EMC Standards	IEC/EN 61131-2

### ■ Environmental Specifications

Ambient Operating Temperature	-20 to +55°C*1 (no freezing)
Ambient Operating Humidity	10 to 95% RH (no condensation)
Ambient Storage Temperature	-20 to +70°C (no freezing)
Ambient Storage Humidity	10 to 95% RH (no condensation)
Altitude	0 to 2,000 m (1,013 to 795hPa) during operation 0 to 3,000 m (1,013 to 701hPa) during transport
Pollution Degree	2
Corrosion Immunity	Free from corrosive gases

### ■ Electrical Specifications

Rated Voltage	24V DC				
Power Consumption	17W maximum				
<table border="1" style="width: 100%;"> <tr> <td style="width: 80%;">Not using the USB1 and USB2 interfaces, the IN and OUT terminals, and the Slot1 and Slot2 slots.</td> <td>5W maximum</td> </tr> <tr> <td>When Backlight OFF</td> <td>3W maximum</td> </tr> </table>	Not using the USB1 and USB2 interfaces, the IN and OUT terminals, and the Slot1 and Slot2 slots.	5W maximum	When Backlight OFF	3W maximum	
Not using the USB1 and USB2 interfaces, the IN and OUT terminals, and the Slot1 and Slot2 slots.	5W maximum				
When Backlight OFF	3W maximum				
Power Voltage Range	20.4 to 28.8V DC				
Allowable Momentary Power Interruption	10 ms maximum (Power supply voltage: 24.0V DC to 28.8V DC) 5 ms maximum (Power supply voltage: 20.4V DC to 24.0V DC)				
Inrush Current	40 A maximum				
Dielectric Withstand Voltage	500V AC, 5 mA, 1 minute (between power and earth terminals) 500 V AC, 5 mA, 1 minute (between input and earth terminals) 2300 V AC, 5 mA, 1 minute (between relay output and earth terminals) 500 V AC, 5 mA, 1 minute (between transistor output and earth terminals) 500 V AC, 5 mA, 1 minute (between power and input terminals) 500 V AC, 5 mA, 1 minute (between power and transistor output terminals) 2300 V AC, 5 mA, 1 minute (between power and relay output terminals) 500 V AC, 5 mA, 1 minute (between input and transistor output terminals) 2300 V AC, 5 mA, 1 minute (between input and relay output terminals)				

### ■ Construction Specifications

Type Number	FT2J-7U22RAF-B	FT2J-7U22KAF-B, FT2J-7U22SAF-B
Vibration Resistance	5 to 8.4Hz amplitude 3.5mm, 8.4 to 150Hz acceleration 9.8m/s <sup>2</sup> 10 times on each of three mutually perpendicular axes (IEC 61131-2)	
Shock Resistance	98m/s <sup>2</sup> , 11ms (3 shocks on each of three mutually perpendicular axes) (IEC 61131-2)	147m/s <sup>2</sup> , 11ms (3 shocks on each of three mutually perpendicular axes) (IEC 61131-2)

\*1 For details about the restrictions due to the ambient operating temperature, refer to "Restrictions due to mounting orientation" on page 1-17.

## ■ Function Specifications

Display	LCD Type <sup>*2</sup>	TFT color LCD
	Display Colors	65,536
	Effective Display Area	154.08 (W) × 85.92 (H) mm
	Display Resolution	800 (W) × 480 (H) dots
	Dot pitch	0.1926 (W) × 0.179 (H) mm
	View angle	Left/Right/Top: 80°, Bottom: 60°
	Brightness of LCD only	500 cd/m <sup>2</sup>
	Brightness Adjustment	48 levels
	Backlight	LED (white)
	Backlight Life <sup>*3</sup>	Approx. 50,000 hours (The time until brightness becomes 50% of the initial value)
Touch Panel	Switch Type	Projected Capacitive
	Multiple Operations	Possible (2-point touch)
User Memory		Approx. 24 MB
Backup time of the real-time clock (Ambient Operating Temperature at 25°C)		Min. 20 days <sup>*5</sup>
Backup Data	Keep by a large-capacity capacitor	Clock Data
	Save to non-volatile memory	Log data, HMI Keep Relays, HMI Keep Registers, Internal Relays, Shift Registers, Counters, Data Registers
Buzzer output		Single tone (tone length is adjustable)
Degree of Protection <sup>*4</sup>		Panel thickness is 1mm or more and less than 1.6mm: IP65F (IEC 60529) Panel thickness is 1.6mm or more and 5mm or less: IP66F, IP67F (IEC 60529), TYPE 4X (indoor use only), TYPE 13
Weight (approx.)		600g

\*2 Please be aware that small black and bright dots might show up on LCD Screen: it is not a failure or malfunction.

\*3 The life of the LCD itself at an ambient operating temperature of 25°C. This is not a guaranteed value. The actual life depends on the environment and conditions of use.

\*4 It is a protection structure for the operating surface of HMI, which is attached to a panel. Although protection structure suffices every test conditions, it does not guarantee to operate under all of the environmental condition. As for IP65F/IP66F/IP67F oilproof structure, it suffices oilproof test conditions. Conditions are listed in the document that comes with Japanese Industrial Standard JIS C 0920.

Protection structure do not gurantee usage under long exposure to oil or usage of oil that is not prescribed in the document. Please test/check beforehand to avoid trouble.

IP ratings are not applicable to UL certification.

\*5 If the power interruption period exceeds the Backup time of the real-time clock, the error message "Initialize clock data" will be displayed when the power is turned on, and the clock data will be initialized to 00:00:00 on January 1, 2000.

## ■ EMC Specifications

Radiated Emission	Class A: 10m 40dB $\mu$ V/m quasi-peak (30M to 230MHz) 47dB $\mu$ V/m quasi-peak (230M to 1GHz) Class A: 3m 76dB $\mu$ V/m (Peak), 56dB $\mu$ V/m (AVG) (1G to 3GHz) 80dB $\mu$ V/m (Peak), 60dB $\mu$ V/m (AVG) (3G to 6GHz)
Electrostatic Discharge	Contact: $\pm$ 6kV Air: $\pm$ 8kV
Electromagnetic Field	10V/m (80M to 1000MHz) 3V/m (1.4G to 2.0GHz) 3V/m (2.0G to 2.7GHz) 3V/m (2.7G to 6.0GHz) 80% AM (1kHz)
Fast Transient Burst	Power: $\pm$ 2kV Communication cable: $\pm$ 1kV
Surge Immunity	$\pm$ 500V (between +24V and 0V) $\pm$ 500V (between +24V and FE, 0 and FE)
Conducted Radio Frequency Immunity	10V (Power, Communication cable) (150k to 80MHz) 80% AM (1kHz)

## 1.6 Dimensions

Unit: mm

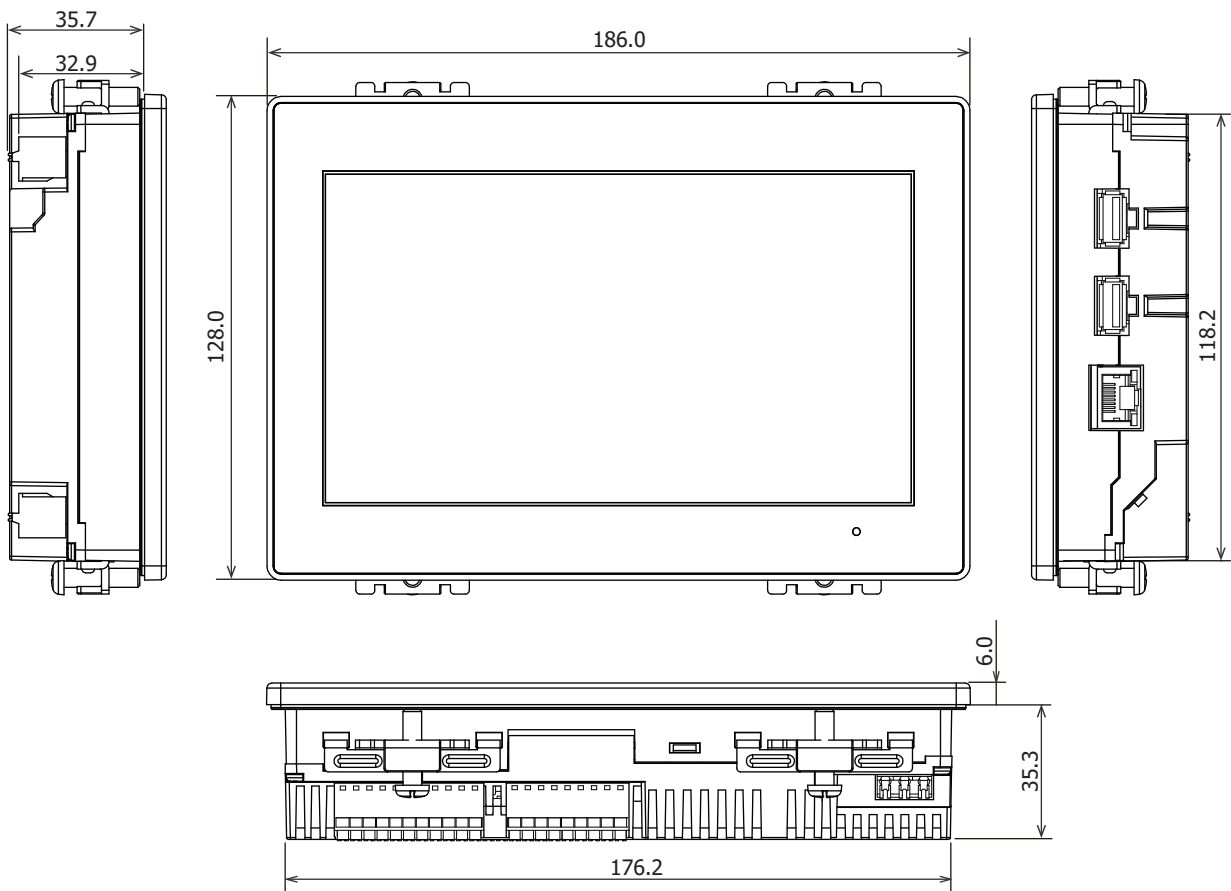

### <Cable Attached Dimensions>

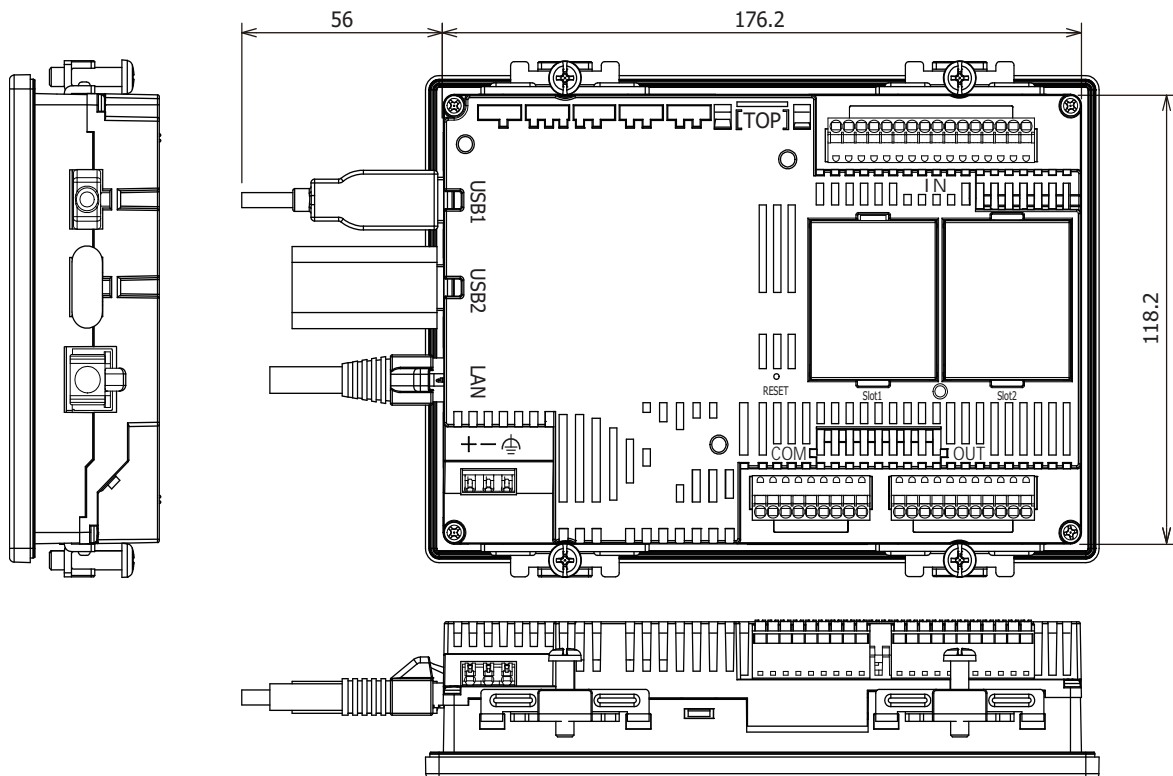

Depending on the type of connection cable used the dimensions shown above will change. The dimensions given here are representative values and are intended for reference only.



### ● About the printed contents of the main unit

"Mark A" indicates that you can refer to the instruction sheet by using the QR code. For details about Conductor material and wire size, refer to "1.4 External Interfaces" on page 1-3 and "1.8 Wiring" on page 1-20.

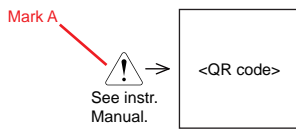

## 1.7 Installation

### ● Operating Environment

For designed performance and safety of the FT2J, do not install the FT2J in the following environments:

- Where dust, briny air, or iron powder exist.
- Where oil or chemical splashes for a long time.
- Where space is filled with oil mist.
- Where direct sunlight falls on the FT2J.
- Where strong ultraviolet rays fall on the FT2J.
- Where corrosive or combustible gasses exist.
- Where shocks or vibrations are transmitted.
- Where condensation occurs due to rapid temperature change.
- Where high-voltage or arc-generating equipment (electromagnetic contactors or circuit protectors) exists in close proximity.

### ● Ambient Temperature

- Allow sufficient space for ventilation, and install the equipment away from heat sources.
- Allow at least 100mm between the FT2J and walls or other equipment.
- Do not install the FT2J where the ambient temperature exceeds the rated ambient operating temperature range. When mounting the FT2J in such locations, provide a forced air-cooling fan or air-conditioner to keep the ambient temperature within the rated temperature range.
- The FT2J is designed to install on a vertical plane so that natural air-cooling is provided. If you install it using any other orientation, use forced-air cooling, or lower the ambient operating temperature.

### ● About Derating

The FT2J suppresses the temperature rise inside the product by reducing the backlight brightness when the ambient operating temperature becomes high.

The relationship between the ambient operating temperature and brightness is as follows.

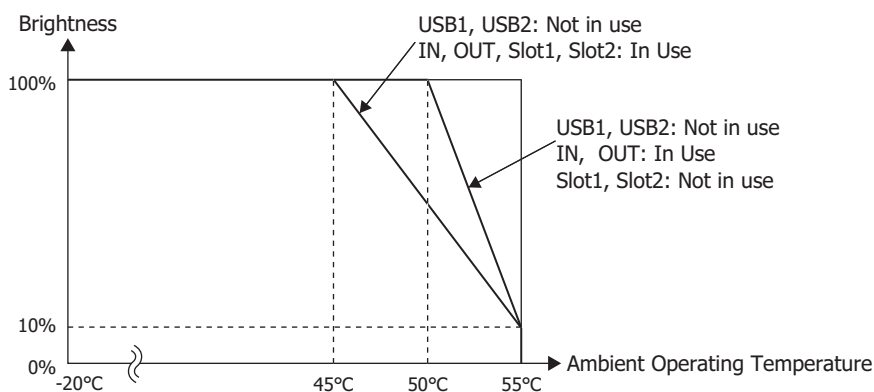

Brightness reduction occurs depending on the usage of the USB interface, IN, OUT, and cartridge slots.

Depending on each product the values shown above will change. The values given here are representative values intended for reference only.

## ● Installation

- Make a panel cut-out on the panel with the dimensions shown below.

Unit: mm

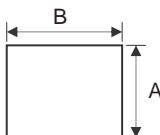

A		B		Panel Thickness
118.6	$+1.0$ 0	176.6	$+1.0$ 0	1.0 to 5.0

- Use the attached mounting clips to tighten the screws evenly to mount panel: screws must be applied on total of four places with the specified torque 0.5 to 0.6N·m.

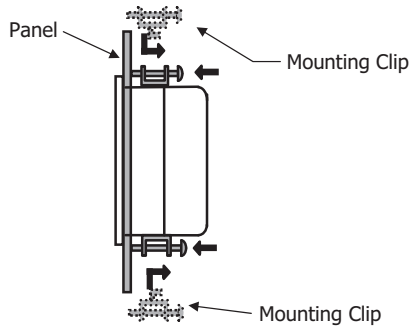

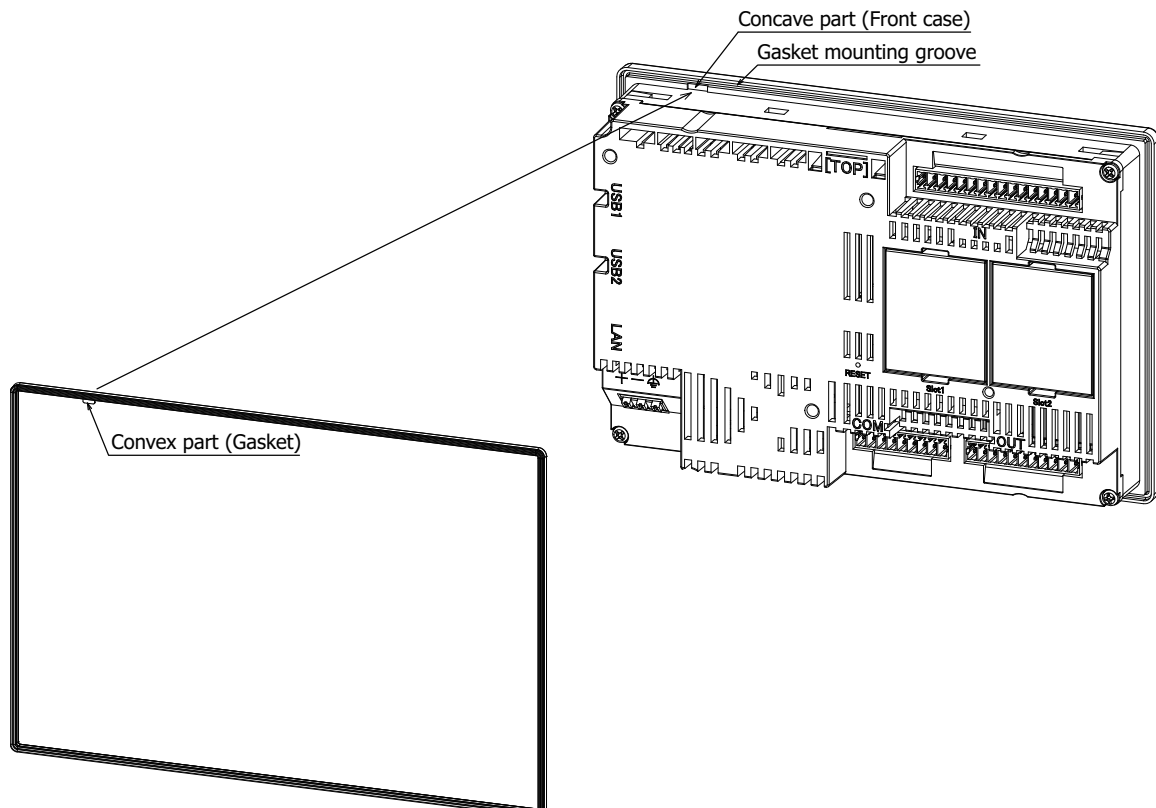

## ⚠ CAUTION

- Mount the main unit on a rigid panel.
- Do not tighten with excessive force, otherwise the main unit may warp the display, or impair the waterproof characteristics.
- If the mounting clips are tightened obliquely to the panel, the main unit may fall off the panel.
- When installing the main unit into a panel cut-out, make sure that the gasket is not twisted. Especially when re-installing, take special care because any twists in the gasket will impair the waterproof characteristics. Also, if the gasket comes off the main unit, align the convex part of the gasket with the concave part of the front case, and then insert the gasket fully into the gasket mounting groove without twisting it.



● Restrictions due to mounting orientation

The FT2J is designed to install on a vertical landscape. The ambient operating temperature and the output current of the USB interface (total of USB1 and USB2) are limited as shown in the table below.

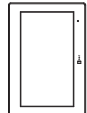
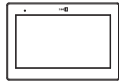
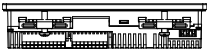
Orientation		Ambient Operating Temperature: Output current limitation of USB interface
Vertical	 Landscape	-20 to +45°C: 1000 mA +45 to +50°C: 500 mA +50 to +55°C: 150 mA
	 Portrait (Clockwise)	-20 to +40°C: 1000 mA +40 to +55°C: 150 mA
	 Portrait (Counter Clockwise)	
	 Landscape (Rotate 180°)	-20 to +50°C: 500 mA +50 to +55°C: 150 mA
 Horizontal		



- When installing the FT2J in a diagonal, the limitations are same as a horizontal.
- Confirm the visibility of the display in a final installation.
- When mounting in Landscape (Rotate 180 degrees) or Horizontal orientation, it is not possible to use the USB interface with an output current that exceeds 500mA.
- Cartridge slots (Slot1, Slot2) cannot be used in the following cases.
  - Orientation is in Vertical - Portrait (Clockwise) or - Portrait (Counter Clockwise) and the ambient operating temperature is +50 to +55°C.
  - Orientation is in Horizontal and the ambient operating temperature is +45 to +55°C.
- The analog I/O cartridge FC6A-PK2AW cannot be used when the orientation is in Horizontal and the ambient operating temperature is +40 to +45°C.

For details about how to install the cartridge, refer to Chapter 2 "1.6 Install and remove" on page 2-5 or Chapter 2 "2.6 Install and remove" on page 2-13.

By reducing the input voltage and input utilization (simultaneous ON ratio: a%) of I0 to I7, I10 and I11, use within the ambient operating temperature range appropriate for the mounting orientation.

Type No.	FT2J-7U22RAF-B	FT2J-7U22KAF-B, FT2J-7U22SAF-B
Landscape		
Portrait (Clockwise)		
Portrait (Counter Clockwise)		
Landscape (Rotate 180°)		
Horizontal		

If in compliance with UL standards, please follow the diagram below to reduce the input voltage and input usage rate (ON state ratio: a%) accordingly.

Type No.	FT2J-7U22RAF-B	FT2J-7U22KAF-B, FT2J-7U22SAF-B
Landscape		
Portrait (Clockwise)		
Portrait (Counter Clockwise)		
Landscape (Rotate 180°)		
Horizontal		

## 1.8 Wiring

### ⚠ CAUTION

- Turn off the power supply before wiring.
- Make the wiring as short as possible and run all wires as far away as possible from high-voltage and large-current cables. Follow all the procedures and precautions when wiring the FT2J.
- Separate the FT2J power supply wiring from the power lines of I/O devices and motor equipment.
- Ground the functional earth terminal to make sure of correct operation.
- Use the SELV (Safety Extra-Low Voltage) circuit and LIM (Limited Energy) circuit for power supply.
- Use Copper Conductors Only.

### ● Terminal Arrangement and Wiring Examples

#### FT2J-7U22RAF-B

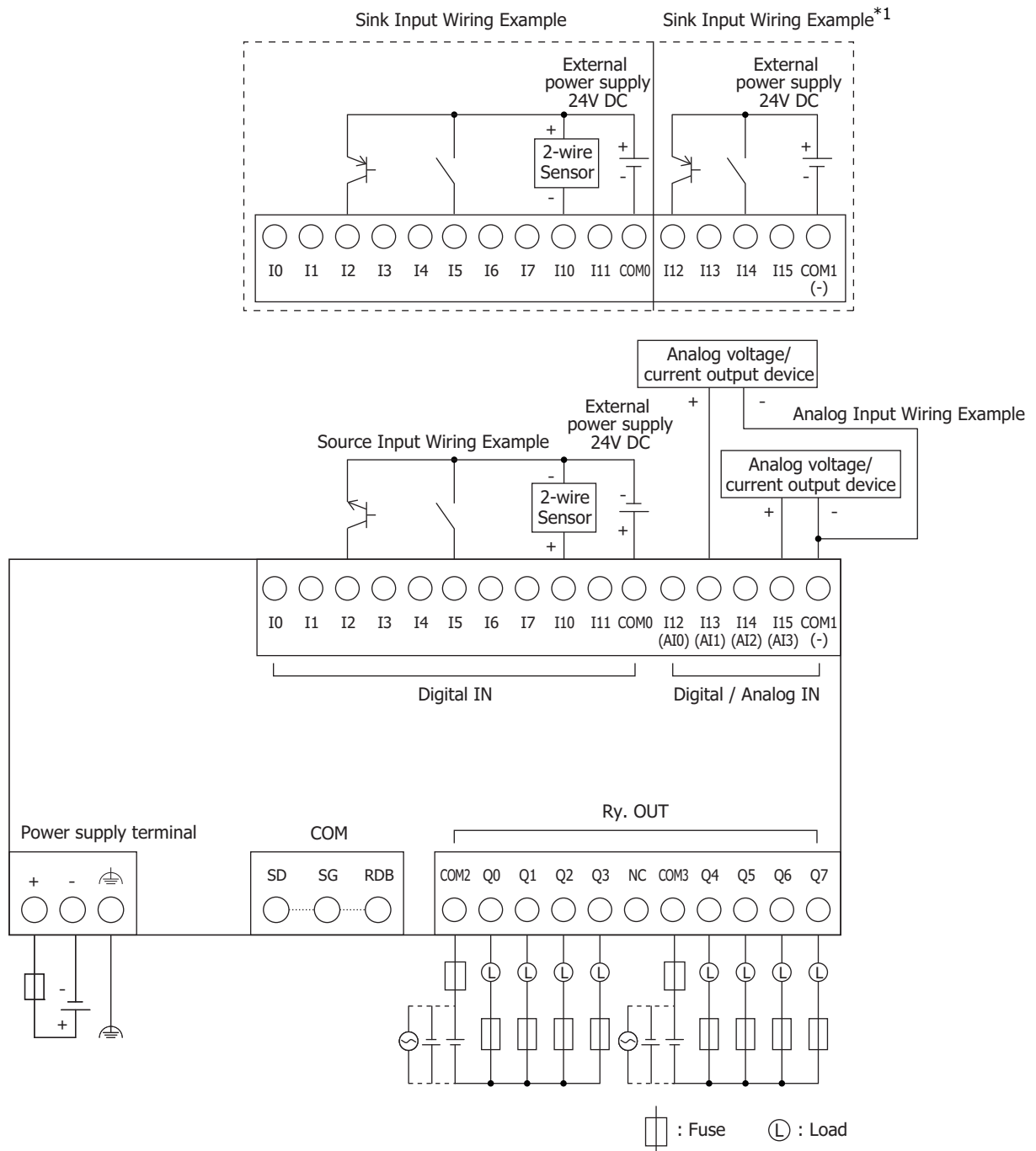

\*1 I12 to I15 cannot be used as source inputs.

FT2J-7U22KAF-B

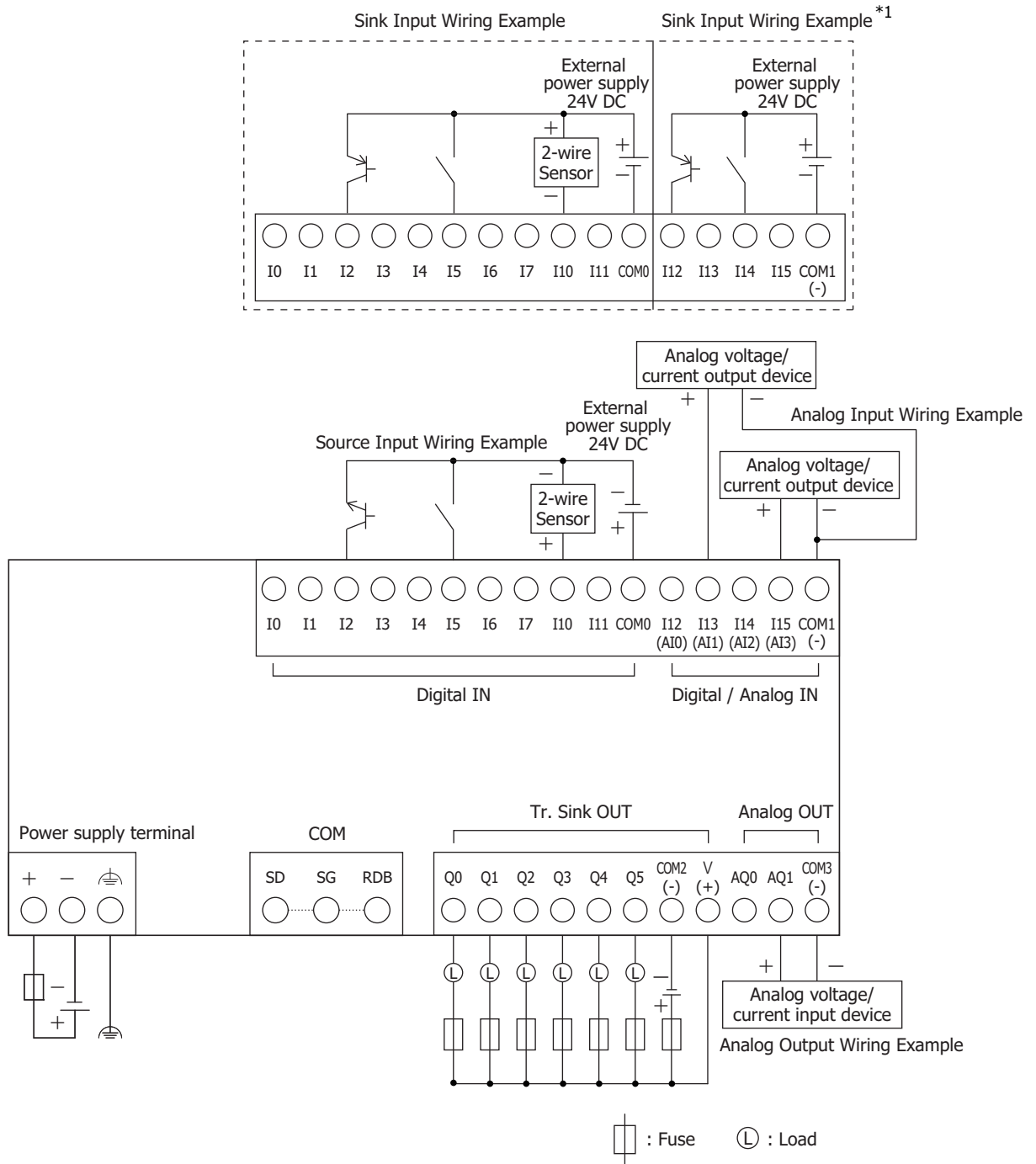

\*1 I12 to I15 cannot be used as source inputs.

**FT2J-7U22SAF-B**

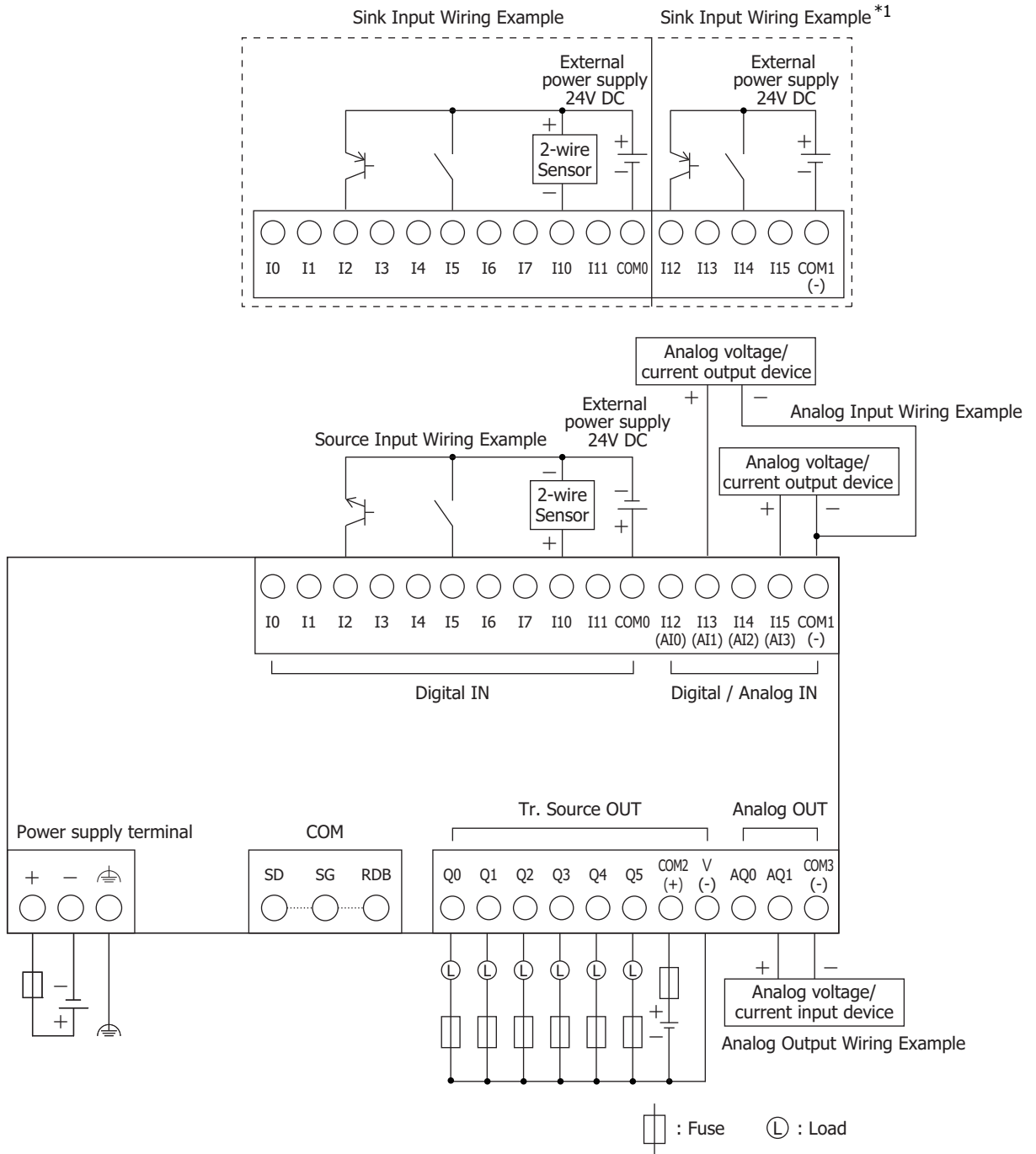

\*1 I12 to I15 cannot be used as source inputs.



### ● Power Supply Terminal

- Pin assignment is shown in the following table.

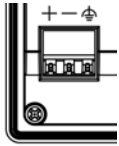

+	Power supply (24V DC)
-	Power supply (0V)
	Functional Earth (FE)

- Use applicable cables for wiring and recommended ferrules (made by IDEC, Weidmüller or Phoenix Contact) as follows.

Applicable cable	AWG14 to 28		
Conductor Type	Solid wire or Stranded wire		
Wire Strip Length*1	7 to 9 mm		
Recommended ferrule	S3TL-H025-12WJ S3TL-H034-12WT S3TL-H05-14WA S3TL-H075-14WW (IDEC)	H0,25/12 HBL H0,34/12 TK H0,5/14 OR H0,75/14 W (Weidmüller)	AI 0,25-8YE AI 0,34-8TQ AI 0,5-8WH AI 0,75-8GY (Phoenix Contact)

### ● Caution when inserting and removing wires

- When connecting a wire that has not been treated with a tip, such as a stranded wire, you can connect it by inserting the wire all the way in while pressing the pusher, and then releasing the pusher.
- When connecting wires with ferrules, connect the ferrules to the terminal block so that the long side is horizontal. (See the figure below.)

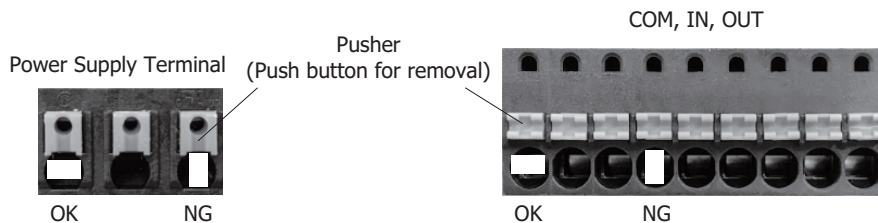

- Do not pull out the wire without pressing the pusher. When pulling out the wire, use a flat blade screwdriver, etc., and pull the wire straight out while pressing the pusher with about 20 N of force.
- Be careful not to damage the push-in terminals. When pressing the pusher, do not apply more than 40N of force.

### ● Cautions for using the FT2J connected to a personal computer

When connecting the FT2J to a personal computer via the USB Interfaces, the FT2J or the personal computer may break down depending on the conditions of the personal computer. Make sure of the following cautions, in order to prevent an accident.

- If the personal computer has a 3-pin power plug or power plug with a ground lead type, make sure to use a plug socket including a ground input electrode or ground the earth lead, respectively.
- If the personal computer has a 2-pin power plug without ground lead, follow the procedure below when connect the FT2J to the personal computer.
  - (1) Pull out the power plug of the personal computer from the AC outlet.
  - (2) Connect the FT2J to the personal computer.
  - (3) Insert the power plug of the personal computer into the AC outlet.

\*1 Strip the sheath of the wire 7 to 9 mm from the end.

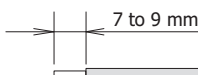

## ● Recommended Tools

Tool Name		Model Number (Order Number)	Manufacturer
Flat blade screwdriver	Normal type	SDS 0.4×2.5×75 (9009030000)	Weidmüller
	With insulated cover	S3TL-D04-25-75	IDEC
		SDIS 0.4×2.5×75 (9008370000)	Weidmüller
Crimping tool		S3TL-CR06D	IDEC
		PZ6/5 (9011460000)	Weidmüller
Stripping tool		S3TL-ST06	IDEC
		STRIPAX(9005000000)	Weidmüller

## 1.9 Maintenance and Inspection

Maintain and inspect the FT2J periodically to ensure the best performance. Do not disassemble, repair, or modify the FT2J during inspection.

Maintenance and Inspection Parts	Description
Display	Wipe any stain of the display using a soft cloth slightly dampened with neutral detergent or alcoholic solvent. Do not use solvents such as thinner, ammonia, strong acid, and strong alkaline.
Terminals, Connectors	Check the terminals and connectors to make sure of no loose screws, incomplete insertion, or disconnected lines.
Mounting Clips	Make sure that all mounting clips and screws are tightened sufficiently. If the mounting clips are loose, tighten the screw to the specified torque.
Backlight	The FT2J's backlight cannot be replaced by the customer. When the backlight needs to be replaced. Contact your vendor or IDEC Corporation.

## ● Maintenance Screen

When the following operation is performed during operation, the Maintenance Scree appears on the screen.

- Press the upper-left corner of the FT2J screen for three seconds or more.  
If the Base Screen is switched before three seconds have elapsed, the load operation for the maintenance screen will be canceled. Please press it again.

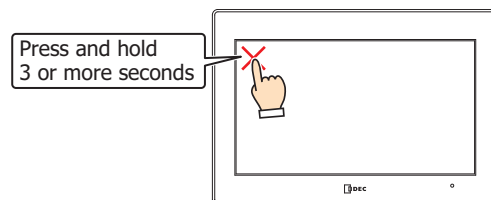

- Press the RESET switch on the back of the FT2J three times with a fine-tipped object.

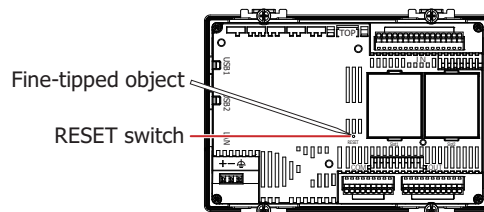

- The Maintenance Screen is not displayed in the **System Mode**.
- To display the maintenance screen, select the Enable Maintenance check box under the System tab in the Project Settings dialog box. For details, refer to Chapter 4 "3.1 System Tab" in the WindO/I-NV4 User's Manual.
- Do not touch the screen of the FT2J when operating the RESET switch.

### ● System Mode

In the System Mode, the FT2J can be changed to its initial settings and data can be initialized. Press the **System Mode** at the top of the Maintenance Screen. The Top Page Screen appears.

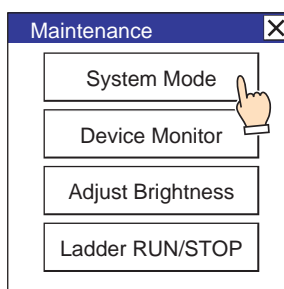

### ● Adjusting the Brightness

The brightness of the FT2J display can be adjusted on the Adjust Brightness Screen.

- 1 Press the **Adjust Brightness** at the bottom of the Maintenance Screen. The Adjust Brightness Screen appears.

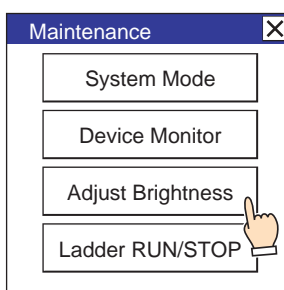

- 2 Press the << and >> at the bottom the Adjust Brightness Screen to adjust the contrast to the optimal setting.

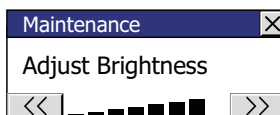

- 3 Press the **X** to close the Adjust Brightness Screen.



To adjust the brightness in the System Mode, use the << and >> buttons located at the bottom of the Top Page.

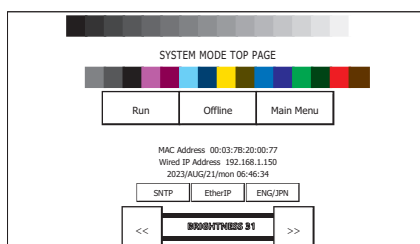

### ● Ladder RUN/STOP

Switch the ladder program between RUN and STOP by manipulating the value of the special internal relay M8000. While the ladder program is STOP, the words "Ladder STOP" flashes at the bottom right of the screen.





## 1.10 Software License Information

This product contains various open source software in addition to the software owned by IDEC Corporation. Information about open source software can be obtained from the QR code printed on the back of the FT2J.

## 2 FT1J

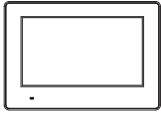
### 2.1 Packing Content

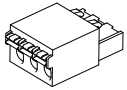
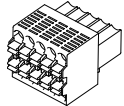
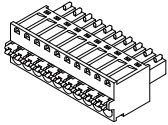
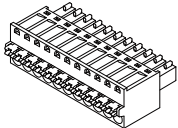
Before installing the main unit, make sure that the model you have received is what you actually ordered, and no parts are damaged to accidents during shipping.

Product Name & Dimensions	Quantity	Description
FT1J 	1	Main unit
Mounting clips 	2	-
Power supply terminal connector 	1	Removable terminal block 3-pin
Serial interface connector 	1	Removable terminal block 10-pin
Input terminal connector 	1	Removable terminal block 10-pin
Output terminal connector 	1	Removable terminal block 11-pin
Dummy cartridge 	2	Attached to the main unit

## 2.2 Type Number

LCD	Bezel Color	Input Terminal Specification	Output Terminal Specification	Type Number
4.3 inch wide TFT Color	Black	Digital sink input: 6 Analog input (shared digital sink input): 2	Relay output: 4	FT1J-4F12RAG-B
		Digital source input: 6 Analog input (shared digital sink input): 2	Transistor sink output: 4 Analog output: 2	FT1J-4F14KAG-B
		Digital sink input: 6 Analog input (shared digital sink input): 2	Transistor source output: 4 Analog output: 2	FT1J-4F14SAG-B
	Silver	Digital sink input: 6 Analog input (shared digital sink input): 2	Relay output: 4	FT1J-4F12RAG-S
		Digital source input: 6 Analog input (shared digital sink input): 2	Transistor sink output: 4 Analog output: 2	FT1J-4F14KAG-S
		Digital sink input: 6 Analog input (shared digital sink input): 2	Transistor source output: 4 Analog output: 2	FT1J-4F14SAG-S

## 2.3 Part Names

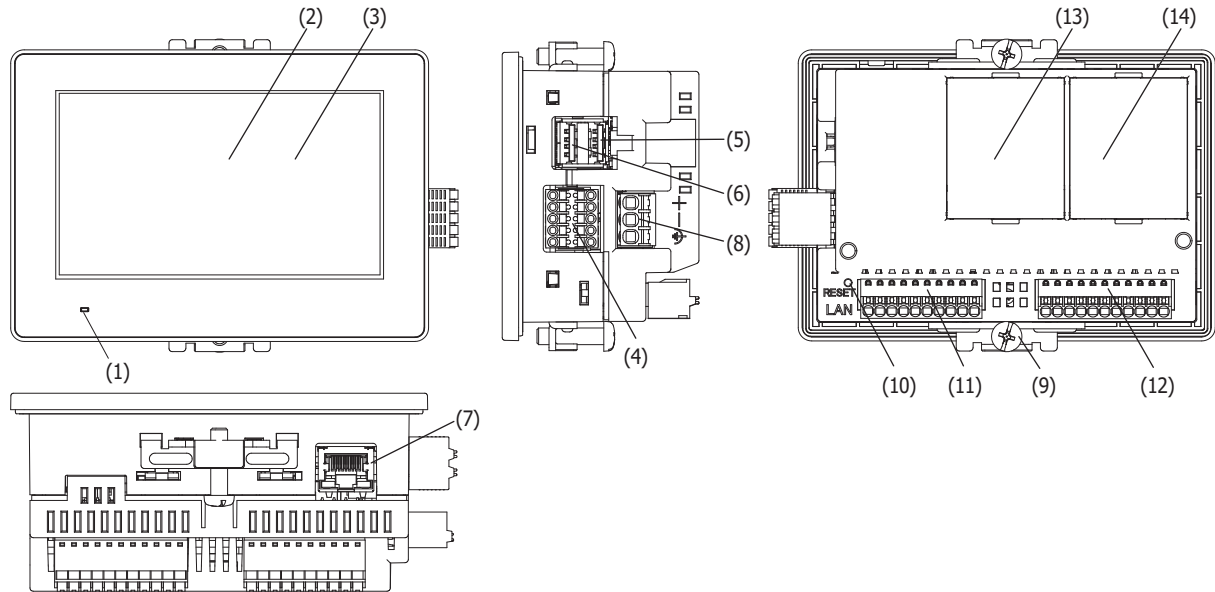

No.	Name	Description
(1)	POWER LED	Green (lit): Normal Operation Green (flash): Operating system is booting. (Normal Operation) Orange (lit): Operating system is booting. (Boot mode) Orange (flash): Preparing to boot the operating system, running in boot mode. Red (lit): Main unit is damaged. Not lit: Power is off.
(2)	Display	TFT color LCD
(3)	Touch Panel	PCAP touchscreen (Projected capacitive)
(4)	Serial Interface (COM)	RS232C, RS422/485 Connector: Terminal Block 10-pin (Push-in type) Maximum cable length: 15m (RS232C), 1200m (RS422/485)
(5)	USB Interface (USB1)	USB2.0 (Host) Connector: Type A Output current: 5V 500 mA
(6)	USB Interface (USB2)	USB2.0 (Host) Connector: Type A Output current: 5V 500 mA
(7)	Ethernet Interface (LAN)	IEEE802.3u 10BASE-T/100BASE-TX Connector: RJ-45 (With Auto MDI/MDI-X function) CAT 5 or higher, STP Maximum cable length: 100m
(8)	Power Supply Terminal	Connector (Main unit's accessories): Removable terminal block 3-pin (Push-in type)
(9)	Mounting Clip Position	2 places
(10)	RESET Switch	Tact switch
(11)	Input Terminal (IN) <sup>*1</sup>	Connector (Main unit's accessories): Removable terminal block 10-pin (Push-in type) Digital input (I0 to I5) Analog input (shared digital sink input) (I12, I13)
(12)	Output Terminal (OUT) <sup>*2</sup>	Connector (Main unit's accessories): Removable terminal block 11-pin (Push-in type) Relay Output (Q0 to Q3) Transistor sink output (Q0 to Q3), Analog output (AQ0, AQ1) Transistor source output (Q0 to Q3), Analog output (AQ0, AQ1)
(13)	Cartridge Slot (Slot1)	Slots for connecting the following I/O cartridges. For details about the cartridges, refer to Chapter 2 "I/O Cartridge" on page 2-1.
(14)	Cartridge Slot (Slot2)	Digital I/O cartridge: FC6A-PN4, FC6A-PTK4, FC6A-PTS4 Analog I/O cartridge: FC6A-PJ2A, FC6A-PJ2CP, FC6A-PK2AV, FC6A-PK2AW

\*1 When using the optional terminal connector (FT9Z-XT10V), UL certification is not applicable. In addition, the tightening torque is 1.7 lb-in (0.2 N·m) when connecting cables.

\*2 When using the optional terminal connector (FT9Z-XT11V), UL certification is not applicable. In addition, the tightening torque is 1.7 lb-in (0.2 N·m) when connecting cables.

## 2.4 External Interfaces

### ⚠ CAUTION

- Make sure to turn off the power to the FT1J before wiring each interface.
- The serial interface (COM) can be used as the RS232C and RS422/485 interfaces at same time.
- Use the SELV (Safety Extra-Low Voltage) circuit to connect the Serial, USB and Ethernet interfaces.
- Use the SELV (Safety Extra-Low Voltage) circuit and LIM (Limited Energy) when connecting a DC power supply to the Input and Output terminals.

#### ● Serial Interface (COM)

Use applicable cables for wiring and recommended ferrules (made by IDEC, Weidmüller or Phoenix Contact) as follows.

Interface Specification	RS232C, RS422/485		
Connector	Removable terminal block 10-pin		
Applicable cable	AWG16 to 28		
Conductor Type	Solid wire or Stranded wire		
Wire Strip Length *1	8 to 9 mm		
Recommended ferrule	S3TL-H025-12WJ S3TL-H034-12WT S3TL-H05-14WA S3TL-H075-14WW (IDEC)	H0,25/12 HBL H0,34/12 TK H0,5/14 OR H0,75/14 W (Weidmüller)	AI 0,25-8YE AI 0,34-8TQ AI 0,5-8WH AI 0,75-8GY (Phoenix Contact)

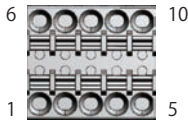

No.	Name	I/O	Function	Communication type
1	SD	OUT	Send Data	RS232C
2	RD	IN	Receive Data	
3	RS	OUT	Request to Send	
4	CS	IN	Clear to Send	
5	SG	-	Signal Ground	RS422/485
6	SDA	OUT	Send Data (+)	
7	SDB	OUT	Send Data (-)	
8	RDA	IN	Receive Data (+)	
9	RDB	IN	Receive Data (-)	
10	SG	-	Signal Ground	

\*1 Strip the sheath of the wire 8 to 9 mm from the end.

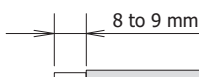

### Using RS422/485 interface

FT1J is not equipped with terminating resistor. Insert a terminating resistor of an appropriate value (about 100 to 120 Ohm, 1/2 W minimum) between terminal number 8 (RDA) and terminal number 9 (RDB), if necessary.

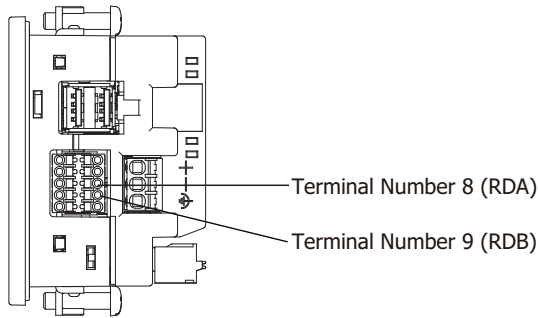

For inserting and removing wires, refer to "2.8 Wiring" on page 1-44.

### ● Input Terminal (IN)

Use applicable cables for wiring and recommended ferrules (made by IDEC, Weidmüller or Phoenix Contact) as follows.

Product Name	Input terminal connector (Main unit's accessories)			Input terminal connector (Optional parts <sup>*1</sup> )		
Connector	Removable terminal block 10-pin (Push-in type)			Removable terminal block 10-pin (Screw type)		
Applicable cable	AWG16 to 28			AWG14 to 28		
Conductor Type	Solid wire or Stranded wire					
Wire Strip Length <sup>*2</sup>	8 to 9 mm			6 to 7 mm		
Recommended ferrule	S3TL-H025-12WJ S3TL-H034-12WT S3TL-H05-14WA S3TL-H075-14WW (IDEC)	H0,25/12 HBL H0,34/12 TK H0,5/14 OR H0,75/14 W (Weidmüller)	AI 0,25-8YE AI 0,34-8TQ AI 0,5-8WH AI 0,75-8GY (Phoenix Contact)	S3TL-H025-12WJ S3TL-H034-12WT S3TL-H05-14WA (IDEC)	H0,25/12 HBL H0,34/12 TK H0,5/14 OR (Weidmüller)	AI 0,25-8YE AI 0,34-8TQ AI 0,5-8WH (Phoenix Contact)
Input Points	8					
Rated Input Voltage	24V DC					
Input Voltage Range	0 to 28.8V DC					

\*1 FT9Z-XT10V (Right angle type)

\*2 Strip the sheath of the wire from the end.

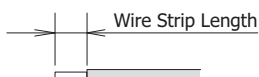



Digital Input

Type Number	FT1J-4F12RAG-*, FT1J-4F14SAG-*		FT1J-4F14KAG-*
Input Circuit Type	Sink input		Source input
Input Points (Terminal Number)	6 points in 1 common line (I0 to I5 / Power supply(-) terminal)		6 points in 1 common line (I0 to I5 / Power supply(+) terminal)
Rated Input Current	I0 to I5	4.6 mA/point	5.2 mA/point
Input Impedance	I0 to I5	5.2 k $\Omega$	4.7 k $\Omega$
Input Delay Time	Turn ON Time	I0 to I5	25 $\mu$ s maximum + software filter setting
	Turn OFF Time	I0 to I5	25 $\mu$ s maximum + software filter setting
Isolation	Between Input Terminal and Internal Circuit	Not isolated	
	Between Input Terminals	Not isolated	
Input Type	Type1 (IEC 61131-2)		
External Load for I/O Interconnection	Not isolated		
Signal Determination Method	Static		
Cable Length in compliance with electromagnetic immunity	3 m		

### ■ Operating Ranges

#### Sink Input (I0 to I5)

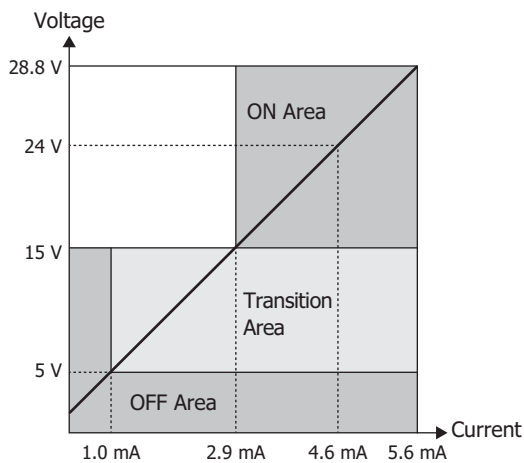

#### Source Input (I0 to I5)

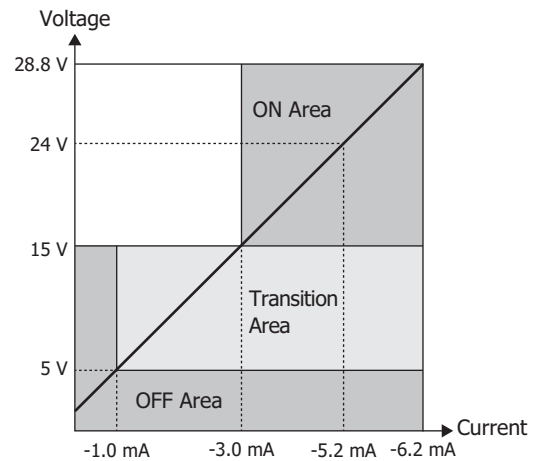

### ■ Input Equivalent Circuit

#### Sink Input (I0 to I5)

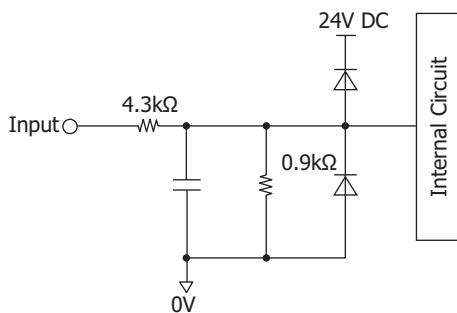

#### Source Input (I0 to I5)

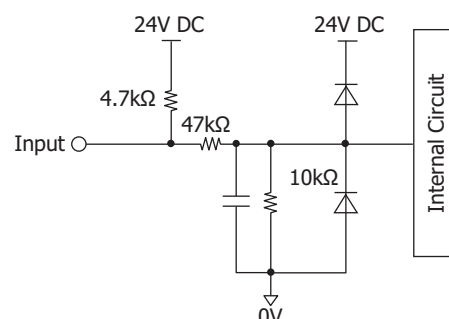

Analog Input (shared digital sink input)

Input Electrical Characteristic <sup>*1</sup>		Voltage	Current
Input Points (Terminal Number/Common Line Name)		1 points in 1 common line (I12, I13/COM0(-) terminal, COM1(-) terminal)	
Input Range		0 to 10V DC	4 to 20 mA
Input Impedance		78kΩ	250kΩ
Digital Resolution		4096 (12 bit)	
Data Type		Can be set for each channel. Binary data: 0 to 4095 Optional range <sup>*2</sup> : -32768 to 32767	
AD Conversion	Sampling time	5 msec max.	
	Sample Repetition Time	5 msec max.	
	Total Input Delay Time	6 msec + 1 scan time	
	Type of Input	Single-ended	
	Operation Mode	Self-scan	
	Conversion Method	SAR	
Input Error	Maximum Error at 25°C	±3.0% of full scale	
	Temperature Coefficient	±0.04% of full scale/°C	
	Maximum Error	±5.0% of full scale	
Status Display		Device Monitor screen (LCD display)	
Noise Resistance	Maximum Temporary Deviation during Electrical Noise Tests	±5.0% of full scale	
	Input Filter	Yes	
	Recommended Cable for Noise Immunity	Shielded cable	
Calibration to Maintain Rated Accuracy		Not possible	
Maximum Permanent Allowed Overload (No Damage)		28.8V DC	
Overload Status (Outside Input Range) Detection		Detectable	
Isolation	Between Input Terminal and Internal Circuit	Not isolated	
	Between Input Terminals	Not isolated	
Used as Digital Input	Digital Input Type	— (IEC 61131-2 digital input type is not supported)	
	Input Threshold	ON voltage: 15V min.	ON current: 0.20 mA min.
		OFF voltage: 5V max.	OFF current: 0.06 mA max.

\*1 Can be set by application software.

\*2 This function is used the analog value converting it to the specified range.

## ■ Operating Ranges

### I12, I13

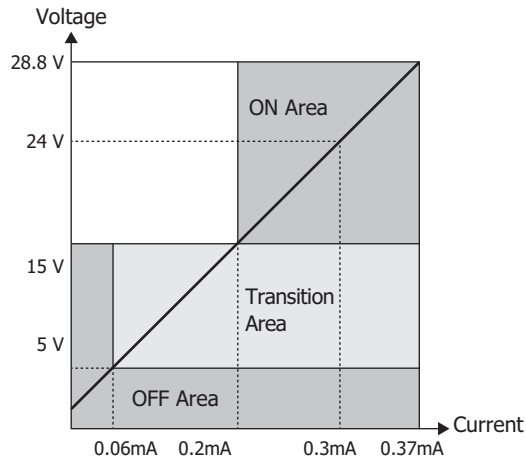

## ■ Input Equivalent Circuit

### I12, I13

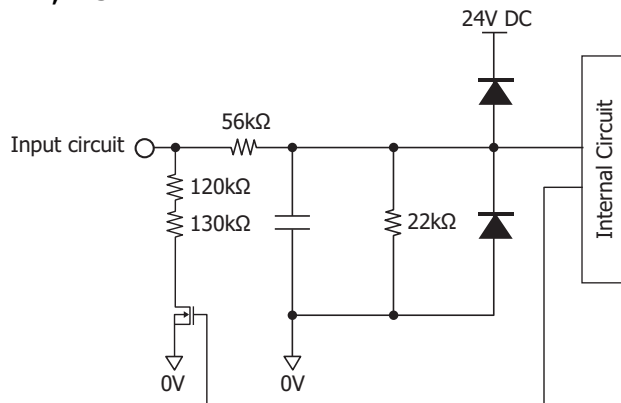

## Pulse Input

The maximum input frequency varies based on the input terminal and function.

Input Terminal		I0	I1	I2	I3	I4	I5	
Function*1	High-speed counter	Adding counter	20 kHz	-	20 kHz	20 kHz	20 kHz	20 kHz
		Up/down selection reversible counter	20 kHz	-	-	-	-	-
		Dual-pulse reversible counter	20 kHz	20 kHz	-	-	-	-
		2-edge count	10 kHz	10 kHz	-	-	-	-
		4-edge count	5 kHz	5 kHz	-	-	-	-
	Catch input	20 kHz	-	20 kHz	20 kHz	20 kHz	20 kHz	
	Interrupt input	20 kHz	-	20 kHz	20 kHz	20 kHz	20 kHz	
Frequency measurement	-	-	20 kHz	20 kHz	20 kHz	-		

\*1 Can be set by application software.

## ● Output Terminal (OUT)

Use applicable cables for wiring and recommended ferrules (made by IDEC, Weidmüller or Phoenix Contact) as follows.

Product Name	Output terminal connector (Main unit's accessories)			Output terminal connector (Optional parts* <sup>1</sup> )		
Connector	Removable terminal block 11-pin (Push-in type)			Removable terminal block 11-pin (Screw type)		
Applicable cable	AWG16 to 28			AWG14 to 28		
Conductor Type	Solid wire or Stranded wire					
Wire Strip Length* <sup>2</sup>	8 to 9 mm			6 to 7 mm		
Recommended ferrule	S3TL-H025-12WJ S3TL-H034-12WT S3TL-H05-14WA S3TL-H075-14WW (IDEC)	H0,25/12 HBL H0,34/12 TK H0,5/14 OR H0,75/14 W (Weidmüller)	AI 0,25-8YE AI 0,34-8TQ AI 0,5-8WH AI 0,75-8GY (Phoenix Contact)	S3TL-H025-12WJ S3TL-H034-12WT S3TL-H05-14WA (IDEC)	H0,25/12 HBL H0,34/12 TK H0,5/14 OR (Weidmüller)	AI 0,25-8YE AI 0,34-8TQ AI 0,5-8WH (Phoenix Contact)

### Relay Output

Type Number	FT1J-4F12RAG-*	
Output Points (Terminal Number)	4 (Q0 to Q3)	
Output Type	1a contact	
Maximum Load Current	1	2 A max.
	1 common line	2 A max.
Minimum Switching Load	1 mA, 5V DC (reference value)	
Initial Contact Resistance	30 mΩ max.	
Electrical Life	100,000 operations min. (rated resistive load 1,800 operations/hour)	
Mechanical Life	20,000,000 operations min. (no load 18,000 operations/hour)	
Rated Load	240V AC 2 A, 30V DC 2 A	
Withstand Voltage	Between Output Terminal and Internal Circuit	2,300V AC 5 mA, 1 minute
	Between Output Terminals (COMs)	
Status Display	Device Monitor screen (LCD display)	



When the output voltage of FT1J-4F12RAG-\* exceeds 200V AC, use adjacent COMs with a single power source.

### Output Delay

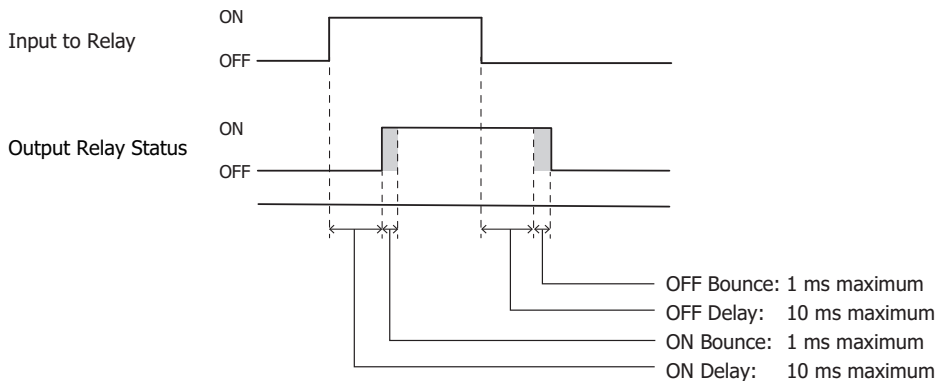

\*1 FT9Z-XT11V (Right angle type)

\*2 Strip the sheath of the wire from the end.

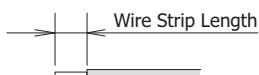

Transistor Output

Type Number	FT1J-4F14KAG-*	FT1J-4F14SAG-*
Output Circuit Type	Sink output	Source output
Output Points	4 (Q0 to Q3)	
Rated Load Voltage	24V DC	
Operating Input Voltage Range	20.4 to 28.8 DC	
Maximum Load Current	1	0.5 A
	1 common line	2 A
Voltage Drop (ON Voltage)	1V max. (Voltage between COM and output terminal when ON)	
Maximum Inrush Current	1 A max.	
Leakage Current	0.1 mA max.	
Inductive Load	L/R=10 ms (28.8V DC, 1 Hz)	
	100 mA max., 24V DC	
External Current Draw	V(+) terminal supply power	COM2(+) terminal supply power
Isolation	Photocoupler isolated	
Status Display	Device Monitor screen (LCD display)	

## ■ Output Equivalent Circuit

## FT1J-4F14KAG-\*

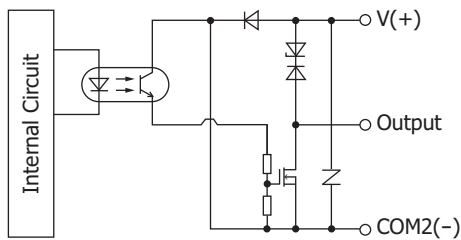

## FT1J-4F14SAG-\*

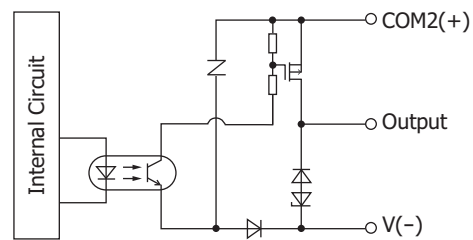

## Analog Output

Type Number	FT1J-4F14*AG-*	
Output Electrical Characteristic*1	Voltage	Current
Output Points (Terminal Number/Common Line Name)	1 / 1 common line (AQ0, AQ1/COM3(-) terminal, COM4(-) terminal)	
Output Range	0 to 10V DC	4 to 20 mA DC
Output Load	Impedance	2 k $\Omega$ or higher
	Load Type	Resistive load
DA Conversion	Scan Time	1 scan
	Settling time	1 ms or lower
	Total Output System Transfer Time	1 ms + 1 scan time
Output Error	Maximum Error at 25°C	$\pm 0.3\%$ of full scale
	Temperature Coefficient	$\pm 0.02\%$ of full scale/°C
	Reproducibility after Stabilization Time	$\pm 0.4\%$ of full scale
	Non-linearity	$\pm 0.01\%$ of full scale
	Output Ripple	30 mV maximum
	Overshoot	0% *2
Data	Maximum Error	$\pm 1.0\%$ of full scale
	Digital Resolution	4,096 (12 bits)
	Data Type	Can be set for each channel. Binary data: 0 to 4095 Optional range*3: -32768 to 32767
	Monotonicity	Yes
Noise Resistance	Current Loop Open	Not detectable
	Maximum Temporary Deviation during Electrical Noise Tests	$\pm 5.0\%$ or less of full scale
	Recommended Cable for Noise Immunity	Shielded cable
Effect of Improper Output Connection	No damage	
Calibration to Maintain Rated Accuracy	Not possible	

### ■ Output Equivalent Circuit

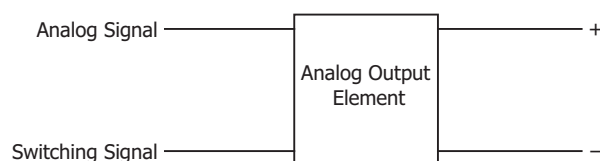

## Pulse Output

Type Number	FT1J-4F14*AG-*
Output Points	4 (Q0 to Q3)
Maximum output pulse frequency	20kHz
PWM output	Duty cycle: 0.1 to 100.0 (increments of 0.1%) Output pulse frequency: 30 to 1000 (increments of 1Hz) When the pulse OFF time is shorter than 25 $\mu$ s, the pulse ON ratio is adjusted so that the OFF time is 25 $\mu$ s and output the signal. When the pulse ON time is shorter than 25 $\mu$ s, the pulse OFF ratio is adjusted so that the ON time is 25 $\mu$ s and output the signal.

\*1 Can be set by application software.

\*2 Overshoot may occur at light loads. The occurrence of overshoot can be controlled by inserting damping resistance into the circuit. A general guide for the damping resistance value is about 150  $\Omega$  including the input line impedance for the destination.

\*3 This function is used the analog value converting it to the specified range.

## 2.5 Specifications

### ■ Applicable Standards

Safety Standards	UL61010-1, UL61010-2-201, CSA C22.2 No.61010-2-201 (c-UL), UL121201, CSA C22.2 No.61010-1-12 (c-UL), CSA C22.2 No.213 (c-UL)
EMC Standards	IEC/EN 61131-2

### ■ Environmental Specifications

Ambient Operating Temperature	-20 to +55°C*1 (no freezing)
Ambient Operating Humidity	10 to 95% RH (no condensation)
Ambient Storage Temperature	-20 to +70°C (no freezing)
Ambient Storage Humidity	10 to 95% RH (no condensation)
Altitude	0 to 2,000 m (1,013 to 795hPa) during operation 0 to 3,000 m (1,013 to 701hPa) during transport
Pollution Degree	2
Corrosion Immunity	Free from corrosive gases

### ■ Electrical Specifications

Type Number	FT1J-4F12RAG-*	FT1J-4F14*AG-*
Rated Voltage	24V DC	
Power Consumption	13W maximum	15W maximum
Not using the USB1 and USB2 interfaces, the IN and OUT terminals, and the Slot1 and Slot2 slots. When Backlight OFF	5W maximum	
	3W maximum	
Power Voltage Range	20.4 to 28.8V DC	
Allowable Momentary Power Interruption	10 ms maximum (Power supply voltage: 24.0V DC to 28.8V DC) 5 ms maximum (Power supply voltage: 20.4V DC to 24.0V DC)	
Inrush Current	40 A maximum	
Dielectric Withstand Voltage	500V AC, 5 mA, 1 minute (between power and earth terminals) 500 V AC, 5 mA, 1 minute (between input and earth terminals) 2300 V AC, 5 mA, 1 minute (between relay output and earth terminals) 500 V AC, 5 mA, 1 minute (between transistor output and earth terminals) 500 V AC, 5 mA, 1 minute (between power and transistor output terminals) 2300 V AC, 5 mA, 1 minute (between power and relay output terminals) 500 V AC, 5 mA, 1 minute (between input and transistor output terminals) 2300 V AC, 5 mA, 1 minute (between input and relay output terminals)	

### ■ Construction Specifications

Type Number	FT1J-4F12RAG-*	FT1J-4F14*AG-*
Vibration Resistance	5 to 8.4Hz amplitude 3.5mm, 8.4 to 150Hz acceleration 9.8m/s <sup>2</sup> 10 times on each of three mutually perpendicular axes (IEC 61131-2)	
Shock Resistance	98m/s <sup>2</sup> , 11ms (3 shocks on each of three mutually perpendicular axes) (IEC 61131-2)	147m/s <sup>2</sup> , 11ms (3 shocks on each of three mutually perpendicular axes) (IEC 61131-2)

\*1 For details about the restrictions due to the ambient operating temperature, refer to "Restrictions due to mounting orientation" on page 1-43.

## ■ Function Specifications

Display	LCD Type <sup>*2</sup>	TFT color LCD
	Display Colors	16.77 M
	Effective Display Area	95.04 (W) × 53.856 (H) mm
	Display Resolution	480 (W) × 272 (H) dots
	Dot pitch	0.198 (W) × 0.198 (H) mm
	View angle	Top/Bottom/Left/Right: 80°
	Brightness of LCD only	500 cd/m <sup>2</sup>
	Brightness Adjustment	32 levels
	Backlight	LED (white)
	Backlight Life <sup>*3</sup>	Approx. 50,000 hours (The time until brightness becomes 50% of the initial value)
Touch Panel	Switch Type	Projected Capacitive
	Multiple Operations	Possible (2-point touch)
User Memory		Approx. 24 MB
Backup time of the real-time clock (Ambient Operating Temperature at 25°C)		Typ. 20 days <sup>*5</sup>
Backup Data	Keep by a large-capacity capacitor	Clock Data
	Save to non-volatile memory	Log data, HMI Keep Relays, HMI Keep Registers, Internal Relays, Shift Registers, Counters, Data Registers
Buzzer output		Single tone (tone length is adjustable)
Degree of Protection <sup>*4</sup>		Panel thickness is 1mm or more and less than 1.6mm: IP65F (IEC 60529) Panel thickness is 1.6mm or more and 5mm or less: IP66F, IP67F (IEC 60529), TYPE 4X (indoor use only), TYPE 13
Weight (approx.)		320g

\*2 Please be aware that small black and bright dots might show up on LCD Screen: it is not a failure or malfunction.

\*3 The life of the LCD itself at an ambient operating temperature of 25°C. This is not a guaranteed value. The actual life depends on the environment and conditions of use.

\*4 It is a protection structure for the operating surface of HMI, which is attached to a panel. Although protection structure suffices every test conditions, it does not guarantee to operate under all of the environmental condition.

As for IP65F/IP66F/IP67F oilproof structure, it suffices oilproof test conditions. Conditions are listed in the document that comes with Japanese Industrial Standard JIS C 0920.

Protection structure do not gurantee usage under long exposure to oil or usage of oil that is not prescribed in the document. Please test/check beforehand to avoid trouble.

IP ratings are not applicable to UL certification.

\*5 If the power interruption period exceeds the Backup time of the real-time clock, the error message "Initialize clock data" will be displayed when the power is turned on, and the clock data will be initialized to 00:00:00 on January 1, 2000.



## ■ EMC Specifications

Radiated Emission	Class A: 10m 40dB $\mu$ V/m quasi-peak (30M to 230MHz) 47dB $\mu$ V/m quasi-peak (230M to 1GHz) Class A: 3m 76dB $\mu$ V/m (Peak), 56dB $\mu$ V/m (AVG) (1G to 3GHz) 80dB $\mu$ V/m (Peak), 60dB $\mu$ V/m (AVG) (3G to 6GHz)
Electrostatic Discharge	Contact: $\pm$ 6kV Air: $\pm$ 8kV
Electromagnetic Field	10V/m (80M to 1000MHz) 3V/m (1.4G to 2.0GHz) 3V/m (2.0G to 2.7GHz) 3V/m (2.7G to 6.0GHz) 80% AM (1kHz)
Fast Transient Burst	Power: $\pm$ 2kV Communication cable: $\pm$ 1kV
Surge Immunity	$\pm$ 500V (between +24V and 0V) $\pm$ 500V (between +24V and FE, 0 and FE)
Conducted Radio Frequency Immunity	10V (Power, Communication cable) (150k to 80MHz) 80% AM (1kHz)

## 2.6 Dimensions

Unit: mm

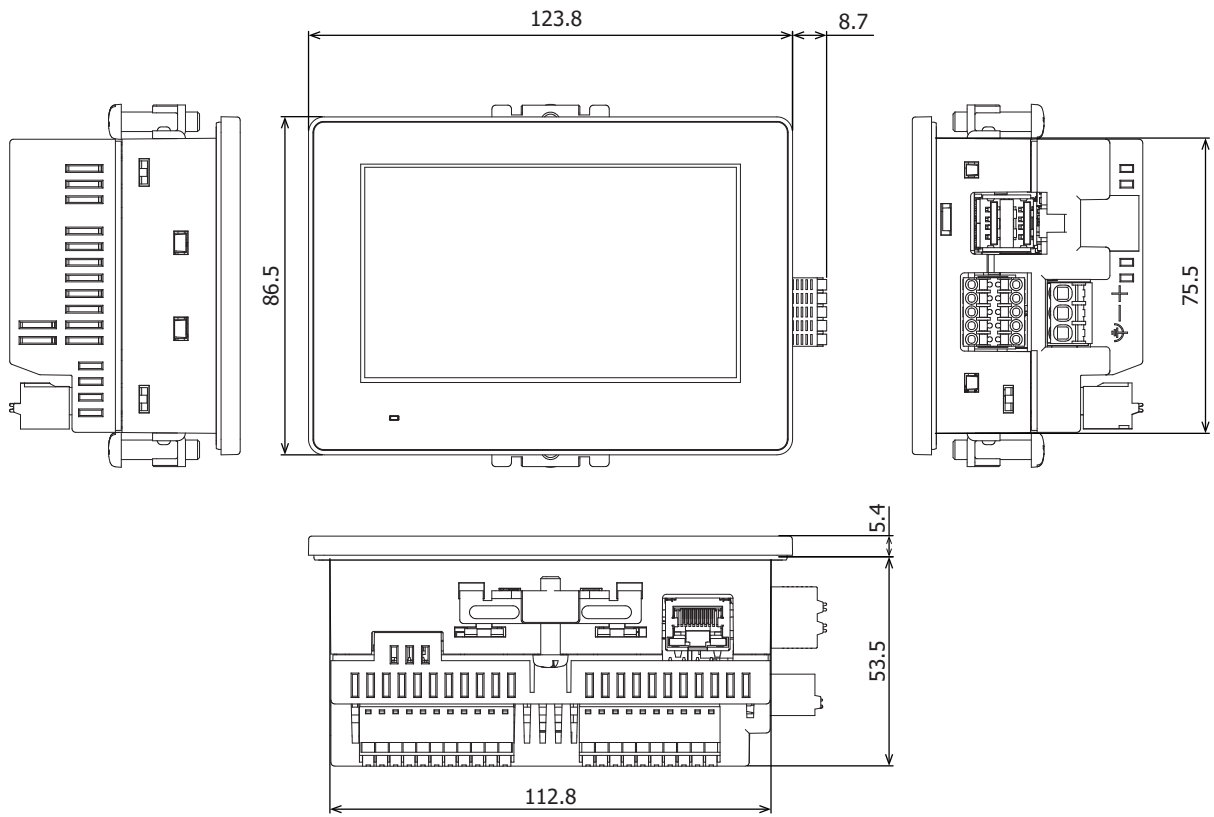

<Cable Attached Dimensions>

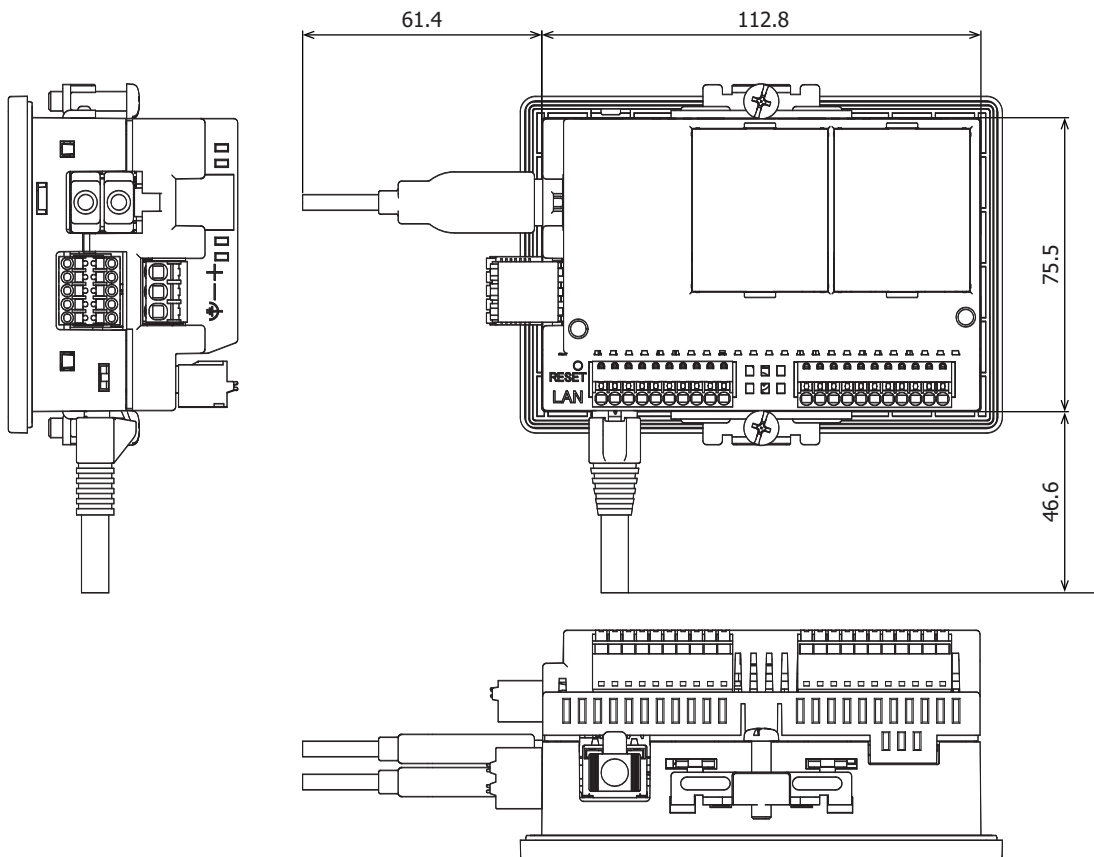

Depending on the type of connection cable used the dimensions shown above will change. The dimensions given here are representative values and are intended for reference only.

### ● About the printed contents of the main unit

"Mark A" indicates that you can refer to the instruction sheet by using the QR code. For details about Conductor material and wire size, refer to "2.4 External Interfaces" on page 1-29 and "2.8 Wiring" on page 1-44.

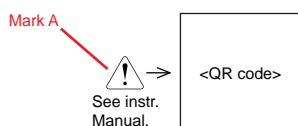

## 2.7 Installation

### ● Operating Environment

For designed performance and safety of the FT1J, do not install the FT1J in the following environments:

- Where dust, briny air, or iron powder exist.
- Where oil or chemical splashes for a long time.
- Where space is filled with oil mist.
- Where direct sunlight falls on the FT1J.
- Where strong ultraviolet rays fall on the FT1J.
- Where corrosive or combustible gasses exist.
- Where shocks or vibrations are transmitted.
- Where condensation occurs due to rapid temperature change.
- Where high-voltage or arc-generating equipment (electromagnetic contactors or circuit protectors) exists in close proximity.

### ● Ambient Temperature

- Allow sufficient space for ventilation, and install the equipment away from heat sources.
- Allow at least 100mm between the FT1J and walls or other equipment.
- Do not install the FT1J where the ambient temperature exceeds the rated ambient operating temperature range. When mounting the FT1J in such locations, provide a forced air-cooling fan or air-conditioner to keep the ambient temperature within the rated temperature range.
- The FT1J is designed to install on a vertical plane so that natural air-cooling is provided. If you install it using any other orientation, use forced-air cooling, or lower the ambient operating temperature.

### ● About Derating

The FT1J suppresses the temperature rise inside the product by reducing the backlight brightness when the ambient operating temperature becomes high.

The relationship between the ambient operating temperature and brightness is when installed on a vertical landscape as follows.

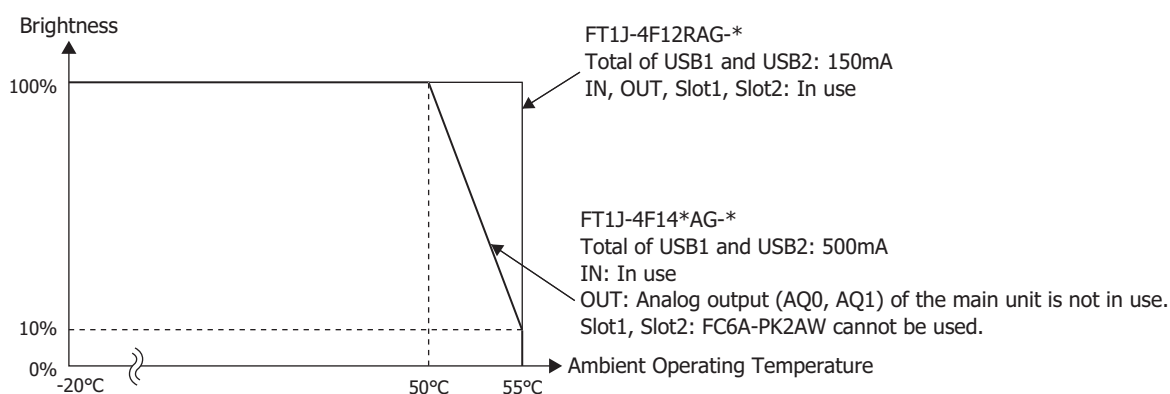

Brightness reduction occurs depending on the usage of the USB interface, IN, OUT, and cartridge slots.

Depending on each product the values shown above will change. The values given here are representative values are intended for reference only.

## ● Installation

- Make a panel cut-out on the panel with the dimensions shown below.

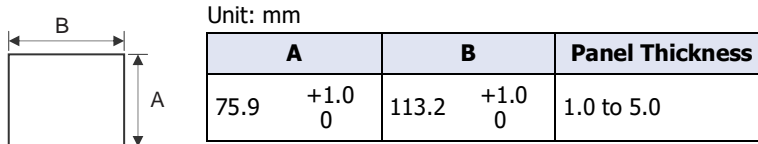

- Use the attached mounting clips to tighten the screws evenly to mount panel: screws must be applied on total of two places with the specified torque 0.3 to 0.4 N·m.

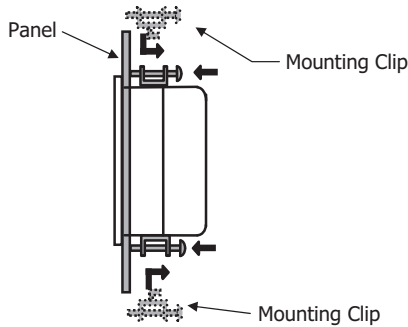

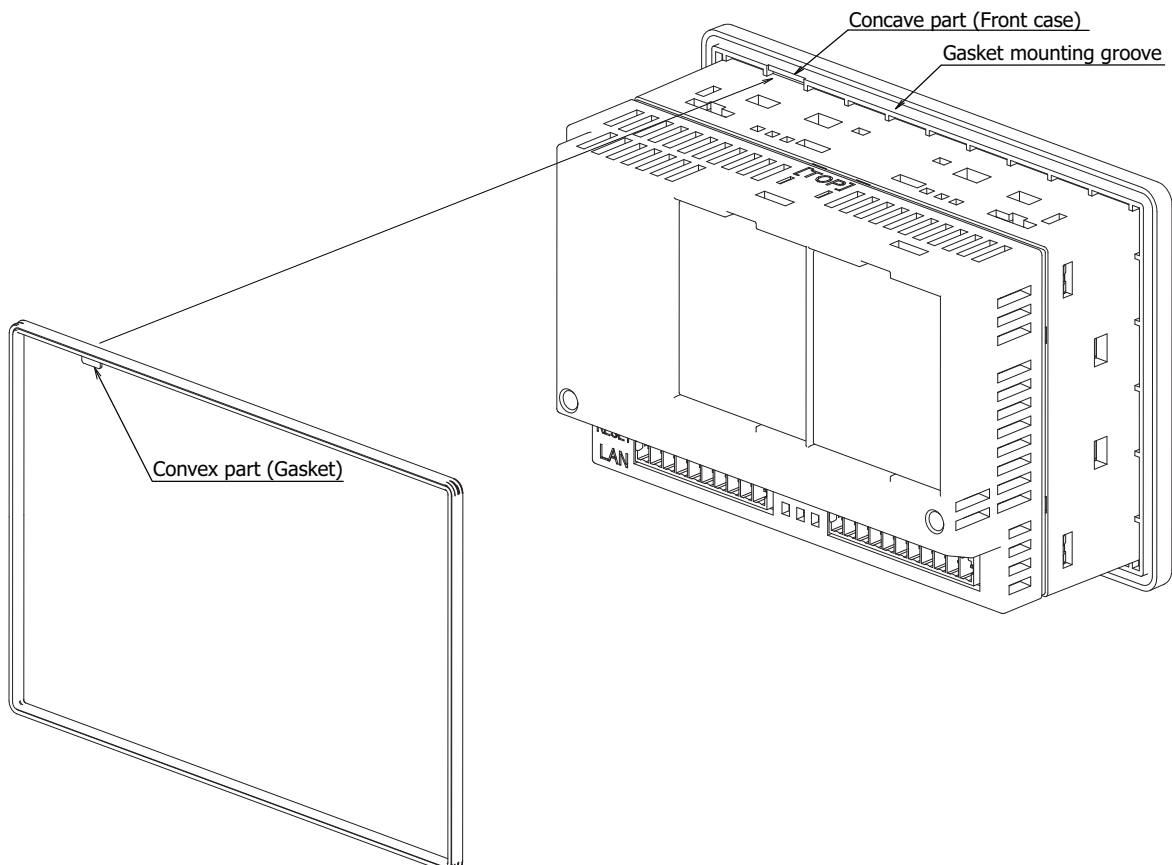

### ⚠ CAUTION

- Mount the FT1J on a rigid panel.
- Do not tighten with excessive force, otherwise the FT1J may warp the display, or impair the waterproof characteristics.
- If the mounting clips are tightened obliquely to the panel, the FT1J may fall off the panel.
- When installing the FT1J into a panel cut-out, make sure that the gasket is not twisted. Especially when re-installing, take special care because any twists in the gasket will impair the waterproof characteristics. Also, if the gasket comes off the main unit, align the convex part of the gasket with the concave part of the front case, and then insert the gasket fully into the gasket mounting groove without twisting it.

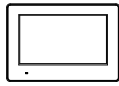
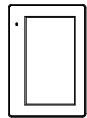
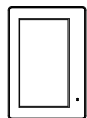

● Restrictions due to mounting orientation

The FT1J is designed to install on a vertical landscape. The ambient operating temperature and the output current of the USB interface (total of USB1 and USB2) are limited as shown in the table below.

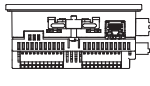
Orientation		Ambient Operating Temperature: Output current limitation of USB interface	
		FT1J-4F12RAG-*	FT1J-4F14*AG-*
Vertical	 Landscape	-20°C to +40°C : 1000mA +40°C to +45°C : 500mA +45°C to +55°C : 150mA	-20°C to +40°C : 1000mA +40°C to +55°C : 500mA
	 Portrait (Clockwise)	-20°C to +40°C : 1000mA +40°C to +45°C : 500mA +45°C to +50°C : 150mA +50°C to +55°C : 0mA	-20°C to +40°C : 1000mA +40°C to +50°C : 500mA +50°C to +55°C : 150mA
	 Portrait (Counter Clockwise)	-20°C to +40°C : 1000mA +40°C to +45°C : 500mA +45°C to +55°C : 150mA	-20°C to +40°C : 1000mA +40°C to +55°C : 500mA
	 Landscape (Rotate 180°)		
 Horizontal		-20°C to +40°C : 1000mA +40°C to +45°C : 500mA +45°C to +50°C : 150mA +50°C to +55°C : 0mA	-20°C to +40°C : 1000mA +40°C to +50°C : 500mA +50°C to +55°C : 150mA



- When installing the FT1J in a diagonal, the limitations are same as a horizontal.
- Confirm the visibility of the display in a final installation.
- Depending on the ambient operating temperature, the following parts cannot be used with the FT1J-4F14\*AG-\*.
  - 45°C or higher: Analog I/O cartridge FC6A-PK2AW in cartridge slots (Slot1, Slot2)
  - 50°C or higher: Analog output (AQ0, AQ1) of output terminal (OUT)

For details about how to install the cartridge, refer to Chapter 2 "1.6 Install and remove" on page 2-5 or Chapter 2 "2.6 Install and remove" on page 2-13.

## 2.8 Wiring

### ⚠ CAUTION

- Turn off the power supply before wiring.
- Make the wiring as short as possible and run all wires as far away as possible from high-voltage and large-current cables. Follow all the procedures and precautions when wiring the FT1J.
- Separate the FT1J power supply wiring from the power lines of I/O devices and motor equipment.
- Ground the functional earth terminal to make sure of correct operation.
- Use the SELV (Safety Extra-Low Voltage) circuit and LIM (Limited Energy) circuit for power supply.
- Use Copper Conductors Only.

#### ● Terminal Arrangement and Wiring Examples

##### FT1J-4F12RAG-B, FT1J-4F12RAG-S

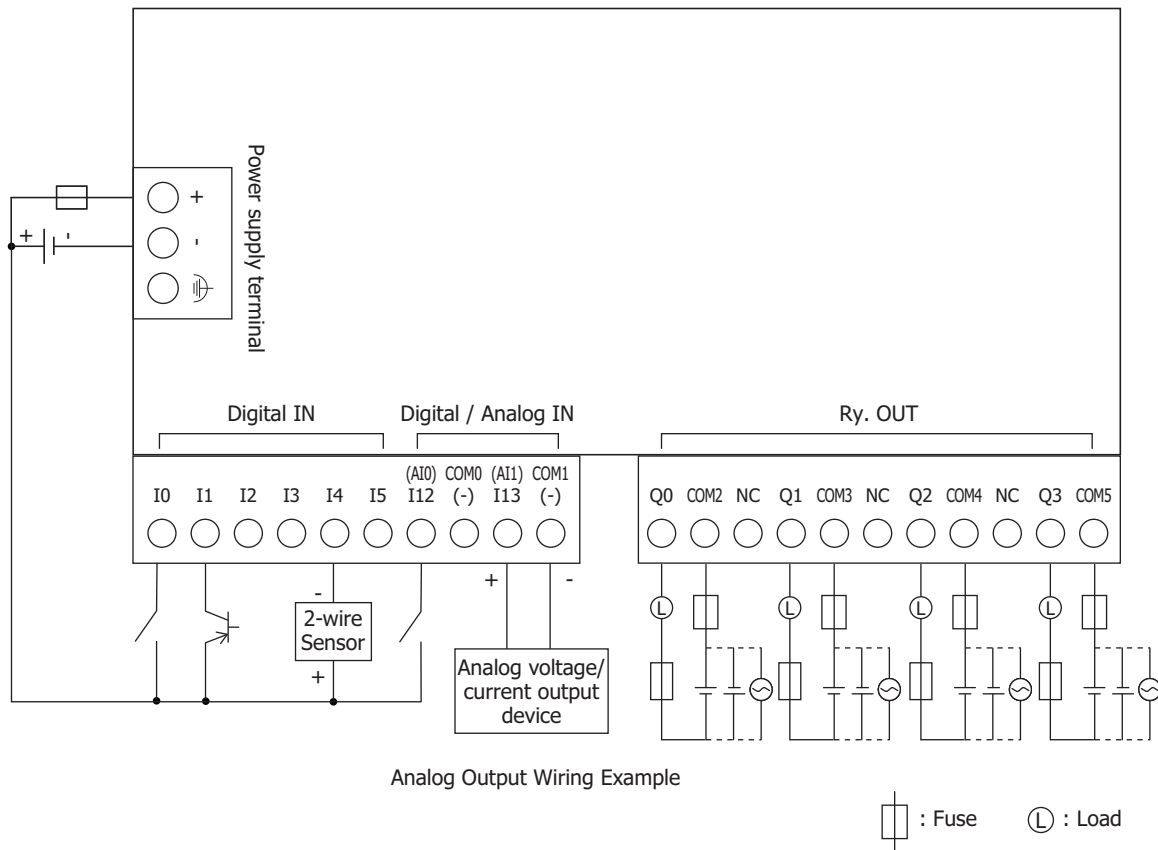

**FT1J-4F14KAG-B, FT1J-4F14KAG-S**

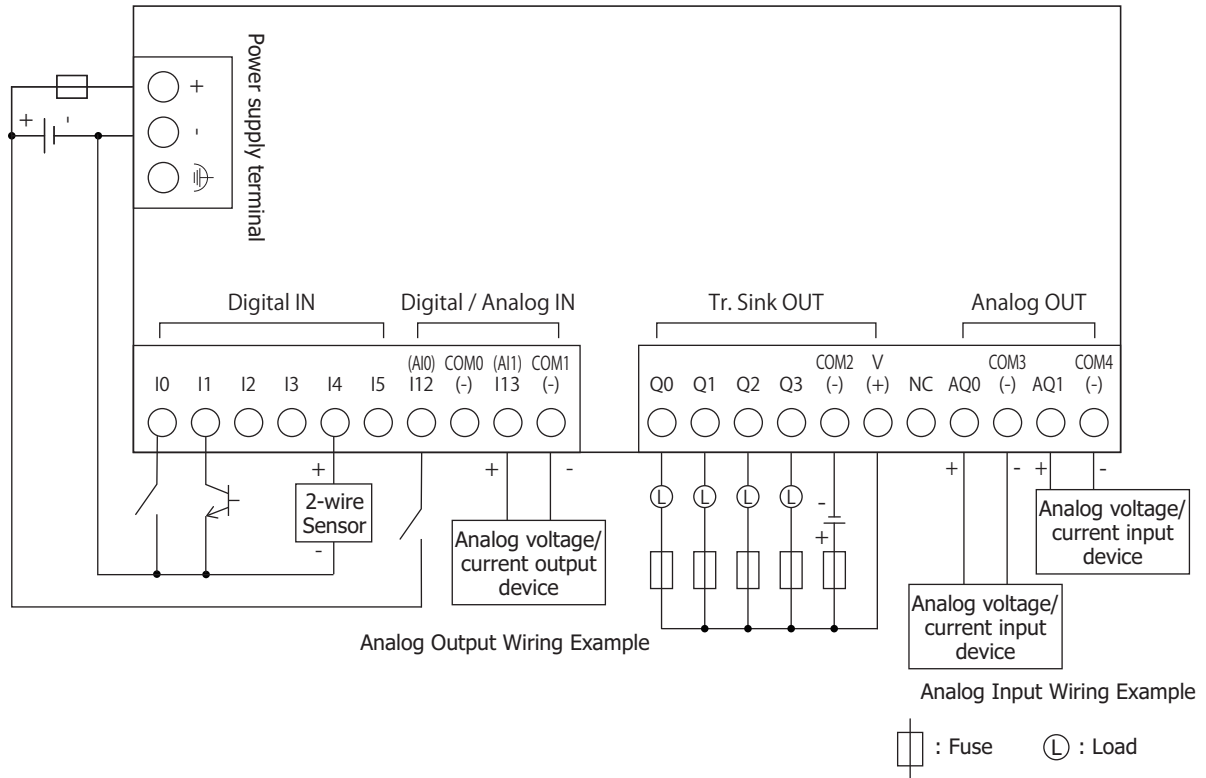

**FT1J-4F14SAG-B, FT1J-4F14SAG-S**

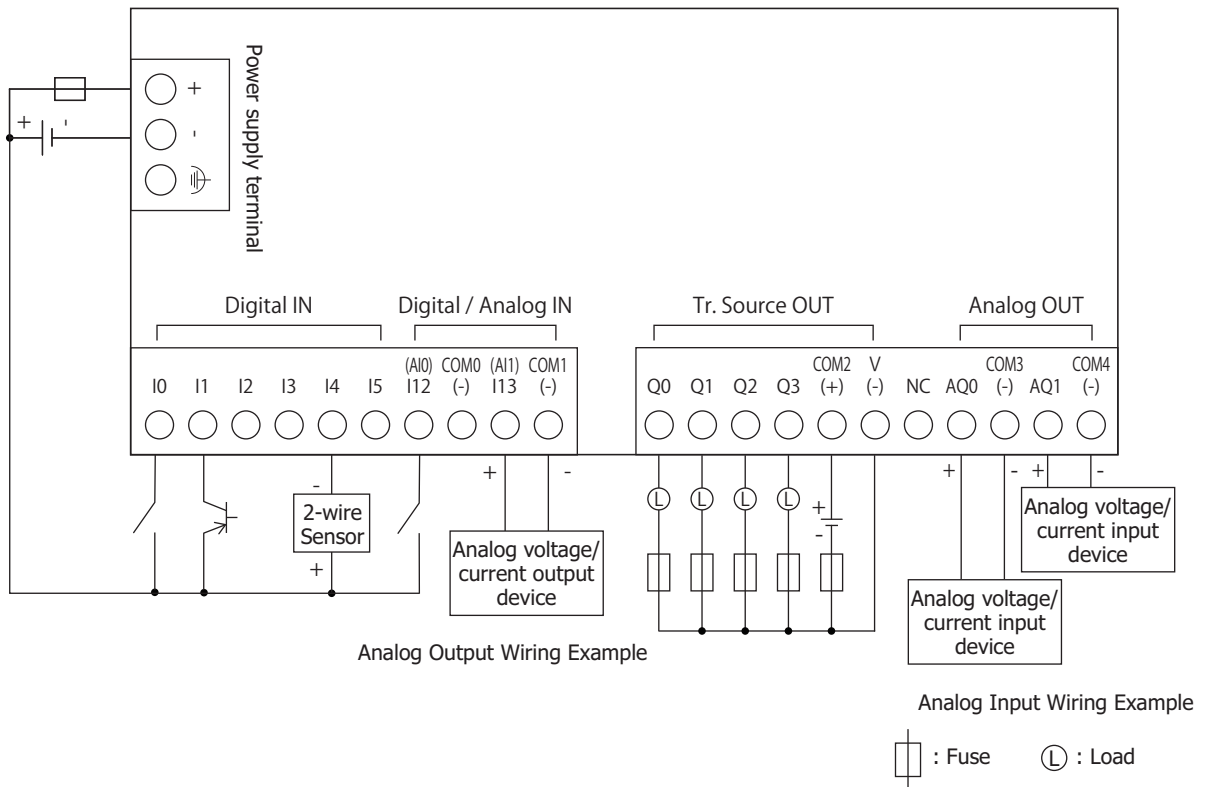

● Power Supply Terminal

- Pin assignment is shown in the following table.

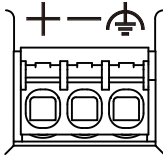

+	Power supply (24V DC)
-	Power supply (0V)
⏏	Functional Earth (FE)

- Use applicable cables for wiring and recommended ferrules (made by IDEC, Weidmüller or Phoenix Contact) as follows.

Product Name	Power supply terminal connector (Main unit's accessories)			Power supply terminal connector (Optional parts <sup>*1</sup> )		
Connector	Removable terminal block 3-pin (Push-in type)					
Applicable cable	AWG12 to 24			AWG12 to 26		
Conductor Type	Solid wire or Stranded wire					
Wire Strip Length <sup>*2</sup>	10 to 11 mm			12 to 13 mm		
Recommended ferrule	S3TL-H025-12WJ S3TL-H034-12WT S3TL-H05-14WA S3TL-H075-14WW (IDEC)	H0,25/12 HBL H0,34/12 TK H0,5/14 OR H0,75/14 W (Weidmüller)	AI 0,25-8YE AI 0,34-8TQ AI 0,5-8WH AI 0,75-8GY (Phoenix Contact)	S3TL-H025-12WJ S3TL-H034-12WT S3TL-H05-14WA S3TL-H075-14WW (IDEC)	H0,25/12 HBL H0,34/12 TK H0,5/14 OR H0,75/14 W (Weidmüller)	AI 0,25-8YE AI 0,34-8TQ AI 0,5-8WH AI 0,75-8GY (Phoenix Contact)

● Caution when inserting and removing wires

- When connecting a wire that has not been treated with a tip, such as a stranded wire, you can connect it by inserting the wire all the way in while pressing the pusher, and then releasing the pusher.
- When connecting wires with ferrules, connect the ferrules to the terminal block so that the long side is horizontal. (See the figure below.)

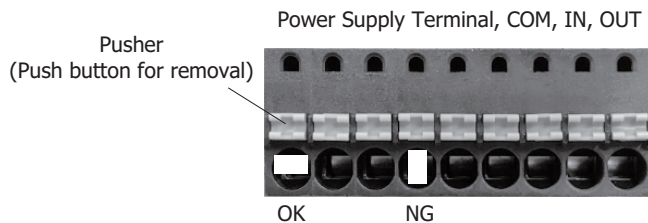

- Do not pull out the wire without pressing the pusher. When pulling out the wire, use a flat blade screwdriver, etc., and pull the wire straight out while pressing the pusher with about 20 N of force.
- Be careful not to damage the push-in terminals. When pressing the pusher, do not apply more than 40N of force.

\*1 FT9Z-1X03V (Right angle type)

\*2 Strip the sheath of the wire from the end.

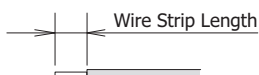



### ● Cautions for using the FT1J connected to a personal computer

When connecting the FT1J to a personal computer via the USB Interfaces, the FT1J or the personal computer may break down depending on the conditions of the personal computer. Make sure of the following cautions, in order to prevent an accident.

- If the personal computer has a 3-pin power plug or power plug with a ground lead type, make sure to use a plug socket including a ground input electrode or ground the earth lead, respectively.
- If the personal computer has a 2-pin power plug without ground lead, follow the procedure below when connect the FT1J to the personal computer.
  - (1) Pull out the power plug of the personal computer from the AC outlet.
  - (2) Connect the FT1J to the personal computer.
  - (3) Insert the power plug of the personal computer into the AC outlet.

### ● Recommended Tools

Tool Name		Model Number (Order Number)	Manufacturer
Flat blade screwdriver	Normal type	SDS 0.4×2.5×75 (9009030000)	Weidmüller
	With insulated cover	S3TL-D04-25-75	IDEC
		SDIS 0.4×2.5×75 (9008370000)	Weidmüller
Crimping tool		S3TL-CR04T S3TL-CR06D	IDEC
		PZ6/5 (9011460000)	Weidmüller
Stripping tool		S3TL-ST06	IDEC
		STRIPAX(9005000000)	Weidmüller

## 2.9 Maintenance and Inspection

Maintain and inspect the FT1J periodically to ensure the best performance. Do not disassemble, repair, or modify the FT1J during inspection.

Maintenance and Inspection Parts	Description
Display	Wipe any stain of the display using a soft cloth slightly dampened with neutral detergent or alcoholic solvent. Do not use solvents such as thinner, ammonia, strong acid, and strong alkaline.
Terminals, Connectors	Check the terminals and connectors to make sure of no loose screws, incomplete insertion, or disconnected lines.
Mounting Clips	Make sure that all mounting clips and screws are tightened sufficiently. If the mounting clips are loose, tighten the screw to the specified torque.
Backlight	The FT1J's backlight cannot be replaced by the customer. When the backlight needs to be replaced. Contact your vendor or IDEC Corporation.

## ● Maintenance Screen

When the following operation is performed during operation, the Maintenance Screen appears on the screen.

- Press the upper-left corner of the FT1J screen for three seconds or more.

If the Base Screen is switched before three seconds have elapsed, the load operation for the maintenance screen will be canceled. Please press it again.

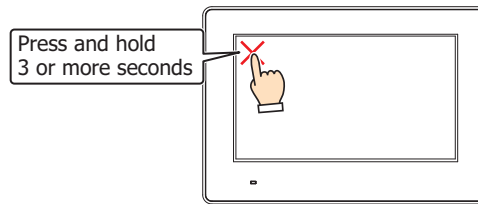

- Press the RESET switch on the back of the FT1J three times with a fine-tipped object.

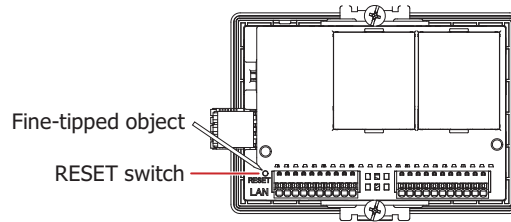

- The Maintenance Screen is not displayed in the **System Mode**.
- To display the maintenance screen, select the Enable Maintenance check box under the System tab in the Project Settings dialog box. For details, refer to Chapter 4 "3.1 System Tab" in the WindO/I-NV4 User's Manual.
- Do not touch the screen of the FT1J when operating the RESET switch.

## ● System Mode

In the System Mode, the FT1J can be changed to its initial settings and data can be initialized.

Press the **System Mode** at the top of the Maintenance Screen. The Top Page Screen appears.

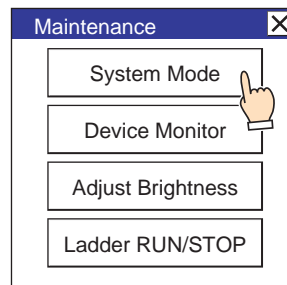

### ● Adjusting the Brightness

The brightness of the FT1J display can be adjusted on the Adjust Brightness Screen.

- 1 Press the **Adjust Brightness** at the bottom of the Maintenance Screen. The Adjust Brightness Screen appears.

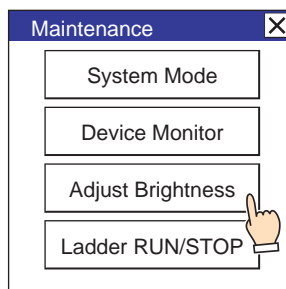

- 2 Press the << and >> at the bottom the Adjust Brightness Screen to adjust the contrast to the optimal setting.

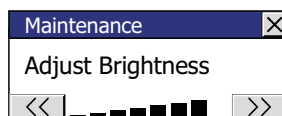

- 3 Press the **X** to close the Adjust Brightness Screen.



To adjust the brightness in the System Mode, use the << and >> buttons located at the bottom of the Top Page.

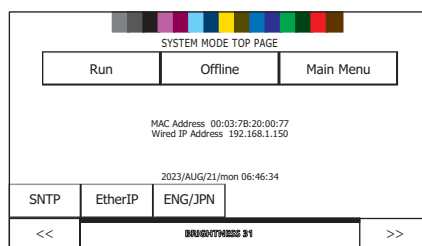

### ● Ladder RUN/STOP

Switch the ladder program between RUN and STOP by manipulating the value of the special internal relay M8000. While the ladder program is STOP, the words "Ladder STOP" flashes at the bottom right of the screen.

## 2.10 Software License Information

This product contains various open source software in addition to the software owned by IDEC Corporation. Information about open source software can be obtained from the QR code printed on the back of the FT1J.



## 1 Digital I/O Cartridge

Digital I/O cartridges are used to expand the digital inputs or digital outputs.

To use a digital I/O cartridge, it must be configured in the Module Configuration Editor. For the configuration procedure, refer to Chapter 4 "Module Configuration Editor" on page 4-1.

### 1.1 Packing Content

Before installing the FT2J/1J, make sure that the model you have received is what you actually ordered, and no parts are damaged to accidents during shipping.

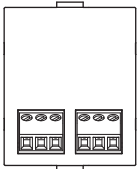
Product Name & Dimensions	Quantity	Description
Digital I/O cartridge 	1	Cartridge
Instruction Sheet	1	Japanese, English

### 1.2 Type Number

Cartridge Type	I/O Points	Type	Type Number
Digital Input	Input: 4	DC input (shared sink/source)	FC6A-PN4
Digital Output	Output: 4	Transistor sink output	FC6A-PTK4
		Transistor source output	FC6A-PTS4

### 1.3 Part Names

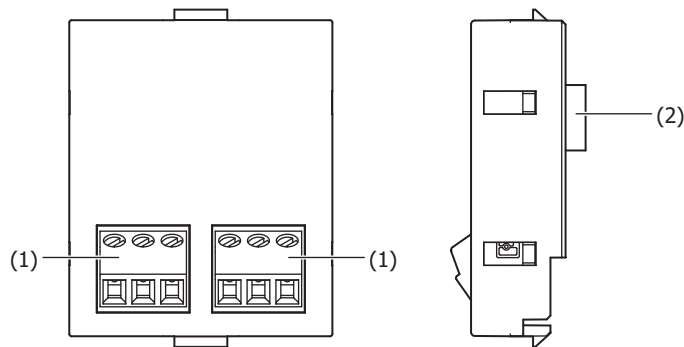

No.	Name	Description
(1)	Terminals	These terminals connect the cartridge to the power supply and to input or output devices.
(2)	Connector	This connector connects the cartridge to Cartridge Slot of the FT2J/1J.

## 1.4 Specifications

### ■ Environmental Specifications

Type Number	FC6A-PN4	FC6A-PTK4	PC6A-PTS4
Ambient Operating Temperature	-10 to +55°C (no freezing)		
Ambient Operating Humidity	10 to 95% RH (no condensation)		
Ambient Storage Temperature	-25 to +70°C (no freezing)		
Ambient Storage Humidity	10 to 95% RH (no condensation)		
Altitude	0 to 2,000 m (1,013 to 795hPa) during operation 0 to 3,000 m (1,013 to 701hPa) during transport		

### ■ Construction Specifications

Type Number	FC6A-PN4	FC6A-PTK4	PC6A-PTS4
Vibration Resistance	5 to 8.4 Hz half amplitude 3.5 mm, 8.4 to 150 Hz, acceleration 9.8 m/s <sup>2</sup> (1 G), each direction XYZ, 2 hours		
Shock Resistance	147 m/s <sup>2</sup> (15 G), 11 ms, XYZ, 3 axes, 6 directions, 3 times each		

### ■ Function Specifications

Type Number	FC6A-PN4	FC6A-PTK4	PC6A-PTS4
Rated Voltage	5.0 V, 3.3 V (supplied from main unit)		
Current Draw	5.0 V: 0 mA 3.3 V: 35 mA		
Weight	15 g		

### ■ Digital Input Specifications

Type Number	FC6A-PN4		
Rated Input Voltage	12/24V DC (shared sink/source)		
Operating Input Voltage Range	0 to 28.8V DC		
Rated Input Current	5 mA/1 point (when 24V DC) 2.5 mA/1 point (when 12V DC)		
Terminal Arrangement	Refer to "Terminal Arrangement and Wiring Examples" on page 2-6.		
Input Impedance	4.4 kΩ		
Input Delay Time (24V DC)	Turn ON Time	0.5 ms	
	Turn OFF Time	0.5 ms	
Input Type	Type 1 (IEC 61131-2)		
External Load for I/O Interconnection	Not isolated		
Signal Determination Method	Static		
Effect of Improper Input Connection	No damage However, if high voltage is applied that exceeds the operating input voltage range, there is a risk of permanent damage.		
Cable Length in compliance with electromagnetic immunity	3 m		

### Operating Ranges

The operating range of Type 1 (IEC 61131-2) DC input modules is as follows.

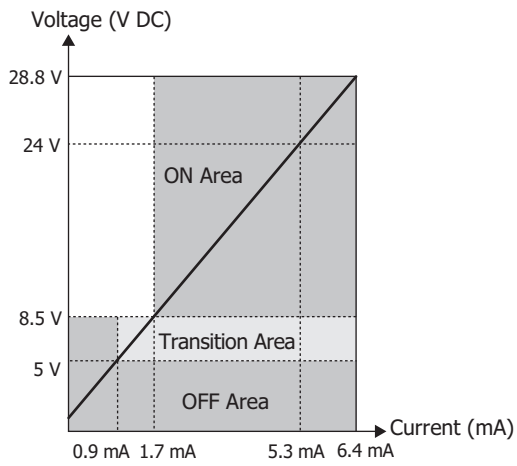

### Input Equivalent Circuit

#### **FC6A-PN4**

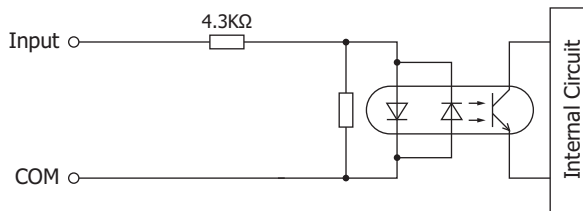

### ■ Digital Output Specifications

Type Number	FC6A-PTK4	FC6A-PTS4
Output Circuit Type	Transistor sink output	Transistor source output
Output Points	4 (4 points in 1 common line)	
Rated Load Voltage	12/24V DC	
Operating Input Voltage Range	10.2 to 28.8V DC	
Rated Load	0.1 A/1 point	
Terminal Arrangement	Refer to "Terminal Arrangement and Wiring Examples" on page 2-6.	
Voltage Drop (ON Voltage)	0.4 V or less, voltage between COM and output terminal when ON	
Allowed Inrush Current	1 A maximum	
Leakage Current	0.1 mA maximum	
Clamping Voltage	50 V	
Lamp Load	2.4 W maximum	
Inductive Load	L/R = 10 ms (28.8V DC, 1 Hz)	
Protection Operation	None	
External Current Draw	100 mA maximum, 24V DC (+V terminal supply power)	
Output Delay Time (24V DC)	Turn ON Time	450 $\mu$ s maximum
	Turn OFF Time	450 $\mu$ s maximum

#### Output Equivalent Circuit

**FC6A-PTK4**

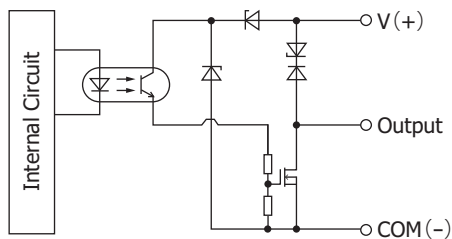

**FC6A-PTS4**

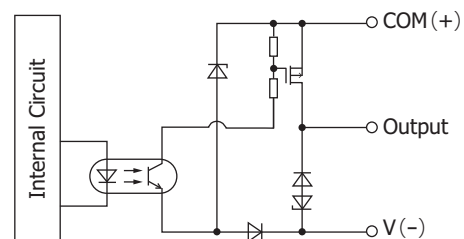



## 1.5 Dimensions

Unit: mm

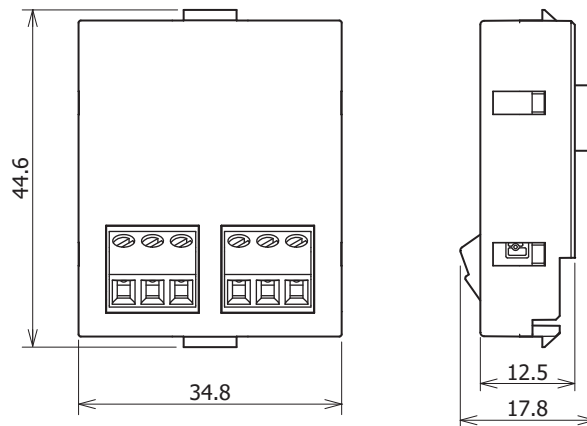

## 1.6 Install and remove

- 1 Insert two flathead screwdrivers into the screwdriver insertion slots in both locations of the main unit, and while pushing the tabs of the dummy cartridge, remove the dummy cartridge straight off of the main unit.

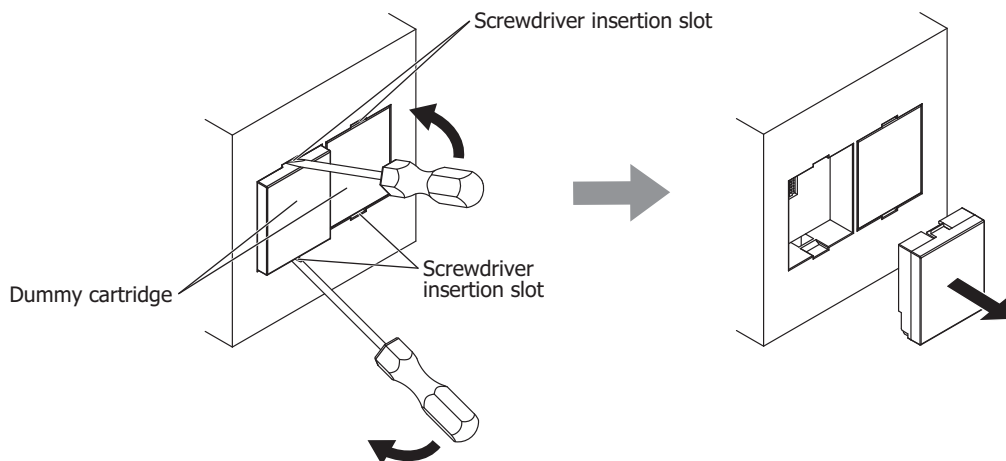

- 2 Pay careful attention to the direction of the cartridge and attach it directly onto the main unit.

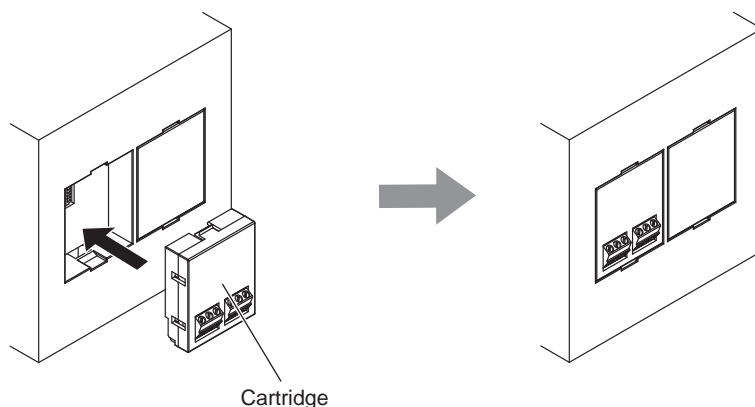

To remove the cartridge, perform the work detailed in step 1.



- Always install and remove the cartridges when the power is turned off.
- Attach the cartridge directly onto the unit. If the cartridge is attached when tilted, it may be damaged or cause communication problems.
- When not using cartridge, attach the dummy cartridge.

## 1.7 Wiring

### ⚠ CAUTION

- When connecting cables to the cartridges, the tightening torque is 0.2 N·m.
- Insert a fuse that corresponds to the load.

#### ● Terminal Arrangement and Wiring Examples

##### Digital Input

###### FC6A-PN4

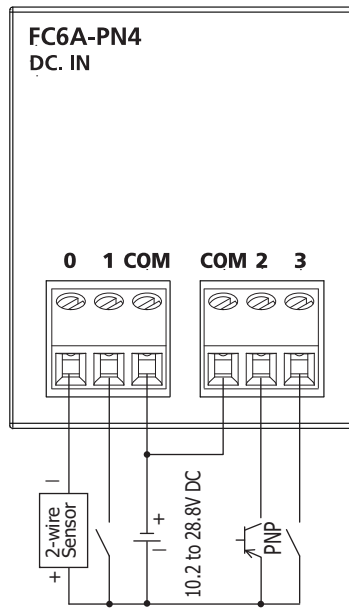
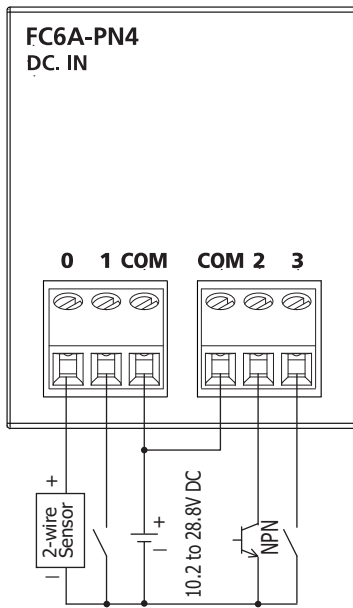

Ⓛ : Load  
 : Fuse

##### Digital Output

###### FC6A-PTK4

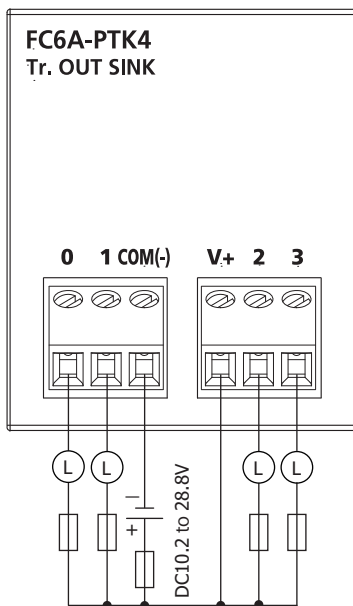

Ⓛ : Load  
 : Fuse

###### FC6A-PTS4

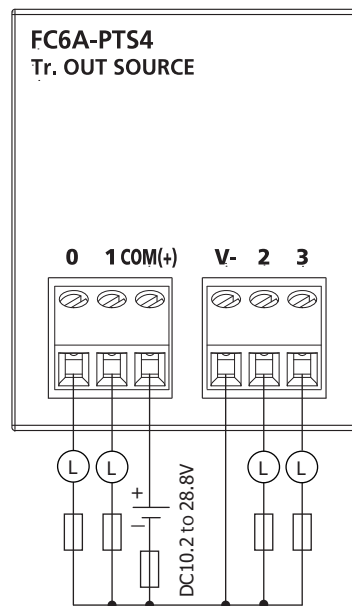

Ⓛ : Load  
 : Fuse

## 2 Analog I/O Cartridge

Analog I/O cartridges are used to expand the analog inputs or analog outputs.

The analog data and analog status of the analog I/O cartridge is stored in special data registers. For details, refer to Chapter 4 "Data" on page 4-9.

To use an analog I/O cartridge, it must be configured in the Module Configuration Editor. For the configuration procedure, refer to Chapter 4 "Module Configuration Editor" on page 4-1 and Chapter 4 "4.2 Parameter Settings" on page 4-7.

### 2.1 Packing Content

Before installing the FT2J/1J, make sure that the model you have received is what you actually ordered, and no parts are damaged to accidents during shipping.

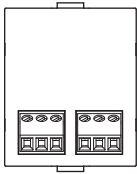
Product Name & Dimensions	Quantity	Description
Analog I/O Cartridge 	1	Cartridge
Instruction Sheet	1	Japanese, English

### 2.2 Type Number

Cartridge Type	I/O Points	Signal Type	Type Number
Analog input	Input: 2	Voltage input: 0 to 10 V	FC6A-PJ2A
		Current input: 0 to 20 mA, 4 to 20 mA	
		Thermocouple input: K type, J type, R type, S type, B type, E type, T type, N type, C type	FC6A-PJ2CP
		Resistance thermometer input: Pt100, Pt1000, Ni100, Ni1000	
Analog output	Output: 2	Voltage output: 0 to 10 V	FC6A-PK2AV
		Current output: 4 to 20 mA	FC6A-PK2AW

### 2.3 Part Names

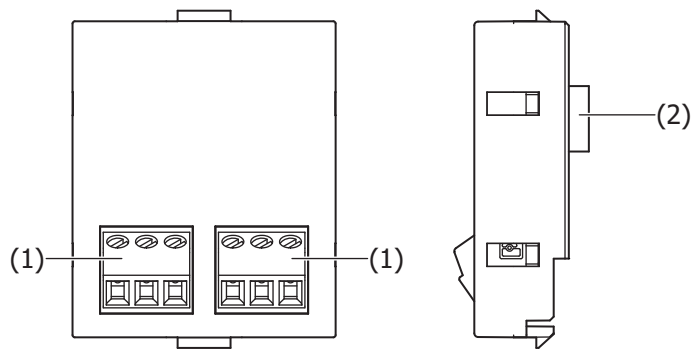

No.	Name	Description
(1)	Terminals	These terminals connect the cartridge to the power supply and to input or output devices.
(2)	Connector	This connector connects the cartridge to Cartridge Slot of the FT2J/1J.

● Description Location of Version Number

The analog I/O cartridge version number is printed on the side of the analog I/O cartridge in the location in the following diagram.

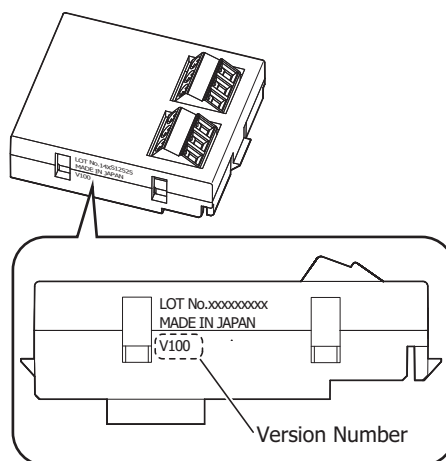

## 2.4 Specifications

### ■ Environmental Specifications

Type Number	FC6A-PJ2A	FC6A-PJ2CP	FC6A-PK2AV	FC6A-PK2AW
Ambient Operating Temperature	-10 to +55°C (no freezing)			
Ambient Operating Humidity	10 to 95% RH (no condensation)			
Ambient Storage Temperature	-25 to +70°C (no freezing)			
Ambient Storage Humidity	10 to 95% RH (no condensation)			
Altitude	0 to 2,000 m (1,013 to 795hPa) during operation 0 to 3,000 m (1,013 to 701hPa) during transport			

### ■ Construction Specifications

Type Number	FC6A-PJ2A	FC6A-PJ2CP	FC6A-PK2AV	FC6A-PK2AW
Vibration Resistance	5 to 8.4 Hz half amplitude 3.5 mm, 8.4 to 150 Hz, acceleration 9.8 m/s <sup>2</sup> (1 G), each direction XYZ, 2 hours			
Shock Resistance	147 m/s <sup>2</sup> (15 G), 11 ms, XYZ, 3 axes, 6 directions, 3 times each			

### ■ Function Specifications

Type Number	FC6A-PJ2A	FC6A-PJ2CP	FC6A-PK2AV	FC6A-PK2AW
Rated Voltage	5.0 V, 3.3 V (supplied from main unit)			
Current Draw	5.0 V: - 3.3 V: 30 mA		5.0 V: 70 mA 3.3 V: 30 mA	5.0 V: 185 mA 3.3 V: 30 mA
Weight	15 g			

■ Analog Input Specifications

Type Number		FC6A-PJ2A		FC6A-PJ2CP	
Input Electrical Characteristic*1		Voltage	Current	Thermocouple	Resistance thermometer
Input Range		0 to 10 V	4 to 20 mA 0 to 20 mA	K type: -200 to +1300 °C (-328 to +2372 °F) J type: -200 to +1000 °C (-328 to +1832 °F) R type: 0 to 1760 °C (32 to 3200 °F) S type: 0 to 1760 °C (32 to 3200 °F) B type: 0 to 1820 °C (32 to 3308 °F) E type: -200 to +800 °C (-328 to +1472 °F) T type: -200 to +400 °C (-328 to +752 °F) N type: -200 to +1300 °C (-328 to +2372 °F) C type: 0 to 2315 °C (32 to 4199 °F)	Pt100: -200 to +850 °C (-328 to 1562 °F) Pt1000: -200 to +600 °C (-328 to 1112 °F) Ni100: -60 to +180 °C (-76 to 356 °F) Ni1000: -60 to +180 °C (-76 to 356 °F)
Input Impedance		1 mΩ min.	250 Ω max.	1 mΩ min.	
Allowable Conductor Resistance		-	-	-	10 Ω max.
Input Detection Current		-	-	-	1.0 mA max. (TYP: 0.2 mA)
AD Conversion	Sampling time	10 ms		250 ms	
	Sampling Repetition Time	20 ms		500 ms	
	Total Input Delay Time*2	Sampling time + Sampling repetition time + 1 scan time			
	Type of Input	Single-ended			
	Signal Type	Self-scan			
	Conversion Method	SAR			
Input Error	Maximum Error at 25°C	±0.1% of full scale		±0.1% of full scale Cold junction compensation accuracy ±4.0°C or less  Exceptions R type, S type thermocouple error: ±6.0°C (0 to 200°C range only) B type thermocouple error: Not guaranteed (0 to 300°C range only) K type, J type, E type, T type, N type thermocouple error: ±0.4% FS (0°C or lower range only)	±0.1% of full scale
	Temperature Coefficient	±0.02%/°C of full scale			

\*1 Can be set by application software.

\*2 The total input delay time increases in proportion to the number of channels used.

Type Number		FC6A-PJ2A		FC6A-PJ2CP	
Input Electrical Characteristic* <sup>1</sup>		Voltage	Current	Thermocouple	Resistance thermometer
Data	Digital Resolution	4,096 increments (12bit)		K type: 15000 (14bit) J type: 12000 (14bit) R type: 17600 (15bit) S type: 17600 (15bit) B type: 18200 (15bit) E type: 10000 (14bit) T type: 6000 (13bit) N type: 15000 (14bit) C type: 23150 (15bit)	Pt100: 10500 (14bit) Pt1000: 8000 (13bit) Ni100: 2400 (12bit) Ni1000: 2400 (12bit)
	Input Value per Step	2.44 mV (0 to 10 V)	4.88 $\mu$ A (0 to 20 mA) 3.91 $\mu$ A (4 to 20 mA)	0.1°C 0.18°F	
	Data Type* <sup>3</sup>	Can be set for each channel. Binary data: 0 to 4095 Optional range* <sup>3</sup> : -32768 to 32767			
	Monotonicity	Yes			
	Input Data Out of Range	Detectable* <sup>4</sup>			
Noise Resistance	Recommended cable	Pair shielded cable		Pair cable	
	Crosstalk	1 LSB max.			
Isolation		None			
Effect When Input is Incorrectly Wired		No Damage			
Maximum Permanent Allowed Overload (No damage)* <sup>5</sup>		13 V	40 mA	13 V	
Calibration to Maintain Rated Accuracy		Not possible			

\*1 Can be set by application software.

\*3 This function converts analog value within a specified range and uses it.

Example: When the digital resolution is 12 bits and the input range is -10 to +10 V, -5V input is displayed as 1024 for the analog value. However, if the Min. is set to -1000 and the Max. is set to 1000 for Optional range, -500 is treated as an input value.

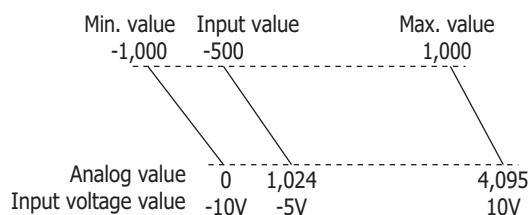

\*4 Input data out of range is reflected in the status of the analog I/O cartridge.

\*5 The maximum voltage or current value that can be input without damage.

Input Equivalent Circuit

**FC6A-PJ2A**

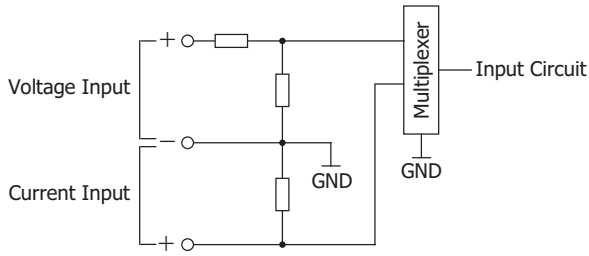

**FC6A-PJ2CP**

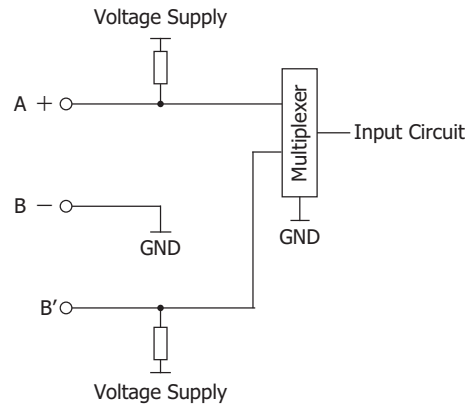

■ **Analog Output Specifications**

Type Number		FC6A-PK2AV	FC6A-PK2AW
Output Electrical Characteristic		Voltage	Current
Output Range		0 to 10 V	4 to 20 mA
Output Load	Impedance	2 kΩ or higher	500 Ω or lower
	Load Type	Resistive load	
DA Conversion	DA Conversion Time	40 ms maximum	20 ms maximum
	Output Update Interval	20 ms	
	Total Output System Transfer Time	DA conversion time + Output Update Interval + 1 scan time	
Output Error	Maximum Error at 25°C	±0.3% of full scale	
	Temperature Coefficient	±0.02%/°C of full scale	
	Output Ripple	30 mV max.	
	Overshoot	0%	
Data	Digital Resolution	4,096 increments (12bit)	
	Output Value per Step	2.44 mV (0 to 10 V)	3.91 μA (4 to 20 mA)
	Data Type in Application	0 to 4095 (0 to 10 V)	0 to 4095 (4 to 20 mA)
	Monotonicity	Yes	
	Current Loop Open	-	Not detectable
Noise Resistance	Maximum Temporary Deviation during Electrical Noise Tests	±4.0% of full scale max.	
	Recommended Cable	Pair shielded cable	
	Crosstalk	1 LSB max.	
Isolation		None	
Effect of Improper Output Connection		No damage	
Calibration to Maintain Rated Accuracy		Not possible	

Output Equivalent Circuit

**FC6A-PK2AV, FC6A-PK2AW**

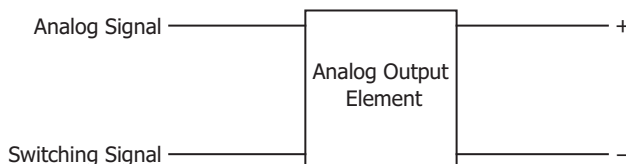



## 2.5 Dimensions

Unit: mm

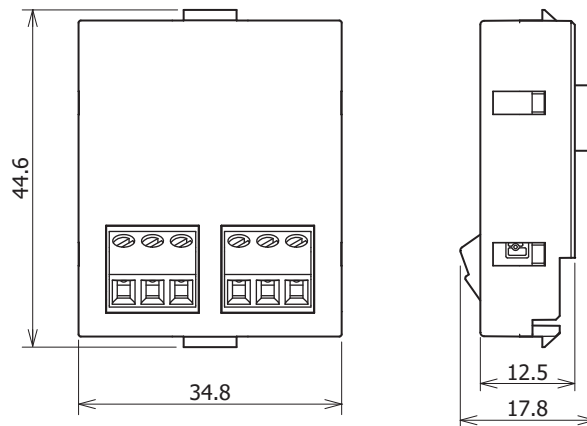

## 2.6 Install and remove

- 1 Insert two flathead screwdrivers into the screwdriver insertion slots in both locations of the main unit, and while pushing the tabs of the dummy cartridge, remove the dummy cartridge straight off of the main unit.

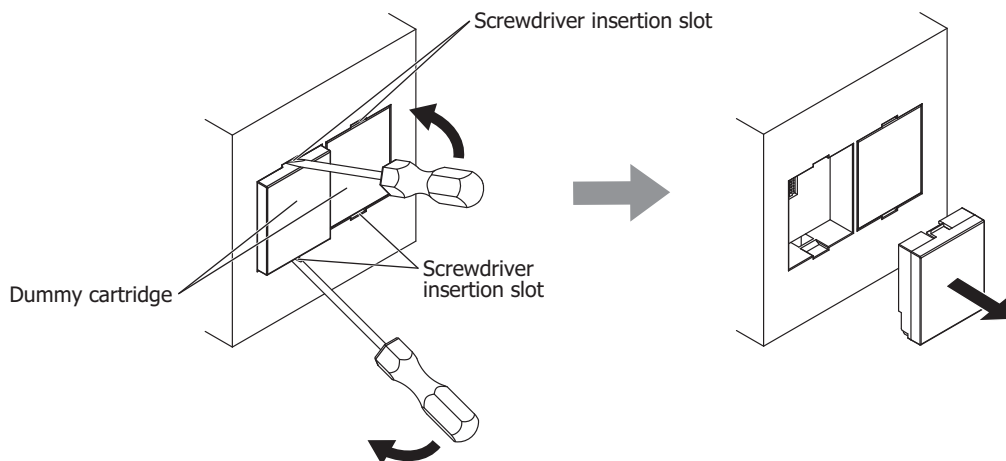

- 2 Pay careful attention to the direction of the cartridge and attach it directly onto the main unit.

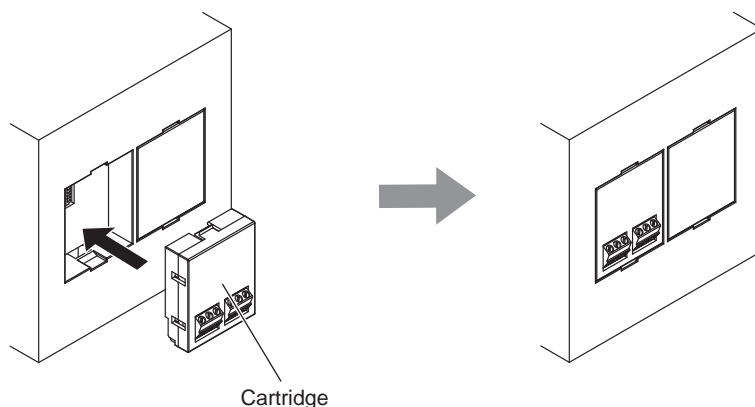

To remove the cartridge, perform the work detailed in step 1.



- Always install and remove the cartridges when the power is turned off.
- Attach the cartridge directly onto the unit. If the cartridge is attached when tilted, it may be damaged or cause communication problems.
- When not using cartridge, attach the dummy cartridge.

## 2.7 Wiring

### ⚠ CAUTION

- Do not connect a thermocouple to a hazardous voltage component (60V DC or peak 42.4 V or higher component).  
Always check the wiring before turning on the power. If the wiring is incorrect, the analog I/O cartridge may be damaged. When there is a risk of malfunction due to noise, use a shielded cable for the wiring and connect both ends of the shield to the FG.
- When connecting cables to the cartridges, the tightening torque is 0.2 N·m.

#### ● Terminal Arrangement and Wiring Examples

##### Analog Input

###### FC6A-PJ2A

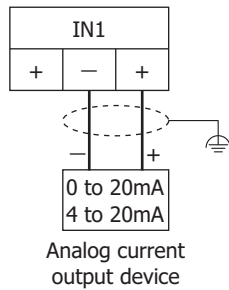
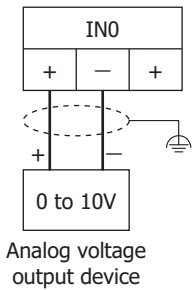

###### FC6A-PJ2CP

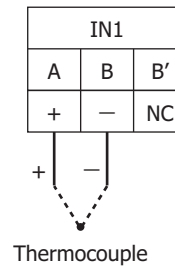
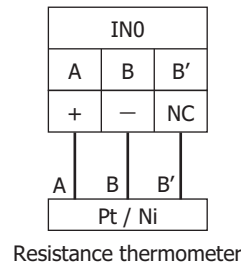

##### Analog Output

###### FC6A-PK2AV

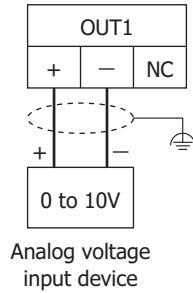
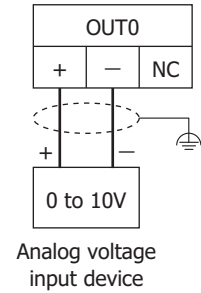

###### FC6A-PK2AW

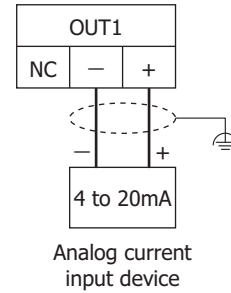
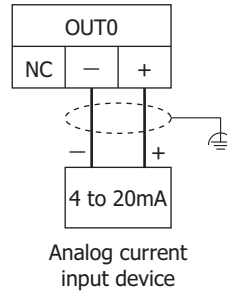

## 1 Optional items

### 1.1 FT2J

Name	Type Number	Description
USB Panel-Mount Extension Cable	HG9Z-XCE11	Extension cable for attaching to USB interface (Type-A) Length: 1m
PLC Connection Cable	FC2A-KP1C	Connection cable for Serial interface (COM) (Compatible models: IDEC FC5A/4A MICROSmart) Length: 2.4m <Connector> Main unit: Parted wire External device: Mini DIN 8-pin
	HG9Z-XC275	Connection cable for Serial interface (COM) (Compatible models: IDEC FC5A/4A MICROSmart) Length: 5m <Connector> Main unit: Parted wire External device: Mini DIN 8-pin
	FC6A-KC1C	Connection cable for Serial interface (COM) (Compatible models: IDEC F6A MICROSmart FC6A-C*****E only) Length: 5m <Connector> Main unit: Parted wire External device: RJ45
Surface Protection Film <sup>*1</sup>	HG9Z-2D7PN05	5 pcs/pack
UV Surface Protection Film <sup>*2</sup>	FT9Z-2D7PN05	5 pcs/pack

\*1 No UV resistant.

\*2 The protective sheet is UV resistant, however, resistance against direct sunlight in outdoor usage is not guaranteed.

## 1.2 FT1J

Name	Type Number	Description
USB Panel-Mount Extension Cable	HG9Z-XCE11	Extension cable for attaching to USB interface (Type-A) Length: 1m
PLC Connection Cable	FC2A-KP1C	Connection cable for Serial interface (COM) (Compatible models: IDEC FC5A/4A MICROSmart) Length: 2.4m <Connector> Main unit: Parted wire External device: Mini DIN 8-pin
	HG9Z-XC275	Connection cable for Serial interface (COM) (Compatible models: IDEC FC5A/4A MICROSmart) Length: 5m <Connector> Main unit: Parted wire External device: Mini DIN 8-pin
	FC6A-KC1C	Connection cable for Serial interface (COM) (Compatible models: IDEC F6A MICROSmart FC6A-C*****E only) Length: 5m <Connector> Main unit: Parted wire External device: RJ45
Surface Protection Film*1	HG9Z-1E4PN05	5 pcs/pack
UV Surface Protection Film*2	FT9Z-1E4PN05	5 pcs/pack
Power Supply Terminal Connector	FT9Z-1X03V	Terminal Block 3-pin (Right angle type, Push-in type) Applicable cable: AWG12 to 26 Conductor type: Solid wire or Stranded wire Wire strip length: 12 to 13 mm Recommended ferrule: S3TL-H025-12WJ, S3TL-H034-12WT, S3TL-H05-14WA, S3TL-H075-14WW (IDEC) H0,25/12 HBL, H0,34/12 TK, H0,5/14 OR, H0,75/14 W (Weidmüller) AI 0,25-8YE, AI 0,34-8TQ, AI 0,5-8WH, AI 0,75-8GY (Phoenix Contact)
Input Terminal Connector*3	FT9Z-XT10V	Terminal Block 10-pin (Right angle type, Screw type) Applicable cable: AWG14 to 28 Conductor type: Solid wire or Stranded wire Wire strip length: 6 to 7 mm Recommended ferrule: S3TL-H025-12WJ, S3TL-H034-12WT, S3TL-H05-14WA (IDEC) H0,25/12 HBL, H0,34/12 TK, H0,5/14 OR (Weidmüller) AI 0,25-8YE, AI 0,34-8TQ, AI 0,5-8WH (Phoenix Contact)
Output Terminal Connector*3	FT9Z-XT11V	Terminal Block 11-pin (Right angle type, Screw type) Applicable cable: AWG14 to 28 Conductor type: Solid wire or Stranded wire Wire strip length: 6 to 7 mm Recommended ferrule: S3TL-H025-12WJ, S3TL-H034-12WT, S3TL-H05-14WA (IDEC) H0,25/12 HBL, H0,34/12 TK, H0,5/14 OR (Weidmüller) AI 0,25-8YE, AI 0,34-8TQ, AI 0,5-8WH (Phoenix Contact)

\*1 No UV resistant.

\*2 The protective sheet is UV resistant, however, resistance against direct sunlight in outdoor usage is not guaranteed.

\*3 When using this connector, the main unit is not applicable with UL certification. In addition, use applicable cables and recommended ferrules shown in the table for wiring to each terminal.

## 2 Replacement Parts

### 2.1 FT2J

Name	Type Number	Quantity	Description
Mounting clips	HG9Z-4K2PN04	4	-
Serial interface connector	HG9Z-XT09P	1	Terminal Block 9-pin (Vertical type, Push-in type)
Input terminal connector	FT9Z-XT16P	1	Terminal Block 16-pin (Vertical type, Push-in type)
Output terminal connector	FT9Z-XT11P	1	Terminal Block 11-pin (Vertical type, Push-in type)

### 2.2 FT1J

Name	Type Number	Quantity	Description
Mounting clips	HG9Z-4K2PN04	4	-
Power supply terminal connector	FT9Z-1X03P	1	Terminal Block 3-pin (Vertical type, Push-in type)
Serial interface connector	FT9Z-1T10P	1	Terminal Block 10-pin (Vertical type, Push-in type)
Input terminal connector	FT9Z-XT10P	1	Terminal Block 10-pin (Vertical type, Push-in type)
Output terminal connector	FT9Z-XT11P	1	Terminal Block 11-pin (Vertical type, Push-in type)



# Chapter 4 Module Configuration Editor

## 1 Overview

This chapter describes the Module Configuration Editor to configure the settings for the I/O cartridge.

### 1.1 Configuration & Functions

This section describes the names and functions that make up Module Configuration Editor.

Module configuration area: Displays the configuration of connected cartridges.

Preview Module Configuration: Previews the image of the FT2J/1J and I/O cartridges set in the module configuration area. Click this button to display the Preview Module Configuration dialog box.

Cartridges List: Displays a list of cartridges that can be connected to the FT2J/1J.

Parameter Setting Area: Displays the parameters set for the object selected in the Module Configuration Area.

Configure: Configure each parameter of the cartridge. Click this button to display the configuration dialog box that corresponds to the cartridge.

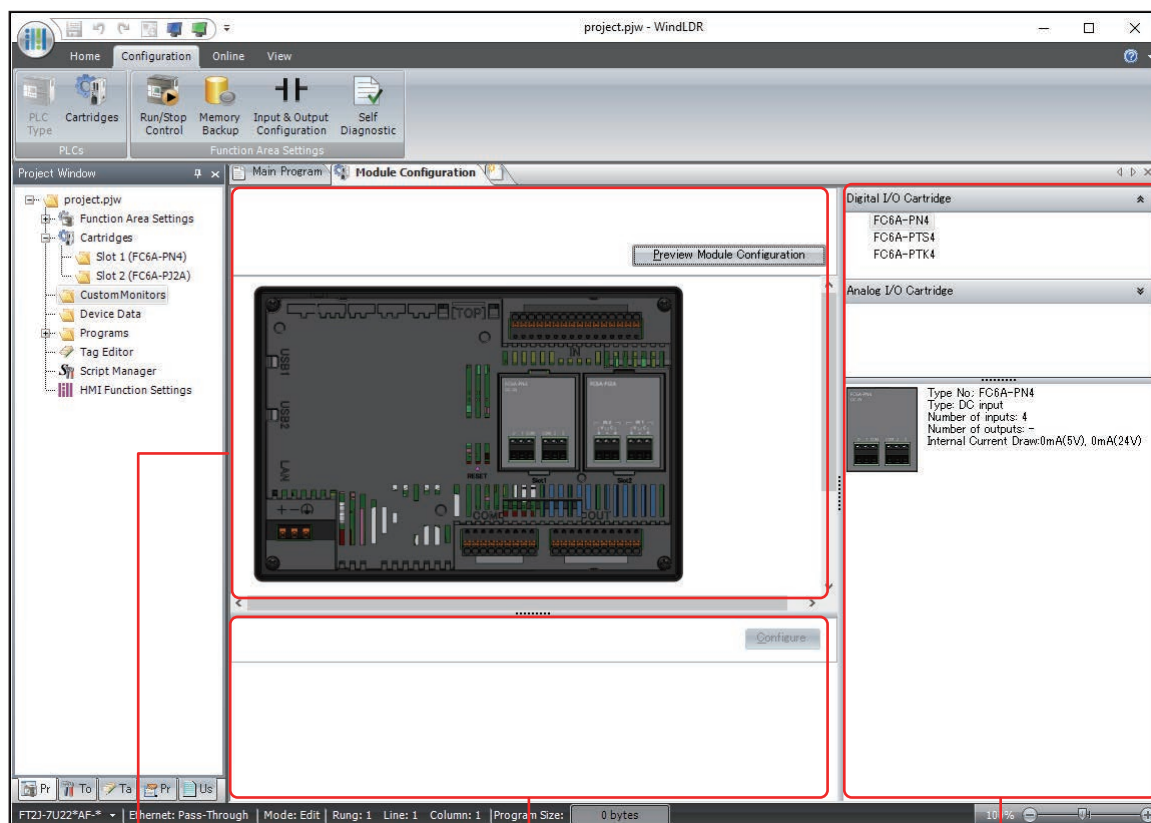

Module Configuration Area

Parameter Setting Area

Cartridges List

## 2 Basic Operations

### 2.1 Open the Module Configuration Editor

On **WindLDR**, click **Cartridges** in **PLCs** group on **Configuration** tab.

The Module Configuration Editor is displayed.



### 2.2 Inserting I/O Cartridges

- 1 Select the cartridge to insert in the Cartridges List, and then drag and drop it to the cartridge slot in the Module Configuration Area.

The cartridge is inserted into the main unit.

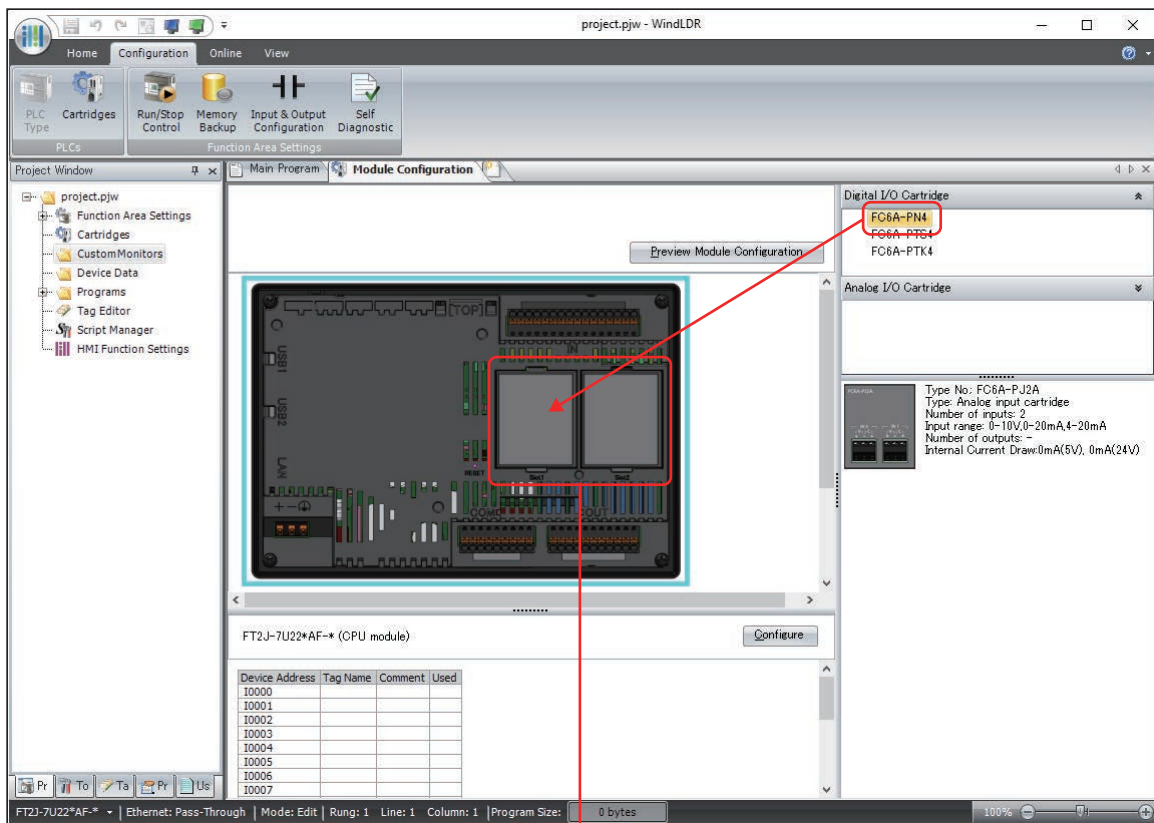

Cartridge Slot



- 2 Click the inserted cartridge, and then click **Configure** in the Parameter Setting Area.

The configuration dialog box that corresponds to the cartridge is displayed.

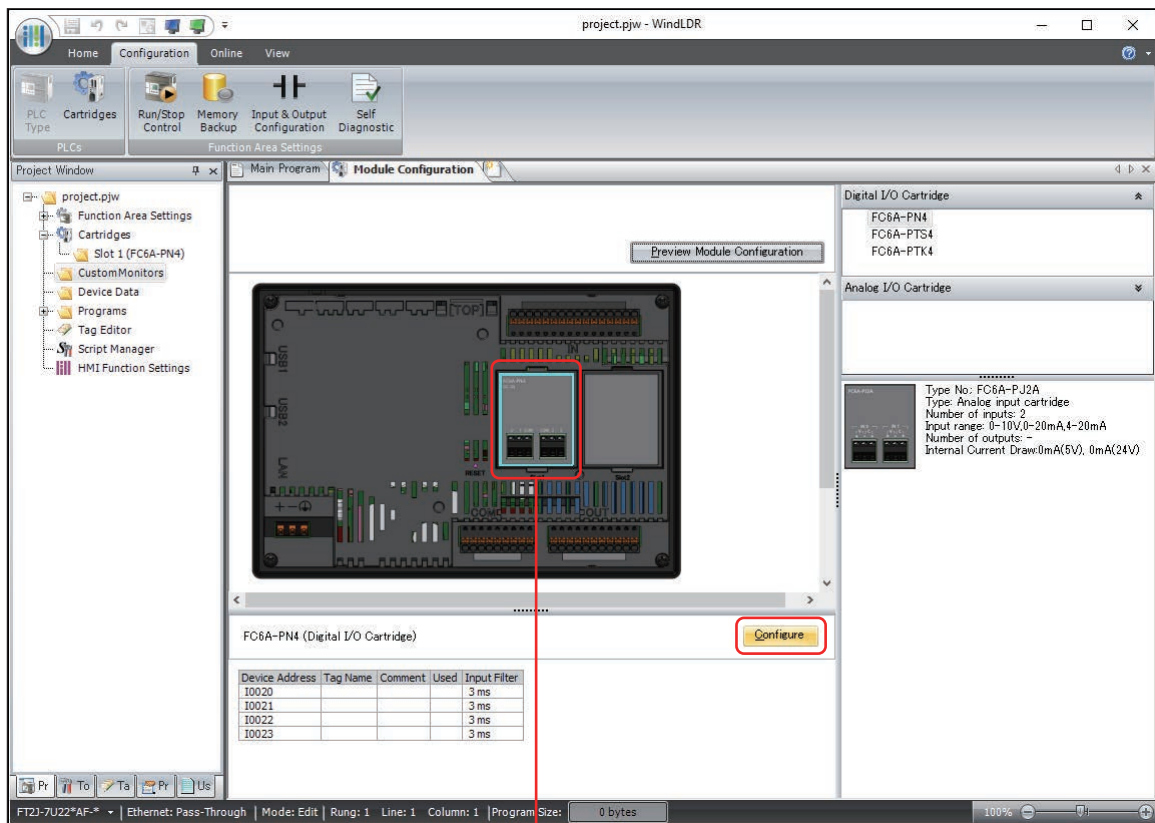

Inserted Cartridge

- 3 Configure the parameters for the cartridge in each configuration dialog box.

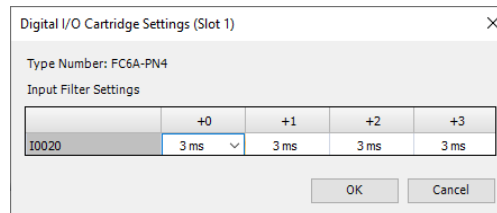

## 2.3 Deleting I/O Cartridge

- 1 Click to select the cartridge to remove in the module configuration area.

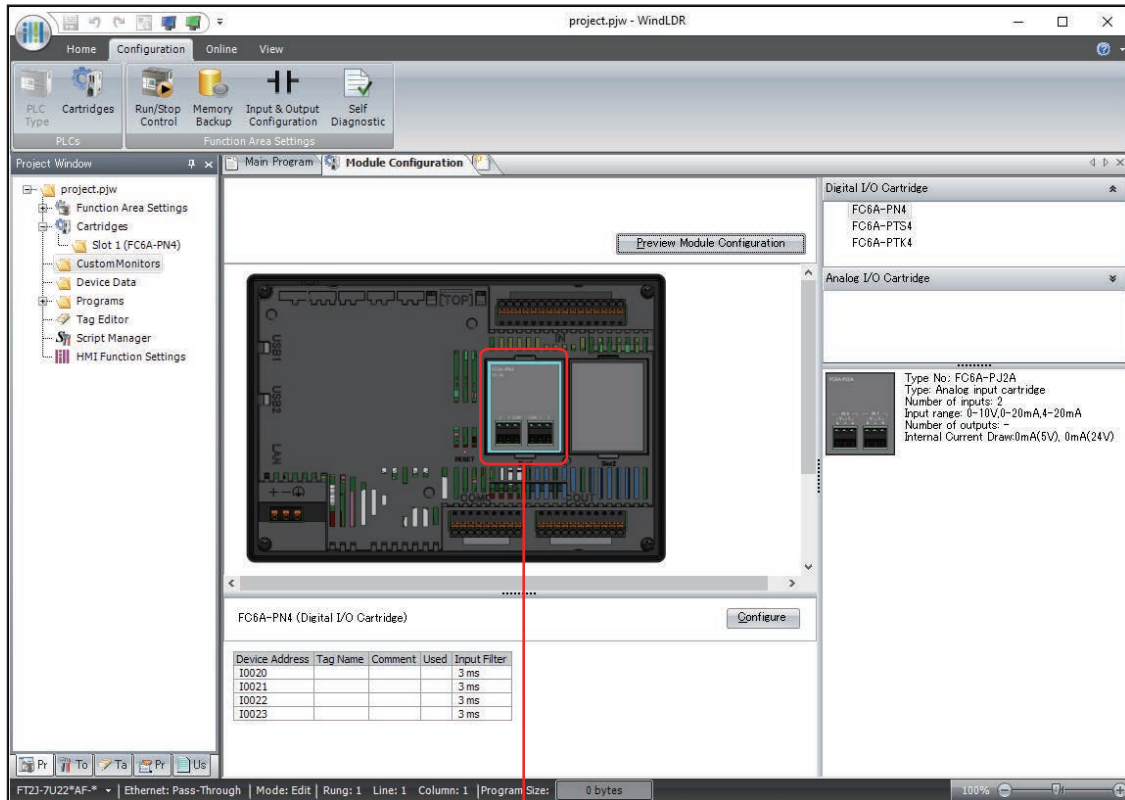

Cartridge to remove

- 2 Right-click the selected cartridge and click **Remove**.

The selected cartridge is removed.

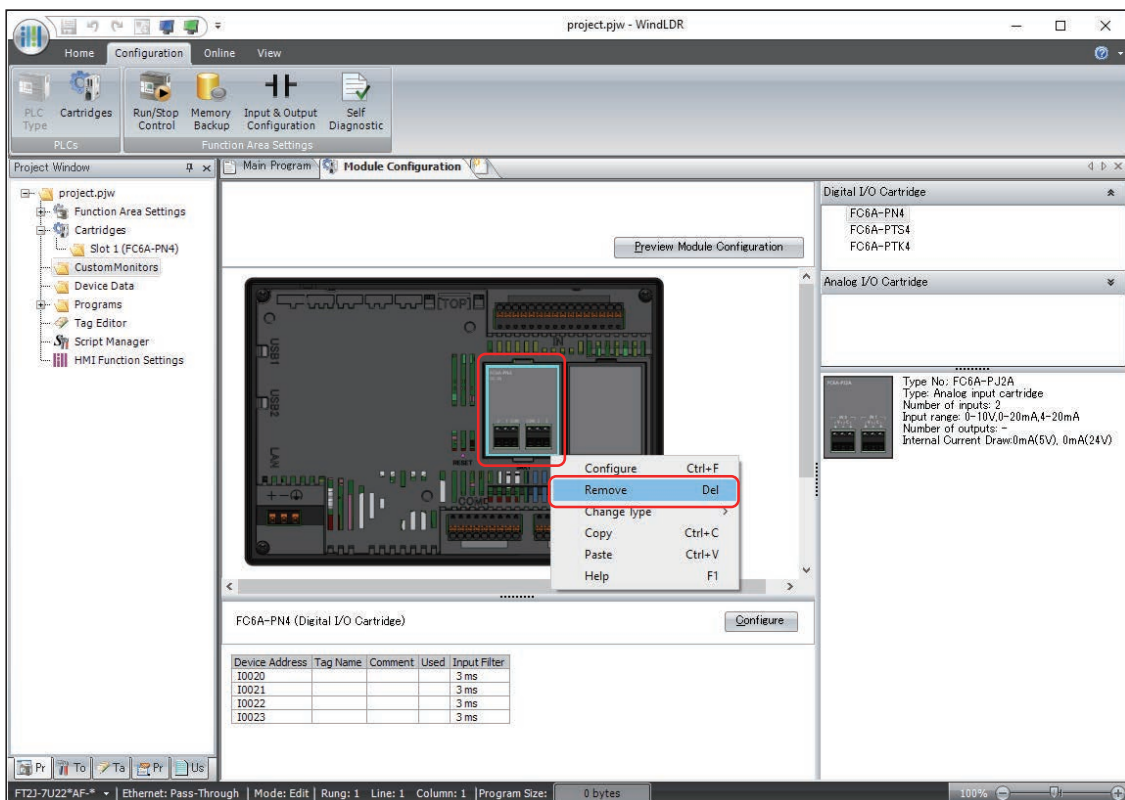

## 2.4 Changing I/O Cartridge

- 1 Select the cartridge to move in the module configuration area, and drag and drop it onto the destination.

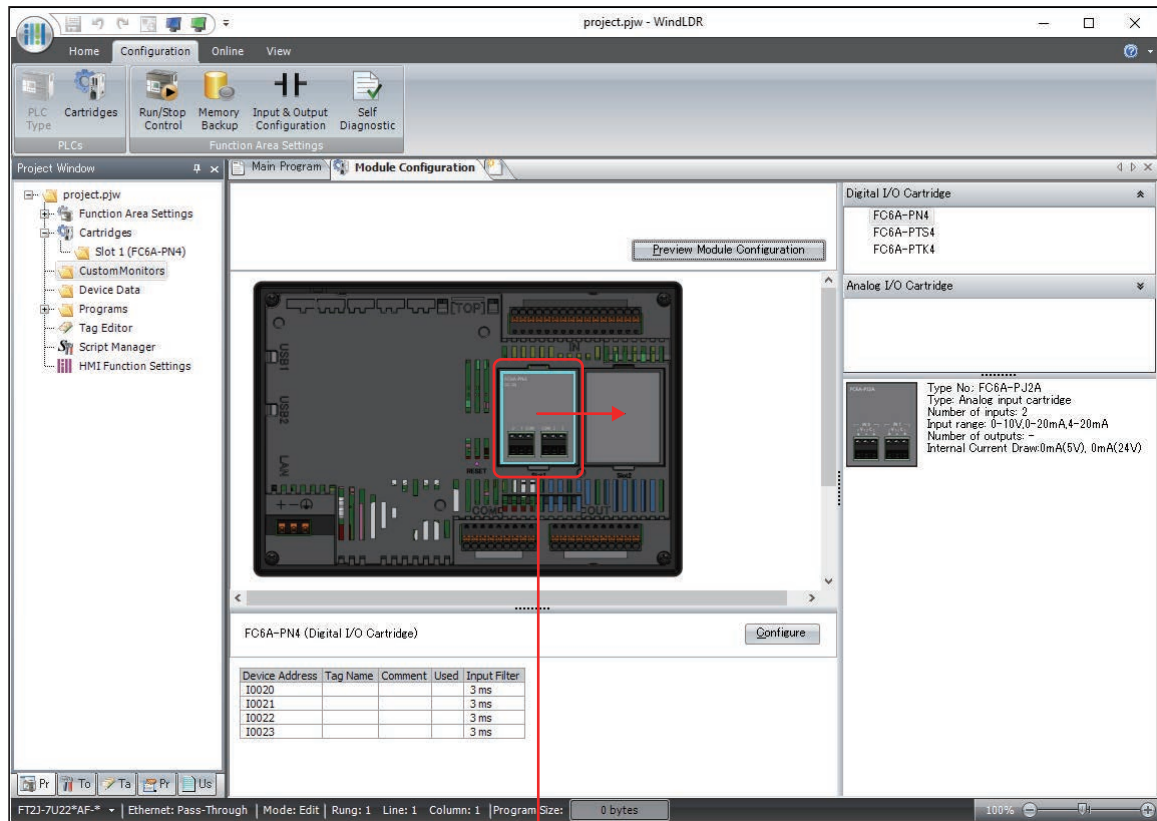

Cartridge to move



When the I/O cartridge is changed, the device addresses change according to the target slot. The device addresses in the project are not changed.

## 3 Digital I/O Cartridge Settings

### 3.1 I/O Assignments

Type	Digital Input		Digital Output	
Cartridge Slot	Slot 1	Slot 2	Slot 1	Slot 2
Device Address	I20 to I23	I24 to I27	Q10 to Q13	Q14 to Q17



I0 to I15 and Q0 to Q7 are internal devices of the FT2J/1J. For details, refer to Chapter 35 "1.2 Control Device Addresses" in the WindO/I-NV4 User's Manual.

### 3.2 Parameter Settings

To use the digital input cartridges, configure the parameters.

Configure the parameters according to your application on the Digital I/O Cartridge Settings dialog box displayed by clicking Configure in Parameter Setting Area. For details, refer to "Digital I/O Cartridge Settings dialog box".

#### ● Digital I/O Cartridge Settings dialog box



The slot number placed the cartridge being edited is displayed on the title bar.

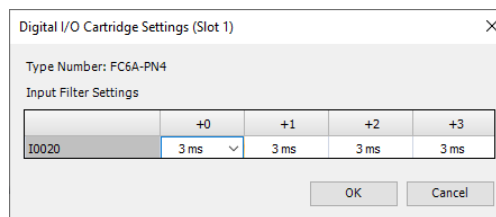

#### ■ Type Number

Displays the type number of the cartridge placed in the cartridge slot.

#### ■ Input Filter Settings

The input filter is used to adjust the filter width according to the width of the input signal in order to decrease the effects of input contact bounce and noise. For details, refer to Chapter 28 "3.12 Input Filter" in the WindO/I-NV4 User's Manual.

Specifies the filter value (0, 3 to 15) in 1 millisecond increments. However, when the value is 0, the analog input is not filtered.

## 4 Analog I/O Cartridge Settings

### 4.1 I/O Assignments

Type	Analog input				Analog output			
Cartridge Slot	Slot 1		Slot 2		Slot 1		Slot 2	
Channel	IN0	IN1	IN0	IN1	OUT0	OUT1	OUT0	OUT1
Analog Number	AI4	AI5	AI6	AI7	AQ2	AQ3	AQ4	AQ5



- AI0 to AI3 are analog inputs of the FT2J/1J. For details, refer to Chapter 28 "3.13 Analog Inputs" in the WindO/I-NV4 User's Manual.
- AQ0 and AQ1 are analog outputs of the FT2J/1J. For details, refer to Chapter 28 "3.14 Analog Outputs" in the WindO/I-NV4 User's Manual.

### 4.2 Parameter Settings

To use the analog I/O cartridges, configure the parameters.

The parameters are set for each channel. Configure the parameters according to your application on the Analog I/O Cartridge Settings dialog box displayed by clicking Configure in Parameter Setting Area. For details, refer to "Analog I/O Cartridge Settings Dialog Box".

#### ● Analog I/O Cartridge Settings Dialog Box



The slot number placed the cartridge being edited is displayed on the title bar.

(Parameter Setting List)

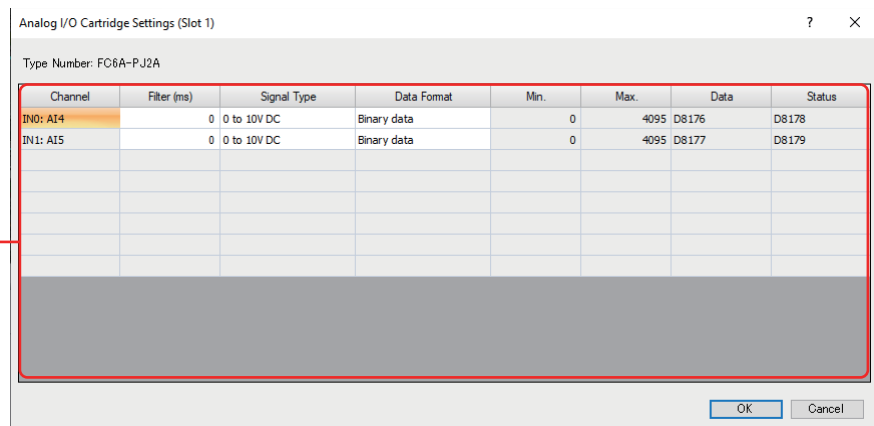

#### ■ Type Number

Displays the type number of the cartridge placed in the cartridge slot.

### ■ (Parameter Setting List)

**Channel:** Displays the analog inputs or analog outputs assignments. For details, refer to "4.1 I/O Assignments" on page 4-7.

**Filter (ms):** The analog input of the analog input cartridge is filtered to reach approximately 99% of the analog input at the specified time.

Specifies the filter value (0 to 50000) in 50 milliseconds increments. However, when the value is 0, the analog input is not filtered.



- Even when the analog input varies rapidly, the filtered analog value can be made to vary smoothly by setting the filter.
- Analog output cartridges cannot be filtered.

Example: 100ms is set.

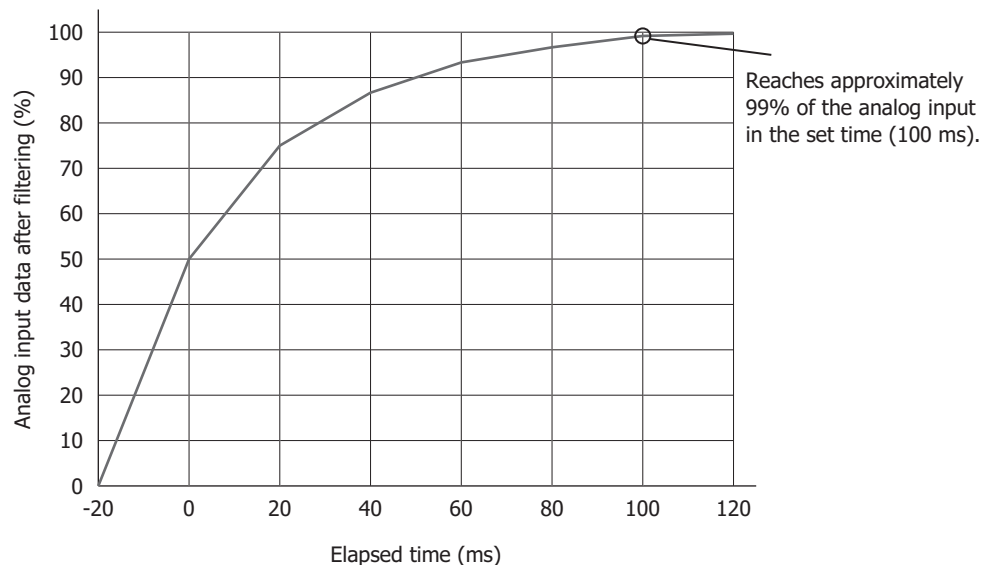

**Signal Type:** The signal type that can be set varies based on the analog I/O cartridge model.

FC6A-PJ2A: 0 to 10V DC, 0 to 20 mA DC, 4 to 20 mA DC

FC6A-PJ2CP: Type K, Type J, Type R, Type S, Type B, Type E, Type T, Type N, Type C, Pt100, Pt1000, Ni100, Ni1000

FC6A-PK2AV: 0 to 10V DC

FC6A-PK2AW: 4 to 20 mA DC

The performance and functionality of the analog I/O cartridge vary based on the version. For details about the version number, refer to Chapter 2 "Description Location of Version Number" on page 2-8.

**Data Format:** Select the data format that handles analog values from the following.

**Binary data:** Converts an analog value to a value in the range 0 to 4095.

**Optional range:** Converts the analog values to the set minimum and maximum value range. For details, refer to "Minimum, maximum values" on page 4-9.

**Celsius (°C), Fahrenheit (°F)\*1:** Linearly converts the input value of the temperature sensor selected in Signal Type. For detail, refer to "Minimum, maximum values" on page 4-9.

\*1 Analog input cartridge only

Minimum, maximum values : The minimum and maximum that can be set vary based on the item selected using **Data Format**.

Binary data The minimum value is 0 and the maximum value is 4095.

Optional range: -32768 to 32767

Celsius °C, Fahrenheit (°F)\*1: These vary based on the item selected for **Signal Type**. The minimum and maximum are as follows.

Signal Type	Celsius		Fahrenheit	
	Temperature (0.1°C)	Analog value	Temperature (0.1°F)	Analog value
Type K	-200.0 to 1,300.0	-2,000 to 13,000	-328.0 to 2,372.0	-3,280 to 23,720
Type J	-200.0 to 1,000.0	-2,000 to 10,000	-328.0 to 1,832.0	-3,280 to 18,320
Type R	0.0 to 1,760.0	0 to 17,600	32.0 to 3,200.0	320 to 32,000
Type S	0.0 to 1,760.0	0 to 17,600	32.0 to 3,200.0	320 to 32,000
Type B	0.0 to 1,820.0	0 to 18,200	32.0 to 3,308.0	320 to 33,080
Type E	-200.0 to 800.0	-2,000 to 8,000	-328.0 to 1,472.0	-3,280 to 14,720
Type T	-200.0 to 400.0	-2,000 to 4,000	-328.0 to 752.0	-3,280 to 7,520
Type N	-200.0 to 1,300.0	-2,000 to 13,000	-328.0 to 2,372.0	-3,280 to 23,720
Type C	0.0 to 2,315.0	0 to 23,150	32.0 to 4,199.0	320 to 41,990
Pt100	-200.0 to 850.0	-2,000 to 8,500	-328.0 to 1,562.0	-3,280 to 15,620
Pt1000	-200.0 to 600.0	-2,000 to 6,000	-328.0 to 1,112.0	-3,280 to 11,120
Ni100	-60.0 to 180.0	-600 to 1,800	-76.0 to 356.0	-760 to 3,560
Ni1000	-60.0 to 180.0	-600 to 1,800	-76.0 to 356.0	-760 to 3,560

Data : Displays the special data registers that store the analog value for the analog inputs or analog outputs of the analog I/O cartridge. The values of device addresses are updated with each scan.

D8176: Analog value of the analog I/O cartridge (Slot1) (AI4/AQ2)

D8177: Analog value of the analog I/O cartridge (Slot1) (AI5/AQ3)

D8186: Analog value of the analog I/O cartridge (Slot2) (AI6/AQ4)

D8187: Analog value of the analog I/O cartridge (Slot2) (AI7/AQ5)



- The values of special data registers for unused channels (analog output cartridges whose Signal Type is set to Unused or slots without analog I/O cartridges installed) are undefined.
- If the filter is enabled on an analog input, the filtered value is stored in the special data register.
- The values of special data registers to store analog values are updated regardless of whether the ladder program is stopped or running.

\*1 Analog input cartridge only

Status : Displays the special data registers that store the status of the analog inputs or analog outputs expanded using analog I/O cartridges.

D8178: Analog I/O cartridge status (Slot1) (AI4/AQ2)

D8179: Analog I/O cartridge status (Slot1) (AI5/AQ3)

D8188: Analog I/O cartridge status (Slot2) (AI6/AQ4)

D8189: Analog I/O cartridge status (Slot2) (AI7/AQ5)



The values of special data registers to store the status of the analog inputs or analog outputs are updated in the scan end processing.

#### Analog input

Status	Description			Analog value
0	Operating normally			Current analog value
1	Converting data (after the power is turned on and after the project is downloaded)			Undefined
2	Initializing			0
3, 4	Reserved			—
5	Wiring fault (out of maximum range)			
	Signal type	Voltage	0 to 10 V	V100 <sup>*1</sup> : 10.0 V or higher V201 <sup>*1</sup> or later: 10.2 V or higher
		Current	0 to 20 mA	V100 <sup>*1</sup> : 20.0 mA or higher V201 <sup>*1</sup> or later: 20.4 mA or higher
			4 to 20 mA	V100 <sup>*1</sup> : 20.0 mA or higher V201 <sup>*1</sup> or later: 20.32 mA or higher
		Thermocouple	Maximum value or higher	
Resistance thermometer	Maximum value or higher			
6	Wiring fault (out of minimum range, open current loop)			
	Signal type	Voltage	0 to 10 V	V100 <sup>*1</sup> : 0 V or lower V201 <sup>*1</sup> or later: -0.2 V or lower
		Current	0 to 20 mA	V100 <sup>*1</sup> : 0 mA or lower V201 <sup>*1</sup> or later: -0 mA or lower
			4 to 20 mA	V100 <sup>*1</sup> : 4.0 mA or lower V201 <sup>*1</sup> or later: 3.68 mA or lower
		Thermocouple	Minimum value or higher	
Resistance thermometer	Minimum value or higher			
7	Reserved (Analog I/O cartridge correction value error)			—
8	There is a difference in the configured content for the installed analog input cartridge and the Module Configuration Editor.			Undefined
9	The analog input cartridge has not been installed.			Undefined
10 to 65535	Reserved			—

\*1 Version Number of the analog input cartridge. The version number is printed on the side of the analog I/O cartridge. For details, refer to Chapter 2 "Description Location of Version Number" on page 2-8.



## Analog output

Status	Description	Analog value
0	Operating normally	Current analog value
1	Reserved	—
2	Initializing	0 V / 4 mA
3	Parameter setting error	Analog value immediately before the error occurred
4 to 7	Reserved	—
8	There is a difference in the configured content for the installed analog output cartridge and the Module Configuration Editor.	0 V / 4 mA
9	The analog output cartridge has not been installed.	—
10	The analog output cartridge has been installed, but Unused is selected as Signal Type.	0 V / 4 mA
11 to 65535	Reserved	—

# About the Warranty of the products

## 1 Warranty Period

The warranty period for IDEC products shall be three (3) year after purchase or delivery to the specified location. However, this shall not apply in cases where there is a different specification in the Catalogs or there is another agreement in place between you and IDEC.

## 2 Warranty scope

Should a failure occur in an IDEC product during the above warranty period for reasons attributable to IDEC, then IDEC shall replace or repair that product, free of charge, at the purchase location/delivery location of the product, or an IDEC service base. However, failures caused by the following reasons shall be deemed outside the scope of this warranty.

- i. The product was handled or used deviating from the conditions/environment listed in the Catalogs
  - ii. The failure was caused by reasons other than an IDEC product
  - iii. Modification or repair was performed by a party other than IDEC
  - iv. The failure was caused by a software program of a party other than IDEC
  - v. The product was used outside of its original purpose
  - vi. Replacement of maintenance parts, installation of accessories, or the like was not performed properly in accordance with the user's manual and Catalogs
  - vii. The failure could not have been predicted with the scientific and technical standards at the time when the product was shipped from IDEC
  - viii. The failure was due to other causes not attributable to IDEC (including cases of force majeure such as natural disasters and other disasters)
- \* Customers assume their own risk in programming products, Company will not be held liable for damages as a result of improper programming.

Furthermore, the warranty described here refers to a warranty on the IDEC product as a unit, and damages induced by the failure of an IDEC product are excluded from this warranty.

## 3 Service scope

The prices of IDEC products do not include the cost of services, such as dispatching technicians. Therefore, separate fees are required in the following cases.

- (1) Instructions for installation/adjustment and accompaniment at test operation (including creating application software and testing operation, etc.)
- (2) Maintenance inspections, adjustments, and repairs
- (3) Technical instructions and technical training
- (4) Product tests or inspections specified by you

# IDEC CORPORATION

**Head Office** 6-64, Nishi-Miyahara-2-Chome, Yodogawa-ku, Osaka 532-0004, Japan

 [www.idec.com](http://www.idec.com)

**USA** IDEC Corporation  
**EMEA** APEM SAS

**Singapore** IDEC Izumi Asia Pte. Ltd.  
**Thailand** IDEC Asia (Thailand) Co., Ltd.  
**India** IDEC Controls India Private Ltd.

**China** IDEC (Shanghai) Corporation  
IDEC Izumi (H.K.) Co., Ltd.  
**Taiwan** IDEC Taiwan Corporation

**Japan** IDEC Corporation

Specifications and other descriptions in this manual are subject to change without notice.  
Information in this manual is current as of July, 2024.

2023 IDEC Corporation, All Rights Reserved.

B-2339(2)

