

INSTRUCTION SHEET



FT1A Series

Confirm that the delivered product is what you have ordered. Read this instruction sheet to make sure of correct operation. Make sure that the instruction sheet is kept by the end user. This manual is the instruction sheet of the SmartAXIS Series FT1A Touch. Unless otherwise specified, SmartAXIS refers to the SmartAXIS Series FT1A Touch.

Touch	The generic term for the SmartAXIS FT1A-*12RA-*, FT1A-*14KA-* and FT1A-*14SA-*
-------	--

Safety Precautions

- Be certain to read this manual carefully before performing installation, wiring, or maintenance work, or operating the Touch.
- This product has been manufactured with careful regard to quality. However, if you intend to use this product in applications where failure of this equipment may result in damage to property or injury, ensure that it used in conjunction with appropriate fail-safe backup equipment.
- In this manual, safety precautions are categorized in order of importance to Warning and Caution:

**WARNING**

Warning notices are used to emphasize that improper operation may cause severe personal injury or death.

**CAUTION**

Caution notices are used where inattention might cause personal injury or damage to equipment.

**WARNING**

- The Touch is not intended to be used for applications which require high reliability and safety, such as medical equipment, nuclear equipment, railways, aircraft, and vehicles. The Touch cannot be used for these applications.
- For other applications which require high reliability in function and precision, provide a failsafe design and redundant design for the entire system including the Touch.
- Emergency and interlocking circuits must be configured outside of the Touch.
- If relays in the Touch output circuits should fail, outputs may remain at on or off state. For output signals which may cause serious accidents, configure monitor circuits outside the Touch.
- The Touch self-diagnostic function may detect internal circuit or program errors, stop programs, and turn outputs off. Configure circuits so that the system containing the Touch are not jeopardized when outputs turn off.
- Emergency and interlocking circuits must be configured outside of the Touch. Do not use the Touch's internal touch switches for an emergency circuit. If the Touch failed, the external equipment connected to the Touch will no longer be protected and serious injury to operators and equipment damage may be caused.
- Turn off the power to the Touch before installation, removal, wiring, maintenance, and inspection of the Touch. Failure to turn power off may cause electrical shock or fire hazard.
- Special expertise is required to install, wire, configure, and operate the Touch. People without such expertise must not use the Touch.
- The Touch uses an LCD (liquid crystal display) as a display device. The liquid inside the LCD is harmful to the skin. If the LCD is broken and the liquid attaches to your skin or clothes, wash the liquid off using soap, and consult a doctor immediately.
- <Hazardous locations warnings>  
The following equipment is suitable for use in Class I, Division 2, Groups A, B, C and D hazardous locations, or non hazardous locations only.  
FT1A-M12RA type (version V121), FT1A-C12RA type (version V121, V200), FT1A-M/C14KA/SA (version V110 or later) [TC: T4A]  
The following equipment is suitable for use in Class I, Division 2, Groups C and D hazardous locations, or non hazardous locations only.  
FT1A-M12RA type (version V200 or later), FT1A-C12RA type (version V300 or later) [TC: T4A] [TC: Temperature code]

- This equipment is an open-type device meant to be installed in an enclosure suitable for the environment that is only accessible with the use of a tool or key.
- Warning - Explosion Hazard - Do not disconnect equipment while the circuit is live or unless the area is known to be free of ignitable concentrations.
- Avertissement: Risque d'explosion. Ne pas débrancher tant que le circuit est sous tension, à moins qu'il ne s'agisse d'un emplacement non dangereux.

**CAUTION**

- Prevent the Touch from falling while moving or transporting, otherwise damage or malfunction of the Touch will result.
- Use the product within the environmental limits given in the catalog and manual. Use of the product in high-temperature or high-humidity environments, or in locations where it is exposed to condensation, corrosive gas or large shock loads can create the risk of electrocution and fire.
- The Touch is designed for use in pollution degree 2. Use the Touch in environments of pollution degree 2. (based on the IEC60664-1 rating)
- Install the Touch according to the instructions in the User's Manual. Improper installation will result in falling, failure, electrical shock, fire hazard, or malfunction of the Touch.
- Prevent metal fragments or wire chips from dropping inside the Touch housing. Ingress of such fragments and chips may cause fire hazard, damage, and malfunction.
- Use a power supply of the rated value. Using a wrong power supply may cause fire hazard.
- The Touch uses "PS2 of EN61131" as DC power supply. (based on the IEC/EN61131 rating)
- Use wire of a proper size to meet the voltage and current requirements.
- When exporting the Touch to Europe, use an EN60127 (IEC60127) approved fuse on the power line outside the Touch.
- When exporting the Touch to Europe, use an EU-approved circuit protector.
- Make sure of safety before starting and stopping the Touch. Incorrect operation of the Touch may cause mechanical damage or accidents.
- Use the Touch in a local area network if you download, upload or monitor the project data via the Ethernet port.
- The touch panel of the Touch is made of glass, and will break if exposed to excessive shock. Take due care when handling it.
- When more than one button is pressed at the same time, due to the detection characteristics of an analog type touch panel, only the gravity center of the pressed area is sensed and the unit assumes that only one button is pressed. Thus, when more than one button is pressed simultaneously, the resulting operation is not guaranteed.
- The screen becomes blank when the backlight is burnt out; however, the touch panel remains enabled. Incorrect touch panel operation will occur when operating the touch panel when the backlight appears to be turned off but is actually burnt out. Note that this erroneous operation may result in damage.
- Do not push hard or scratch the touch panel and protection sheet with a hard object such as a tool, because they are damaged easily.
- At temperatures over the rated operating temperature, the clock accuracy is affected. Adjust the clock before use.

- For applications which require clock accuracy, adjust the clock periodically.
- Do not install the Touch in areas subjected to strong ultraviolet rays, since ultraviolet rays may impair the quality of the LCD.
- Do not attempt to disassemble, repair or modify the Touch. This can create the risk of fire or electrocution.
- When disposing of the Touch, do so as an industrial waste.
- Do not switch off the power or pull out the USB Flash Drive while it is being accessed, as this may result in destruction of the stored data. If the data on the USB Flash Drive is corrupted, format the USB Flash Drive.
- Handling of Batteries and Devices with Built-in Batteries in EU Member States  
Note) The right symbol mark is for EU countries only and is according to the directive 2006/66/EC Article 20 information for end-users and Annex II.  
This symbol mark means that batteries and accumulators, at their end-of life, should be disposed of separately from your household waste.  
If a chemical symbol is printed beneath the symbol shown above, this chemical symbol means that the battery or accumulator contains a heavy metal at a certain concentration. This will be indicated as follows :  
Hg : mercury (0.0005%), Cd : cadmium (0.002%), Pd : lead (0.004%)  
In the European Union there are separate collection systems for used batteries and accumulators. Please dispose of batteries and accumulators correctly in accordance with each country or local regulation.



- Regarding the Marine Standard Approved  
This product (FT1A-\*14KA/SA and FT1A-\*12RA (FT1A Version V120 or later)) complies with the following Marine Standard.  
- ABS (American Bureau of Shipping), DNV GL (DNV GL AS), LR (Lloyd's Register of Shipping), NK (Nippon Kaiji Kyokai) (Regarding the usable area, environment, please contact us.)  
- When using this product as the Marine Standard Approved Products, attach a ferrite core (ZCAT3035-1330 manufactured by TDK Corporation) to the power cables (2 turns), the cable for each communication port (2 turns). And attach a ferrite core (ZCAT3035-1330 manufactured by TDK Corporation) to the cable for communication cartridge (2turns).
- Recommended continuous turn on time is 15 hours when first use or did not turn on for a long time. When battery charging and discharging is repeated without that, battery life becomes shorter than the specification value.

1 Packing

Before installing the Touch, make sure that the specifications of the product conform to your requirements, and that no parts are missing or damaged due to accidents during transportation.

- Touch Unit 1
- Power plug (Attached to the Touch) 1
- Communication I/F plug (Attached to the Touch) 1
- Mounting clips 2
- USB Cable Lock Pin 2
- USB Clamp Band 2

2 Part Names

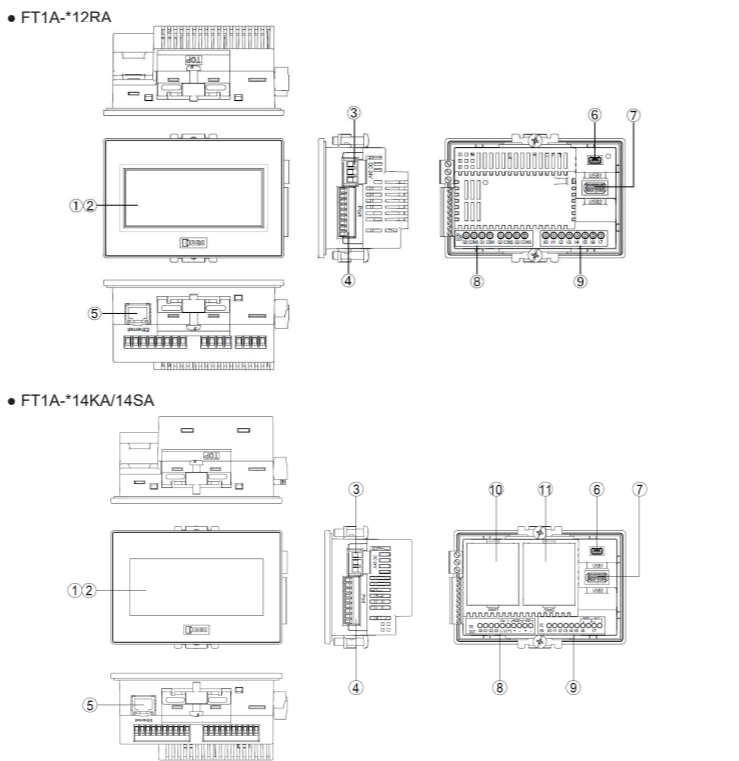

No.	Name	Description	
		FT1A-*12RA	FT1A-*14RA/14SA
(1)	Display		
(2)	Touch Panel		
(3)	Power Supply Terminal		
(4)	Serial Interface (Port)	RS232C, RS422/485	Connector: Terminal Block 9 pin
(5)	Ethernet Interface (Ethernet)	IEEE802.3u 10BASE-T/100BASE-TX	Connector: RJ-45
(6)	USB Interface (USB1)	USB2.0 (Device)	Connector: Mini-B
(7)	USB Interface (USB12)	USB1.1 (External device)	Connector: TypeA
(8)	Output Terminal (Q0 to Q3)	Relay output (10A)	
	Terminal (Q0 to Q3, AQ0 to AQ1)		Transistor output, Analog output
(9)	Input Terminal (I0 to I7)	Digital input, Analog input	
(10)	Slot 1		Optional device (Sold separately)
(11)	Slot 2		Digital, Analog I/O cartridge

3 External Interfaces

**CAUTION**

Make sure to turn off the power to the Touch before wiring each interface. Always use ferrules when wiring stranded wire and multiple wires to the terminal block. Otherwise there is a risk of wires becoming disconnected.

- Serial Interface (Port)

Interface Specification	RS232C, RS422/485
Connector	Detachable Terminal Block 9pin
Applicable cable	RS232C: AWG16 to AWG28 RS422/485: AWG16 to AWG28 Shielded twisted-pair Stripped wire length 7mm (Solid wire)
Recommended ferrule	H0,34/12 TK (For AWG22), H0,5/14D W, H0,5/14 OR (For AWG20) H0,5/14D ZH W, H0,5/14 ZH OR (For AWG20, For 2 wires) (Weidmüller) AI 0,34-8 TQ (For AWG22), AI 0,5-8 WH (For AWG20) AI-TWIN2x0,5-8WH (For AWG20, For 2 wires) (Phoenix Contact)
Tightening Torque	0.25N-m

No.	Name	I/O	Function	Communication type
1	SD	OUT	Send Data	RS232C
2	RD	IN	Receive Data	
3	RS	OUT	Request to Send	
4	CS	IN	Clear to Send	RS485/422
5	SG	-	Signal Ground	
6	SDA	OUT	Send Data (+)	
7	SDB	OUT	Send Data (-)	
8	RDA	IN	Receive Data (+)	
9	RDB	IN	Receive Data (-)	

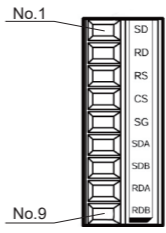

Note:  
The Touch is not equipped with terminating resistance. When using the RS422/485 interface, insert terminating resistance with the appropriate value (around 100 to 120 Ω) between terminal No. 8 (RDA) and terminal No. 9 (RDB) as required.

- I/O Terminals

Type	FT1A-*12RA	FT1A-*14KA/14SA
Applicable cable	AWG16 to AWG22 Stripped wire length 6.5 mm, coating diameter ø3.4 mm or lower (Solid wire)	AWG20 to AWG22 Stripped wire length 5 mm, coating diameter ø2.6 mm or lower (Solid wire)
Recommended ferrule	H0,34/12 TK (For AWG22, For 1 wire) H0,5/14D W, H0,5/14 OR (For AWG20, For 1 wire) H0,75/14D GR, H0,75/14W, H1,0/16D R, H1,0/16GE (For AWG18, For 1 wire) H0,75/16D ZH GR, H0,75/16 ZH W (For AWG18, For 2 wire) H1,5/16D SW, H1,5/16R (For AWG16, For 1 wire) (Weidmüller) AI 0,34-8 TQ (For AWG22, For 1 wire) AI 0,5-8 WH (For AWG20, For 1 wire) AI 0,75-8 GY, AI 1-10 RD (For AWG18, For 1 wire) AI-TWIN 2x0,75-10 GY (For AWG18, For 2 wire) AI 1,5-10 BK (For AWG16, For 1 wire) (Phoenix Contact)	H0,34/12 TK (For AWG22, For 1 wire) H0,5/14D W, H0,5/14 OR (For AWG20, For 1 wire) H0,5/14D ZH W, H0,5/14 ZH OR (For AWG20, For 2 wire) (Weidmüller) AI 0,34-8 TQ (For AWG22, For 1 wire) AI 0,5-8 WH (For AWG20, For 1 wire) AI-TWIN2x0,5-8WH (For AWG20, For 2 wire) (Phoenix Contact)
Tightening Torque	0.5 to 0.6N-m	0.2N-m
Screwdrive	SZS 0.6x3.5 (Phoenix Contact)	SZS 0.4x2.5 (Phoenix Contact)

Terminal Arrangement (Terminal Arrangement and I/O Wiring Diagrams)

- FT1A-\*12RA

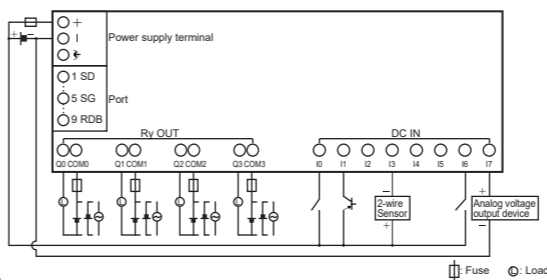

- FT1A-\*14KA

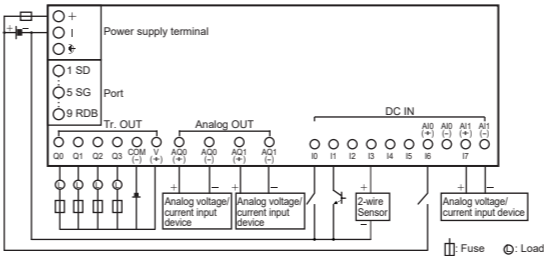

- FT1A-\*14SA

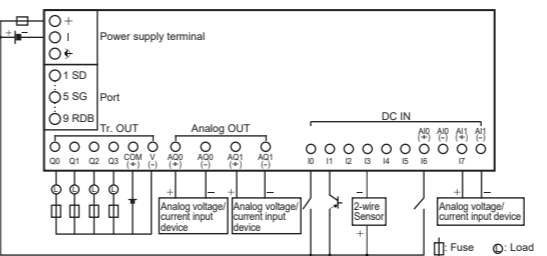

4 Specifications

- Applicable Standards

Safety Standard	UL508, CSA C22.2 No.142 (c-UL)
EMC Standard*1	IEC/EN 61131-2:2007

\*1: When using the Touch as the EMC Standard Approved Products, attach a ferrite core (ZCAT3035-1330 manufactured by TDK Corporation) to the power cables and the communication cables. If there a risk of an error occurring due to noise, install the product separated from sources of noise such as power lines, high voltage lines, and load lines. Also attach a ferrite core to the I/O cable (ZCAT3035-1330 manufactured by TDK Corporation).

- Environmental Specifications

Operating Temperature	0 to 55°C: FT1A-M (Monochrome LCD models) -20 to 55°C: FT1A-C (Color LCD models) (No freezing)
Relative	10 to 95% RH (No condensation)
Storage Temperature	-20 to +60°C (No freezing)
Storage Humidity	10 to 95% RH (No condensation)
Altitude	Operation: 0 to 2,000m Transport: 0 to 3,000m
Pollution Degree	2
Corrosion Immunity	Free from corrosive gases

- Electrical Specifications

Type	FT1A-*12RA	FT1A-*14KA/14SA
Rated Voltage	24V DC	
Power Consumption	9.2W max. When USB2 is unused: 5.8W max.	11.0W max. When USB2 is unused: 8.1W max.
Power Voltage Range	20.4 to 28.8V DC	
Allowable Momentary Power	10 msec max.	
Interruption	50A max.	

5 Dimensions

- FT1A-\*12RA

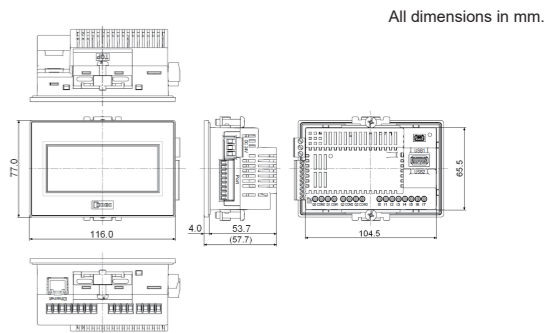

<Cable Attached Dimensions>

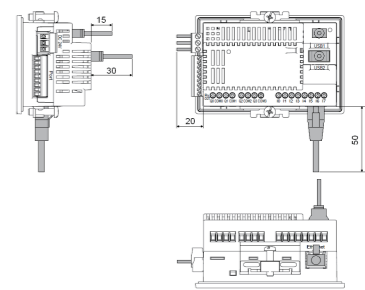

- FT1A-\*14KA/14SA

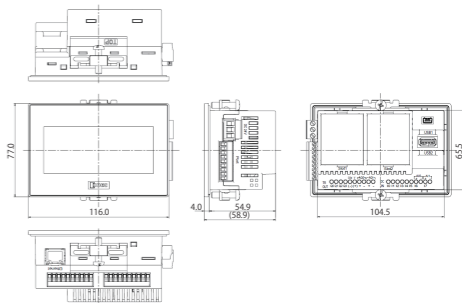

<Cable Attached Dimensions>

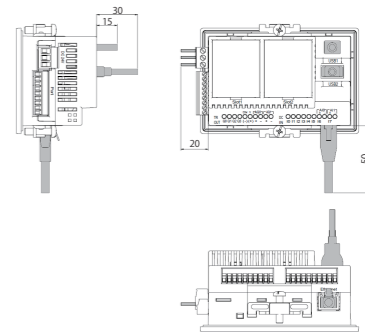

Depending on the type of connection cable used the dimensions shown above will change. The dimensions given here are intended for reference only.

## 6 Installation

- **Operating Environment**  
For designed performance and safety of the Touch, do not install the Touch in the following environments:
  - Where dust, briny air, or iron particles exist.
  - Where oil or chemical splashes for a long time.
  - Where oil mist is filled.
  - In direct sunlight.
  - Where strong ultraviolet rays exist.
  - Where corrosive or combustible gasses exist.
  - Where the Touch is subjected to shocks or vibrations.
  - Where condensation occurs due to rapid temperature change.
  - Where high-voltage or arc-generating equipment (electromagnetic contactors or circuit protectors) exists in the vicinity.

- **Ambient Temperature**
  - Allow sufficient space for ventilation, and install the equipment away from heat sources.
  - Allow at least 100mm between the Touch and walls or other equipment.
  - Do not install the Touch where the ambient temperature exceeds the rated operating ambient temperature range. When mounting the Touch in such locations, provide a forced air-cooling fan or air-conditioner to keep the ambient temperature within the rated temperature range.
  - The Touch is designed to install on a vertical plane so that natural air-cooling is provided. If you install it using any other orientation, use forced-air cooling, or lower the ambient operating temperature.

- **Derating**
  - FT1A-\*12RA  
When using the Touch at an ambient temperature of 45°C or higher, reduce the output current of each output terminal as shown in the figure below.  
[Installed upright in landscape orientation]

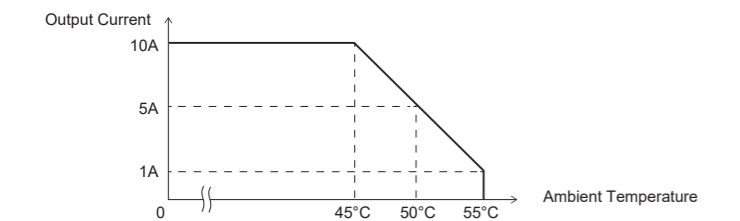

Note:  
If operating the Touch in a high-temperature environment, reducing the brightness of the backlight can help to limit the temperature rise of internal components.  
The relationship between ambient temperature, the output current of each output terminal, and brightness is approximately as shown in the figure below.

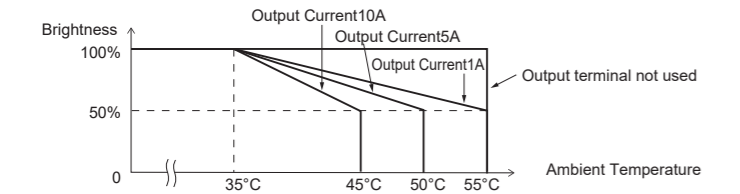

The values shown above may vary with individual products. Please use this information as a reference at the time of design.

- FT1A-\*14KA/14SA  
When used at ambient temperatures of 40°C or higher, limit the usage of analog current output and the analog cartridge as shown in the figure below.

Power Voltage Range	Touch Analog Output	Cartridge	Operating Temperature
20.4 to 24V DC	Voltage/current output cannot be used	Voltage output (FC6A-PK2AV)/current output (FC6A-PK2AW) cannot be used	55°C
20.4 to 28.8V DC	Current output cannot be used	Voltage output (FC6A-PK2AV)/current output (FC6A-PK2AW) cannot be used	50°C
20.4 to 28.8V DC	No restrictions	Voltage output (FC6A-PK2AV)/current output (FC6A-PK2AW) cannot be used	45°C
20.4 to 28.8V DC	Current output cannot be used	Current output (FC6A-PK2AW) cannot be used	45°C
20.4 to 28.8V DC	No restrictions	No restrictions	40°C

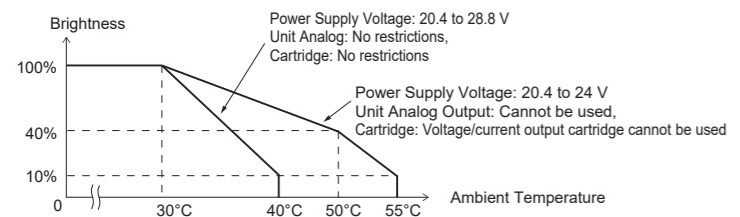

Note:  
If operating the FT1A-\*14KA/14SA in a high-temperature environment, reducing the brightness of the backlight can help to limit the temperature rise of internal components.  
The relationship between ambient temperature and brightness is approximately as shown in the figure below.

The values shown above may vary with individual products. Please use this information as a reference at the time of design.

- **Installation**
  - Make a panel cut-out on the panel with the dimensions shown below.

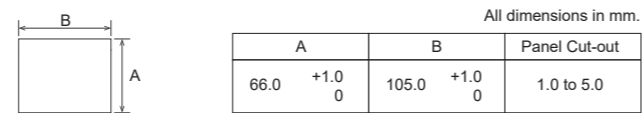

- The Touch has the mounting clip positions not only on the top and bottom side (0.3 to 0.35 N-m).

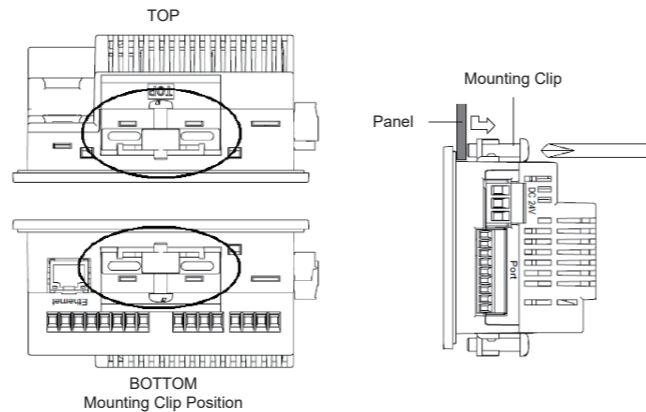

### CAUTION

- Do not tighten excessively, otherwise the Touch may warp and cause wrinkle on the display, or impair the waterproof characteristics.
- If the mounting clips are tightened obliquely to the panel, the Touch may fall off the panel.
- When installing the Touch into a panel cut-out, make sure that the gasket is not twisted. Especially when re-installing, take special care because any twists in the gasket will impair the waterproof characteristics.
- Even in the panel thickness range, there is a risk that the waterproof characteristics cannot be maintained due to the panel materials and size.

- **Orientation**  
The Touch is designed to install on a vertical landscape. If you install it with any other orientation, confirm the limitations about operating temperature.

Operating Temperature	FT1A-M Monochrome LCD models		FT1A-C Color LCD models		FT1A-C Color LCD models	
	0 to 55°C	0 to 50°C	0 to 55°C	0 to 55°C	0 to 55°C	0 to 50°C
Orientation	Landscape	Portrait (Clockwise)	Portrait (Counter Clockwise)	Landscape (Rotated 180°)	Horizontal	

### CAUTION

When installing the Touch in a diagonal, the limitations are same as a horizontal. Confirm the visibility of the display in a final installation.

## 7 Power Supply Wiring

### CAUTION

- Turn off the power supply before wiring.
- Make the wiring as short as possible and run all wires as far away as possible from high-voltage and large-current cables. Follow all the procedures and precautions when wiring the Touch.
- Separate the Touch power supply wiring from the power lines of I/O devices and motor equipment.
- Ground the functional earth terminal to make sure of correct operation.
- Always use ferrules when wiring stranded wire and multiple wires to the terminal block. Otherwise there is a risk of wires becoming disconnected.

- **Power Supply Terminal**  
• Pin assignment is shown in the following table.

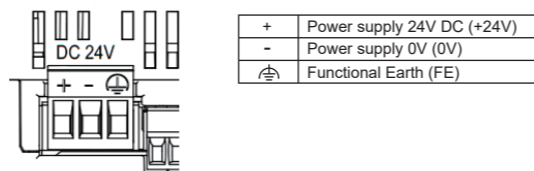

- Use applicable cables for wiring and recommended ferrules (made by Weidmüller or Phoenix Contact) as follows.

Applicable cable	AWG16 to AWG22, Stripped wire length 7 mm (Solid wire)
	H0,34/12 TK (For AWG22), H0,5/14D W, H0,5/14 OR (For AWG20) H0,75/14D GR, H0,75/14 W, H1,0/14D R, H1,0/14 GE (For AWG18) H1,5/14D SW, H1,5/14 R (For AWG16) H0,5/14D ZH W, H0,5/14 ZH OR (For AWG20, TWIN Pressure Terminal) H0,75/14D ZH GR, H0,75/14 ZH W (For AWG18, TWIN Pressure Terminal) (Weidmüller)
	AI 0,34-8 TQ (For AWG22), AI 0,5-8 WH (For AWG20) AI 0,75-8 GY (For AWG18), AI 1-8 RD (For AWG18), AI 1,5-8 BK (For AWG16) AI-TWIN 2×0,5-8 WH (For AWG20, TWIN Pressure Terminal) AI-TWIN 2×0,75-8 GY (For AWG18, TWIN Pressure Terminal) (Phoenix Contact)
Tightening Torque	0.5 to 0.6N-m

- **Cautions when connecting external devices**  
The Touch power supply is non-isolating. Interference or external noise from external devices due to wiring may cause adverse effects on the internal circuits of the Touch or external devices. To prevent such damage, choose a proper solution depending on your system setup.
  - Use a separate earth ground from the external noise source device.
  - The wire for grounding should be thick and short in order to direct the noise from the noise source device to the earth ground.
  - Use a separate power supply from the external noise source device.
  - Insert an isolator on the communication line of the Touch and the non-isolated communication device (i.e. PLC) to prevent damage.

- **Cautions for using the Touch connected to a personal computer**  
When connecting the Touch to a computer via the Serial Interface (Port) or USB Interface, the Touch or the computer may break down depending on the conditions of the computer. Make sure of the following cautions, in order to prevent an accident.
  - If the computer has a 3-pin power plug or power plug with a ground lead type.  
Make sure to use a plug socket including a ground input electrode or ground the earth lead, respectively.
  - If the computer has a 2-pin power plug without ground lead, follow the procedure below when connect the Touch to the computer.
    - (1) Pull out the power plug of the computer from the AC outlet.
    - (2) Connect the Touch to the computer.
    - (3) Insert the power plug of the computer into the AC outlet.

## 8 USB Cable Lock Pin Attachment

When using the USB interface (USB1, USB2), attach the USB cable lock pin to prevent disconnecting the USB cable from the Touch.

- (1) Insert the USB cable into the USB port.
- (2) Strain the "Edge part" of the USB cable lock pin, and insert the "Edge part" to the 2 holes upper the USB port.
- (3) Fasten the USB clamp band around the USB cable and the clamp part, secure them tightly.

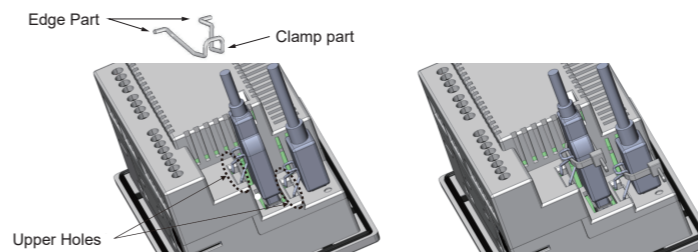

Note:  
Fasten the USB clamp band without the space between the clamp part and it, and the inclination.

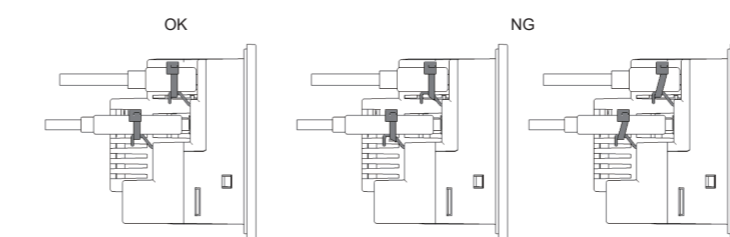

## 9 Maintenance and Inspection

Maintain and inspect the Touch periodically to ensure the best performance. Do not disassemble, repair, or modify the Touch during inspection.

Display	Wipe any stain of the display using a soft cloth slightly dampened with neutral detergent or alcoholic solvent. Do not use solvents such as thinner, ammonia, strong acid, and strong alkaline.
Terminals, Connectors	Check the terminals and connectors to make sure of no loose screws, incomplete insertion, or disconnected lines.
Mounting Clips	Make sure that all mounting clips and screws are tightened sufficiently. If the mounting clips are loose, tighten the screw to the recommended tightening torque.
Backlight	The Touch backlight cannot be replaced by the customer. When the backlight needs to be replaced, contact IDEC.
Touch Panel	A gap may be caused in the operation accuracy of the touch panel by the secular distortion, etc. Adjust the touch panel according to the following procedure when there is a gap in the operation of the touch panel.

- **Maintenance Screen**  
Turn on the power to the Touch, then press and hold the upper-left corner of the screen for three seconds or longer. The Maintenance Screen appears on the screen.

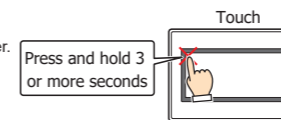

Maintenance Screen (Color LCD models)

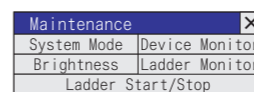

Maintenance Screen (Monochrome LCD models)

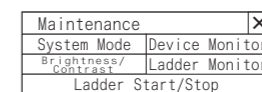

- Permission to show the Maintenance Screen can be set using the configuration software. Refer to the User's Manual for details.
- The Maintenance Screen is not displayed in the System Mode.

- **System Mode**  
Press the System Mode at the top of the Maintenance Screen. The Top page Screen appears.

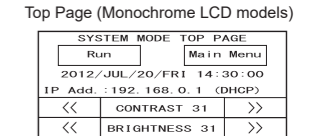
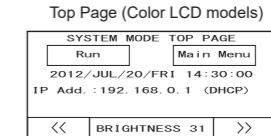

Initial Setting, Self Diagnosis and Initialization of the data, etc can be executed in the System mode.

- **Adjusting the Brightness and Contrast**  
The brightness and contrast of the Touch display can be adjusted on the Adjust Brightness/Contrast Screen. Adjust the brightness and contrast to the best condition as required.

- (1) Press the Brightness (color LCD models) or Brightness/Contrast (monochrome LCD models) on the Maintenance Screen. The Adjust Brightness/Contrast Screen appears.

Color LCD models

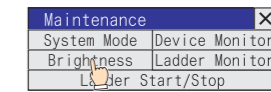

Monochrome LCD models

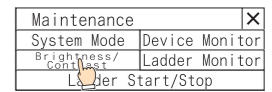

- (2) Press << and >> at the bottom the Adjust Brightness/Contrast Screen to adjust the contrast to the optimal setting.

Color LCD models



Monochrome LCD models



- (3) Press × to close the Adjust Brightness/Contrast Screen. To adjust the brightness and Contrast in the System Mode, use << and >> located at the bottom of the Top Page.

Top Page (Color LCD models)

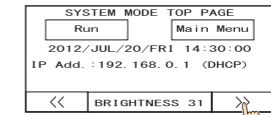

Top Page (Monochrome LCD models)

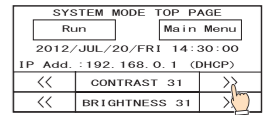

Note:  
Since contrast adjustment is not possible on color LCD models, the contrast adjust function is not displayed.

- **Adjusting the Touch Panel**  
(1) A gap may be caused in the operation accuracy of the touch panel by the secular distortion, etc. Adjust the touch panel according to the following procedure when there is a gap in the operation of the touch panel.  
Press Main Menu on Top Page in System Mode. The Main Menu appears.

Top Page (Color LCD models)

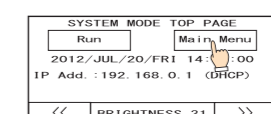

Top Page (Monochrome LCD models)

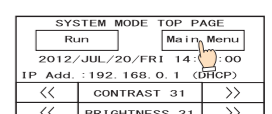

- (2) Press Init Set, Initialize, and then Touch PnlAdj. The confirmation screen appears and asks "Touch Panel setting?" is displayed. Press Yes. The Touch Panel Adjust Screen is displayed.

- (3) Press the center of the ×, then the position of the symbol changes one after another. Press five symbols sequentially.

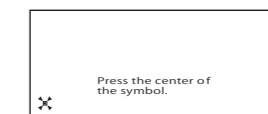

Note:  
When pressing the ×, make sure to press the center of the symbol. This will ensure the accuracy of the touch panel operation.

- (4) When normally recognized, the confirmation screen of (2) is restored. At step (3), when pressing a point away from the center of the ×, a recognition error will result. Then the × returns to the initial position, then repeat the step of (3) again.

SmartAXIS User's manual can be downloaded from [https://us.idec.com/c/SmartAXIS\\_FT1A](https://us.idec.com/c/SmartAXIS_FT1A)

## IDEC CORPORATION <http://www.idec.com>

Manufacturer: IDEC CORPORATION, 2-6-64 Nishimiyahara, Yodogawa-Ku, Osaka 532-0004, Japan  
EU Authorized Representative: APEM SAS  
55, Avenue Edouard Herriot BP1, 82303 Caussade Cedex, France  
UK Authorized Representative: APEM COMPONENTS LIMITED  
Drakes Drive, Long Crendon, Buckinghamshire, HP18 9BA, UK