

EB3C Relay Barriers

EB3L Lamp Barriers

EB3N Safety Relay Barriers



In order to establish an intrinsically safe explosion-proof system, a barrier must be selected depending on the type of device (such as) pushbutton, pilot light, and proximity switch that are installed in the hazardous area. See the selection chart below.

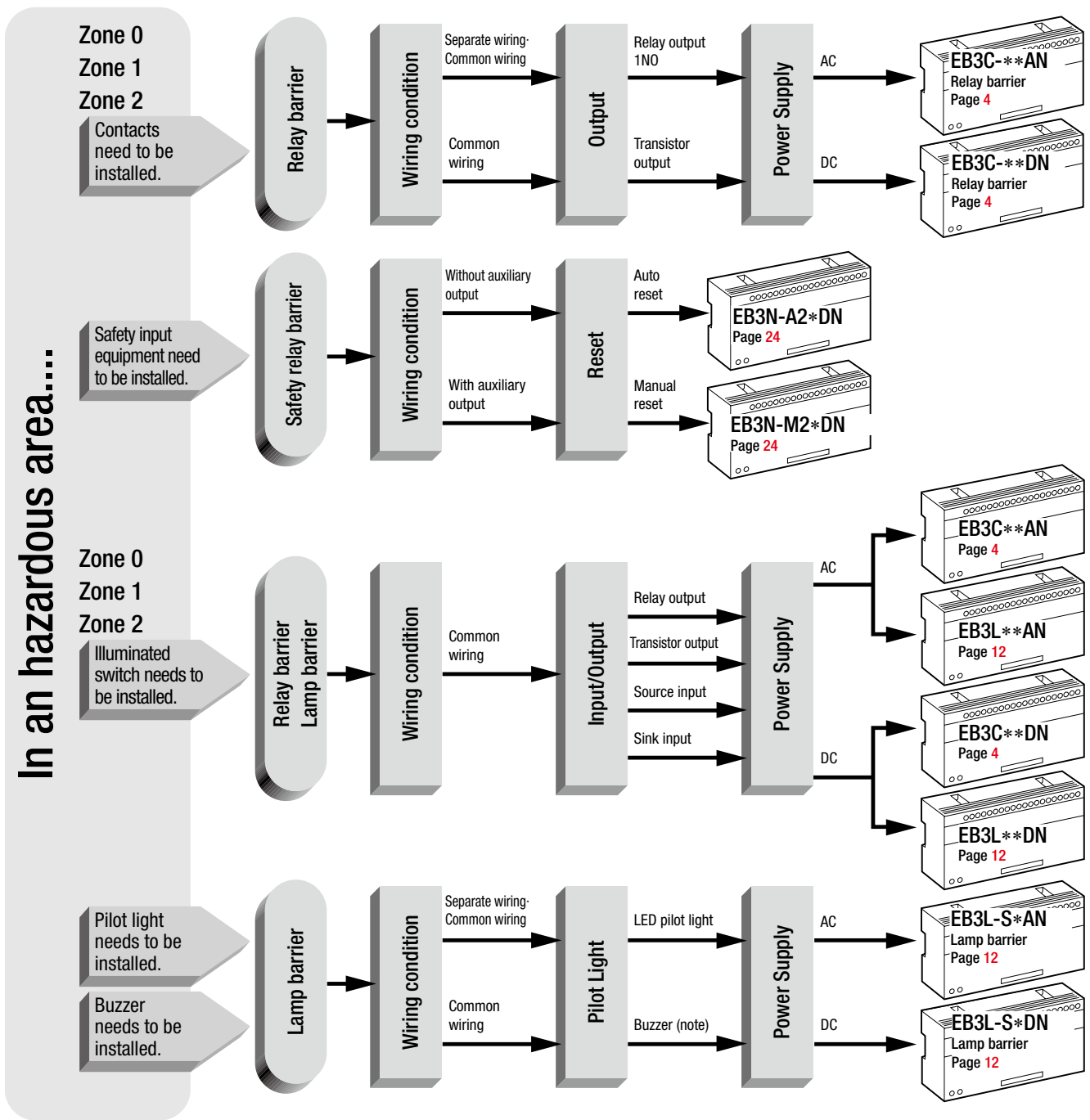

Relay Barrier

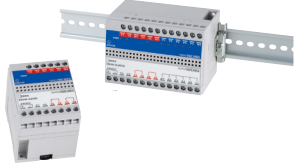
Model	EB3C-**-AN	EB3C-**-DN	EB3N-**-D
Shape			
Explosion Protection	FM: Class I, II, III Div1 / Group A, B, C, D, E, F, G Class I, Zone 0 / AEx [ia] II C UL: Class I, II, III Div1 / Group A, B, C, D, E, F, G Class I, Zone 0 / AEx [ia] II C PTB (ATEX, IECEx): [Exia] II C, Exia] III C CQST: [Exia Ga] II C TIIS: [Exia] II C KCS: [Exia] II C NK: [Exia] II C KR: [Exia] II C		Relay Barrier: [Exia] II C
Degree of Protection	IP20	IP20	IP20
No. of Channels	1, 2, 3, 5, 6, 8, 10, 16	1, 2, 3, 5, 6, 8, 10, 16	EB3N-□2ND: 2 safety circuits EB3N-□2R5D: 2 safety circuits, 5 auxiliary circuits
Power Voltage	100 to 240V AC	24V DC	24V DC
Output	Relay Transistor (Sink/Source)	Relay Transistor (Sink/Source)	Relay
Connection	Screw Terminal	Screw Terminal, Connector	Screw Terminal
Mounting	35-mm-wide DIN rail Panel mounting	35-mm-wide DIN rail Panel mounting	35-mm-wide DIN rail / Panel mounting
Size (excluding projections)	42W×75H×77.5D (1 channel) 65W×75H×77.5D (2, 3 channels) 110.5W×75H×77.5D (5, 6, 8 channels (common)) 171.5W×75H×77.5D (8, 10, 16 channels (common))	42W×75H×77.5D (1 channel) 65W×75H×77.5D (2, 3 channels) 110.5W×75H×77.5D (5, 6, 8 channels (common)) 171.5W×75H×77.5D (8, 10, 16 channels (common))	65.0W×75.0H×77.5D (EB3N-□2ND) 110.5W×75.0H×77.5D (EB3N-□2R5D)
Weight (approx.)	0.38kg (EB3C-R10AN)	0.39kg (EB3C-R16CDN)	220g (EB3N-□2ND) 300g (EB3N-□2R5D)
Page	4		24

Lamp Barrier

Model	EB3L-**-AN	EB3L-**-DN
Shape		
Explosion Protection	FM: Class I, II, III Div1 / Group A, B, C, D, E, F, G Class I, Zone 0 / AEx [ia] II C UL: Class I, II, III Div1 / Group A, B, C, D, E, F, G Class I, Zone 0 / [AEx ia] II C PTB (ATEX, IECEx): [Exia] II C, Exia] III C CQST: [Exia Ga] II C TIIS: [Exia] II C KCS: [Exia] II C NK: [Exia] II C KR: [Exia] II C	
Degree of Protection	IP20	IP20
No. of Channels	1, 2, 3, 5, 6, 8, 10	1, 2, 3, 5, 6, 8, 10, 16
Power Voltage	100 to 240V AC	24V DC
Input/Output	Transistor input (sink) Transistor input (source)	Transistor input (sink) Transistor input (source)
Connection	Screw Terminal	Screw Terminal, Connector
Mounting	35-mm-wide DIN rail Panel mounting	35-mm-wide DIN rail Panel mounting
Size (excluding projections)	42W×75H×77.5D (1 channel) 65W×75H×77.5D (2, 3 channels) 110.5W×75H×77.5D (5, 6, 8 channels (common)) 171.5W×75H×77.5D (8, 10 channels)	42W×75H×77.5D (1 channel) 65W×75H×77.5D (1 channel) 110.5W×75H×77.5D (5, 6, 8 channels (common)) 171.5W×75H×77.5D (8, 10, 16 channels (common))
Weight (approx.)	0.36kg (EB3L-S10SAN)	0.36kg (EB3L-S16CSDN)
Page	12	

EB3C Relay Barriers

Input contacts can be used in any explosive gas and Zone 0/Class I Div. 1 areas.

Explosion protection	Relay Barrier:	[Exia] II C
	Switch (EB9Z-A):	Exia II CT6
	Switch (EB9Z-A1):	Exia II BT6

- IEC60079 compliant.
- Wide variety of models ranging from 1-circuit to 16 circuit models.
- 8- and 16-channel are available in common wiring, ideal for connection to PLCs. 16-circuit also available with a connector.
- No grounding required.
- IDEC's original spring-up terminal minimizes wiring time.
- 35-mm-wide DIN rail mounting or direct screw mounting.
- Global usage
 - IECEX
 - USA: FM, UL
 - China: CQST
 - Taiwan: TS
 - Japan: TIIS
- Ship class: NK (Japan), KR (Korea)

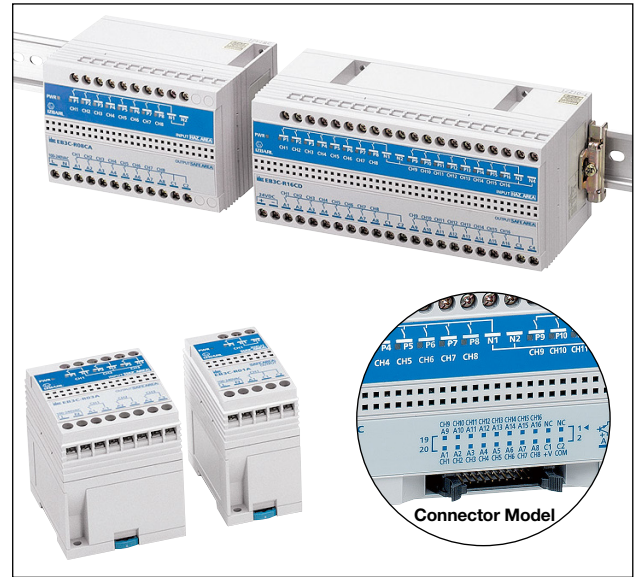

Relay Barriers

Power Voltage	Connection to Non-intrinsically Safe Circuit	Input Wiring Method	Output	Number of Channels	Part No.	Weight (g)
100 to 240V AC	Screw Terminal	Separate/Common Wiring Compatible	Relay	1	EB3C-R01AN	150
				2	EB3C-R02AN	180
				3	EB3C-R03AN	190
				5	EB3C-R05AN	260
				6	EB3C-R06AN	270
				8	EB3C-R08AN	300
				10	EB3C-R10AN	380
				8	EB3C-R08CAN	280
		Common Wiring Only	Transistor (Sink/Source)	1	EB3C-T01AN	140
				2	EB3C-T02AN	170
				3	EB3C-T03AN	180
				5	EB3C-T05AN	250
				6	EB3C-T06AN	260
				8	EB3C-T08AN	320
				10	EB3C-T10AN	340
				8	EB3C-T08CKAN	260
Common Wiring Only	Transistor (Sink)	8	EB3C-T08CSAN	260		
		16	EB3C-T16CKAN	260		
	Transistor (Source)	8	EB3C-T08CSAN	260		
		16	EB3C-T16CSAN	260		
24V DC	Screw Terminal	Separate/Common Wiring Compatible	Relay	1	EB3C-R01DN	130
				2	EB3C-R02DN	170
				3	EB3C-R03DN	180
				5	EB3C-R05DN	250
				6	EB3C-R06DN	260
				8	EB3C-R08DN	260
				10	EB3C-R10DN	360
				8	EB3C-R08CDN	270
		Common Wiring Only	Transistor (Sink/Source)	8	EB3C-R16CDN	390
				1	EB3C-T01DN	120
				2	EB3C-T02DN	160
				3	EB3C-T03DN	170
				5	EB3C-T05DN	240
				6	EB3C-T06DN	250
				8	EB3C-T08DN	250
				10	EB3C-T10DN	320
	Common Wiring Only	Transistor	Sink	8	EB3C-T08CKDN	250
				16	EB3C-T16CKDN	350
			Source	8	EB3C-T08CSDN	250
				16	EB3C-T16CSDN	350
		Connector	Sink	16	EB3C-T16CKD-CN	330
				Source	16	EB3C-T16CSD-CN

Accessories

Name	Part No.	Ordering No.	Package Quantity	Description
DIN Rail	BAA1000	BAA1000PN10	10	Aluminum (1m long)
	BAP1000	BAP1000PN10	10	Steel (1m long)
End Clip	BNL6	BNL6PN10	10	For fastening EB3C units on the DIN rail.
Static Electricity Caution Plate	EB9Z-N1	EB9Z-N1PN10	10	Polyester 20 (W) x 6 (H) mm

Explosion-Protection and Electrical Specifications

Explosion Protection		Intrinsic safety type		
Degree of Protection		IP20 (IEC60529)		
Installation Location	Relay Barrier	Safe indoor place (safe area: non-hazardous area)		
	Switch	For zone 0, 1, 2 hazardous areas		
Non-intrinsically Safe Circuit Maximum Voltage (Um)		250V AC		
Intrinsically Safe Circuits	Wiring Method	1-channel Separate Wiring	16-channel Common Wiring	
	Rated Operating Voltage	12V DC $\pm 10\%$		
	Rated Operating Current	10 mA DC $\pm 20\%$		
	Maximum Output Voltage (Uo)	13.2V DC		
	Maximum Output Current (Io)	14.2 mA	227.2 mA	
	Maximum Output Power (Po)	46.9 mW	750 mW	
	Maximum External Capacitance (Co) (Note 1)	470 nF (470 nF)	490 nF (365 nF)	
	Maximum External Inductance (Lo) (Note 2)	87.5 mH (87.5 mH)	0.6 mH (0.425 mH)	
	Allowable Wiring Resistance (Rw)	300 Ω	600/(N+1) Ω (N = number of common channels)	
	Maximum Channels per Common Line	–	16	
Non-intrinsically Safe Circuits	Relay Output	Contact Configuration	1NO	
		Rated Insulation Voltage (Ui)	250V AC, 125V DC	
		Thermal Current (Ith)	3A (common terminal: 8A)	
		Contact Allowable Power	Resistive Load	AC: 750 VA, DC: 72W
			Inductive Load	AC: 750 VA (cos $\phi = 0.3$ to 0.4) DC: 48W (L/R = 7 ms)
		Rated Load	Resistive Load	250V AC 3A, 24V DC 3A
			Inductive Load	250V AC 3A (cos $\phi = 0.3$ to 0.4) 24V DC 2A (L/R = 7 ms)
		Minimum Applicable Load	0.1V DC, 0.1 mA (reference value)	
		Contact Resistance	50 m Ω maximum (initial value)	
		Turn ON Time	12 ms maximum (rated voltage)	
	Turn OFF Time	10 ms maximum (rated voltage)		
	Mechanical Life	20,000,000 operations minimum (at 18,000 operations/hour, without load)		
	Electrical Life	100,000 operations minimum (at 1,800 operations/hour, rated load)		
	Short-circuit Protection	None		
	Transistor Output	Rated Voltage	24V DC	
		Maximum Voltage	30V DC	
		Maximum Current	100 mA (connector model: 15 mA)	
Leakage Current		0.1 mA maximum		
Voltage Drop		1.5 V maximum		
Clamping Voltage		33V (1W)		
Inrush Current		0.5A maximum (1 sec)		
Turn ON Time		0.1 ms maximum (resistive load)		
Turn OFF Time	0.4 ms (typical) (resistive load)			
Short-circuit Protection	None			

Note: Values in () are those approved by TIIS (Technology Institution of Industrial Safety, Japan).

Certification No.

Certification Organization	Explosion Protection	Certification No.
FM	Class I, II, III Div. 1 Group A, B, C, D, E, F, G	3047250
	Class I, Zone 0 AEx [ia] II C	
UL	Class I, II, III, Div. 1 Group A, B, C, D, E, F, G	E234997
	Class I, Zone 0 AEx [ia] II C	
PTB (ATEX)	[Exia] II C: Gas, Vapour [Exia] III C: Dust	PTB09 ATEX2046
PTB (IECEx)	[Exia] II C: Gas, Vapour [Exia] III C: Dust	IECEx PTB10.0015
CQST	[Exia Ga] II C	CNEx14.0047
KCS	[Exia] II C	14-AV4B0-0373
TIIS	Relay barrier:[Exia] II C	TC20539
	Switch (EB9Z-A): Exia II CT6 Switch (EB9Z-A1): Exia II BT6	TC15758 TC15961
NK	[Exia] II C	Type Test No. 13T606
KR	[Exia] II C	TYK17821-EL003

Note: For details about switches, see "Switch Explosion-Protection Specifications" on page 6 and "3. Switches in the Hazardous Area" on page 10.

General Specifications

Power Voltage	AC Power	DC Power
Rated Power Voltage	100 to 240V AC	24V DC
Allowable Voltage Range	-15 to +10%	$\pm 10\%$
Rated Frequency	50/60 Hz (allowable range: 47 to 63 Hz)	—
Inrush Current	10A (100V AC) 20A (200V AC)	10A
Dielectric Strength (1 minute, 1 mA)	Between intrinsically safe circuit and non-intrinsically safe circuit: 1526.4V AC	
	Between AC power and output terminal: 1500V AC Between DC power and transistor output terminal: 1000V AC (screw terminal model only)	
Operating Temperature	-20 to +60°C (no freezing)	
Storage Temperature	-20 to +60°C (no freezing)	
Operating Humidity	45 to 85% RH (no condensation)	
Atmosphere	800 to 1100 hPa	
Pollution Degree	2 (IEC60664)	
Insulation Resistance	10 M Ω minimum (500V DC megger, between the same poles as the dielectric strength)	
Vibration Resistance (damage limits)	Panel mounting: 10 to 55 Hz, amplitude 0.75 mm	
	DIN rail mounting: 10 to 55 Hz, amplitude 0.35 mm	
Shock Resistance (damage limits)	Panel mounting: 500 m/s ² (3 times each on X, Y, Z)	
	DIN rail mounting: 300 m/s ² (3 times each on X, Y, Z)	
Terminal Style	M3 screw terminal	
Mounting	35-mm-wide DIN rail or panel mounting (M4 screw)	
Power Consumption (approx.)	9.6 VA (EB3C-R10AN at 200V AC)	
	4.8W (EB3C-R16CDN at 24V DC)	

Switch Explosion-Protection Specifications (Japan only)

Simple apparatuses in accordance with relevant standards of each country can be installed in the hazardous area and connected to the EB3C located in the safe area. In Japan, any switches, though regarded as simple apparatuses, must be certified for explosion-proof devices. EB9Z-A and EB9Z-A1 are IDEC's generic Part No. of any single apparatuses certified by TIIS for use with the EB3C, therefore simple apparatuses with specifications shown below can be used as those approved by the Japanese explosion-proof certification.

Switch Part No.	EB9Z-A	EB9Z-A1
Explosion Proof (Note 1)	Exia II CT6	Exia II BT6
Operating Temperature	-20 to +60°C (no freezing)	
Operating Humidity	45 to 85% RH (no condensation)	
Degree of Protection	IP20	
Dielectric Strength	500V AC, 1 mA	
Intrinsic Safety Ratings and Parameters	1-channel Separate Wiring Maximum input voltage (Ui): 13.2V Maximum input current (Ii): 14.2 mA Maximum input power (Pi): 46.9 mW Internal capacitance (Ci): ≤ 2 nF Internal inductance (Li): ≤ 5 μH	16-channel Common Wiring Maximum input voltage (Ui): 13.2V Maximum input current (Ii): 227.2 mA Maximum input power (Pi): 750 mW Internal capacitance (Ci): ≤ 32 nF Internal inductance (Li): ≤ 80 μH
Enclosure Material	Metallic: Magnesium content must be 7.5% or less (steel and aluminum are acceptable) Plastic: Switch operator exposed area IIC: 20 cm ² maximum IIB: 100 cm ² maximum When the switch has a wider exposed area, attach a caution label as shown at right.	
Switch Ratings (Note 2)	Contact rating: Ui, Ii minimum Contact resistance: 0.5Ω maximum Cross sectional area of wire: 0.000962 mm ² minimum Printed circuit board: Thickness 0.5 mm minimum Copper foil width 0.15 mm minimum Thickness 18 μm minimum one/both side(s) A resistor to prevent contact welding and an LED can be connected to 1-channel separate wiring circuits. Consult IDEC for details.	

Caution
 To prevent electrostatic charges, do not rub the switch surface during operation. Use a soft cloth dipped with water for cleaning.
Caution Label Example

Note 1: See "Precautions for Operation" on page 10.

Note 2: For details, see "3. Switches in the Hazardous Area" on page 10.

Internal Circuit Block Diagram

AC Power, Relay Output

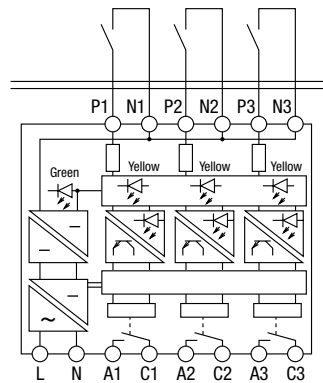

DC Power, Transistor Output

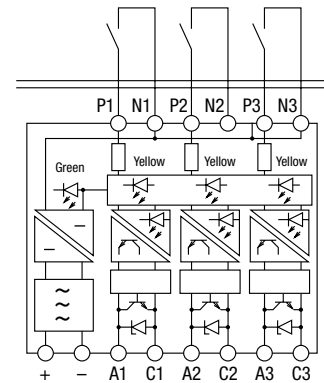

Connector Wiring, Sink Output

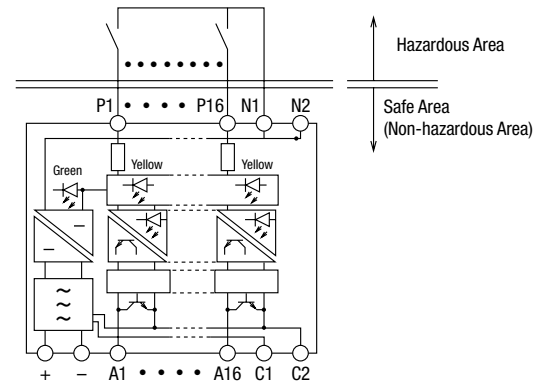

Dimensions

Connector Model

EB3C-T16C□-CN

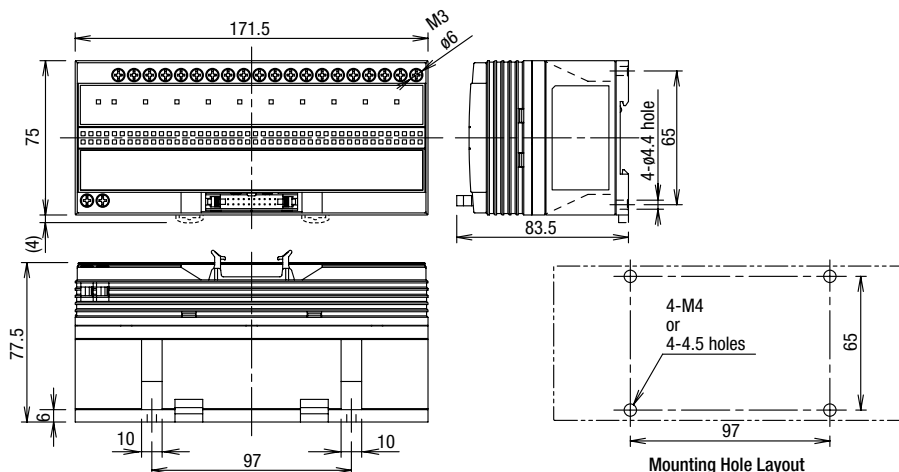

Applicable Crimping Terminal

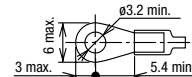

Stripping the Wire End

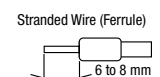
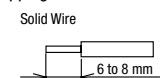

All dimensions in mm.

Screw Terminal

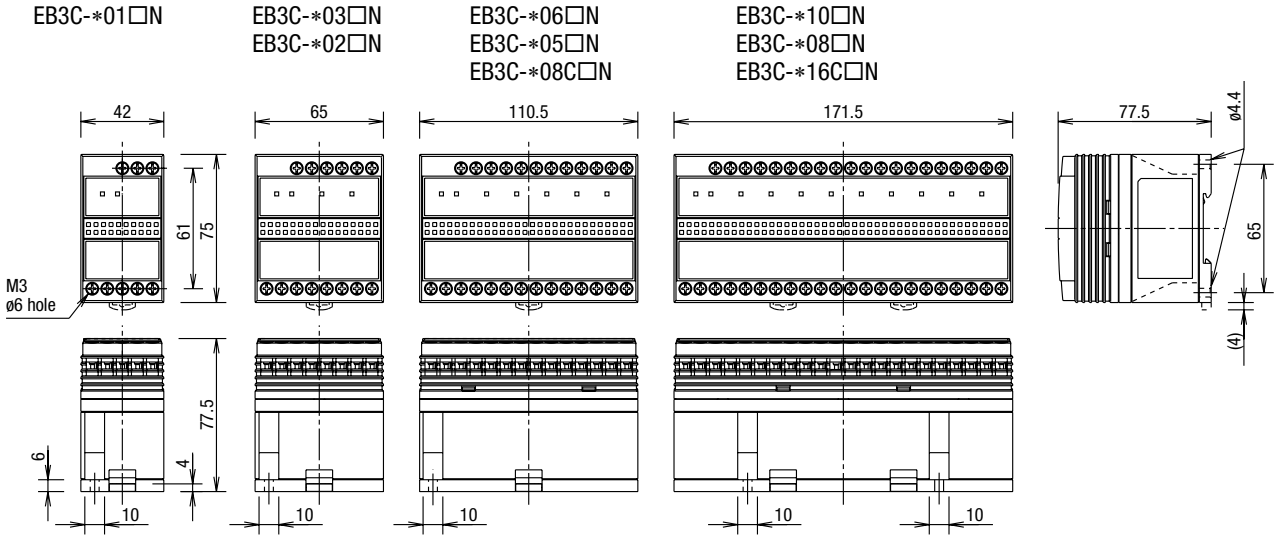

Mounting Hole Layout (Screw Mounting)

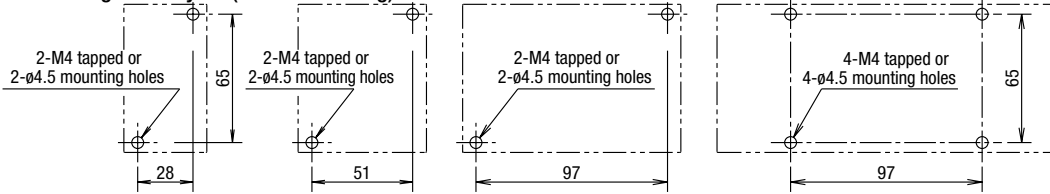

External Wiring Examples

Transistor Output (Ex.: EB3C-T06AN)

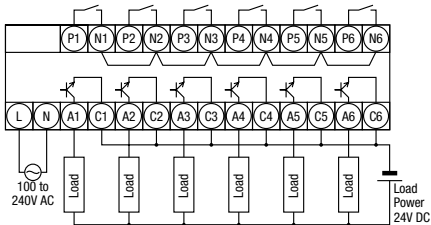

Note: On the sink/source transistor output model, terminals A can be used as a positive common line.

Transistor Sink Output (Ex.: EB3C-T08CKDN)

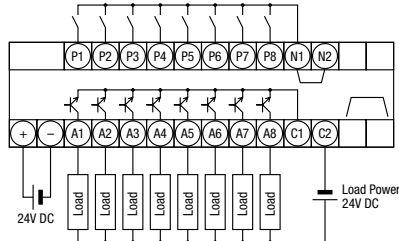

Transistor Source Output (Ex.: EB3C-T08CSDN)

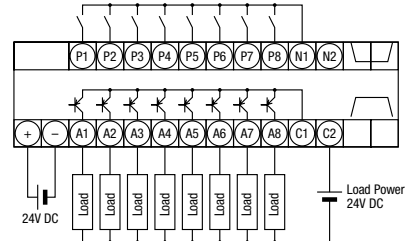

Relay Output (Ex.: EB3C-R06AN)

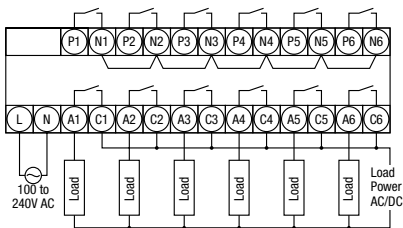

Relay Output Common Wiring (Ex.: EB3C-R16CDN)

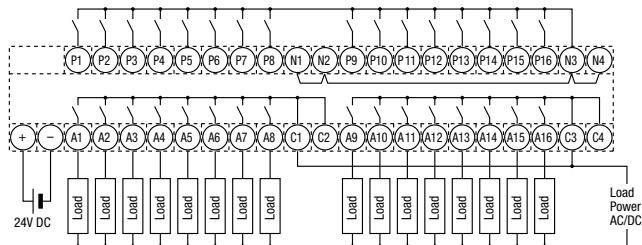

Connector Model Output Wiring Diagram

EB3C-T16CKD-CN (Sink)

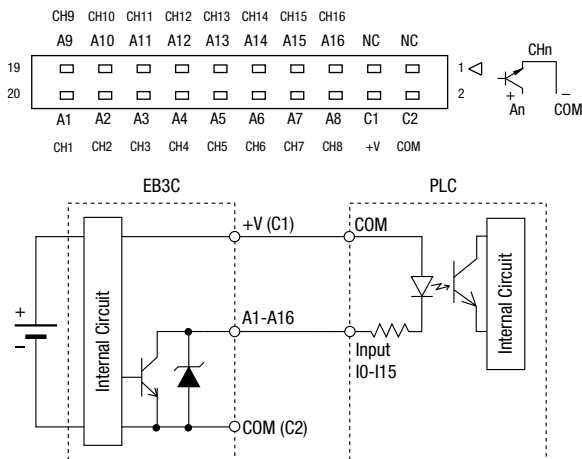

Wiring Example with IDEC's MicroSmart PLC Input Modules

EB3C-T16CKD-CN		FC4A-N16B3		EB3C-T16CSD-CN		FC4A-N16B3	
Terminal	Output	Input	Terminal	Terminal	Output	Input	Terminal
20	A1	I0	20	20	A1	I0	20
19	A9	I10	19	19	A9	I10	19
18	A2	I1	18	18	A2	I1	18
17	A10	I11	17	17	A10	I11	17
16	A3	I2	16	16	A3	I2	16
15	A11	I12	15	15	A11	I12	15
14	A4	I3	14	14	A4	I3	14
13	A12	I13	13	13	A12	I13	13
12	A5	I4	12	12	A5	I4	12
11	A13	I14	11	11	A13	I14	11
10	A6	I5	10	10	A6	I5	10
9	A14	I15	9	9	A14	I15	9
8	A7	I6	8	8	A7	I6	8
7	A15	I16	7	7	A15	I16	7
6	A8	I7	6	6	A8	I7	6
5	A16	I17	5	5	A16	I17	5
4	+V	COM	4	4	-V	COM	4
3	NC	COM	3	3	NC	COM	3
2	COM	NC	2	2	COM	NC	2
1	NC	NC	1	1	NC	NC	1

Note: The wiring in dashed line does not affect the operation of the EB3C.

Applicable connector is IDEC's JE1S-201.

Input power for PLC inputs is supplied by the EB3C, therefore the PLC input does not need an external power supply.

EB3C-T16CSD-CN (Source)

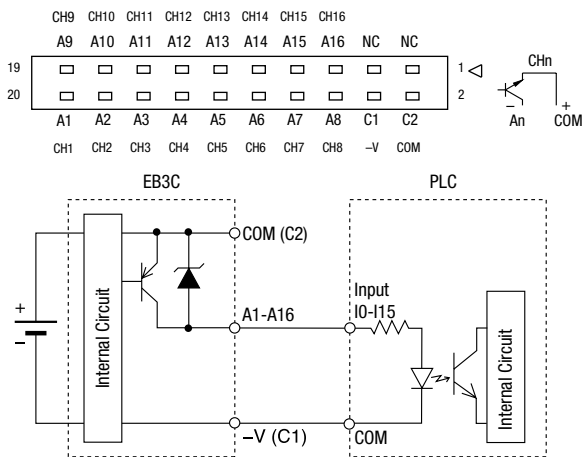

Wiring Example of Intrinsically Safe External Inputs

Common Wiring (Maximum 16 circuits)

All input lines are wired to a common line inside the intrinsically safe switch (one common line per intrinsically safe circuit).

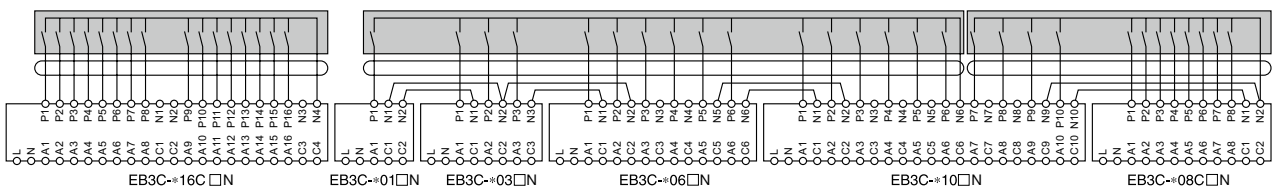

Some input lines are wired to a common line inside the intrinsically safe switches, while others are outside switches (one common line per intrinsically safe circuit).

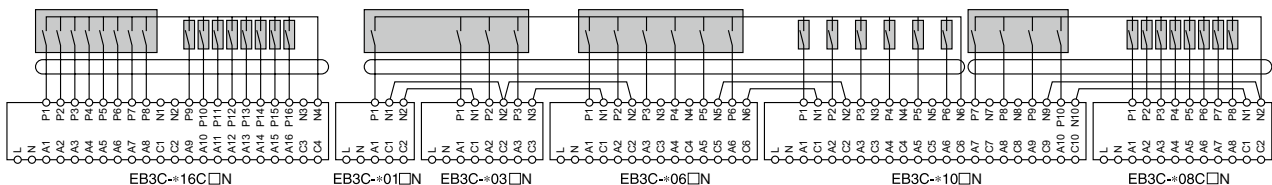

All input lines are wired to a common line outside the intrinsically safe switch (one common line per intrinsically safe circuit).

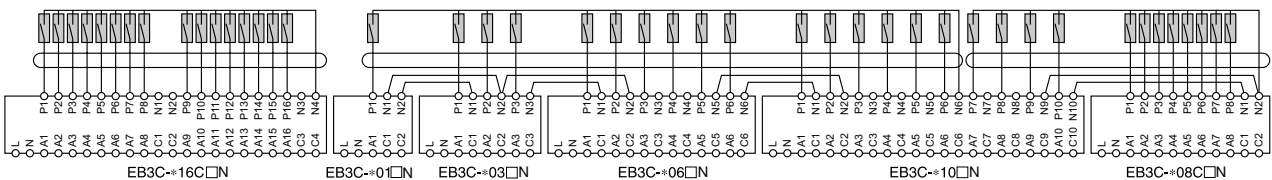

2. Separate Wiring

Each input line of the EB3C makes up one independent intrinsically safe circuit.

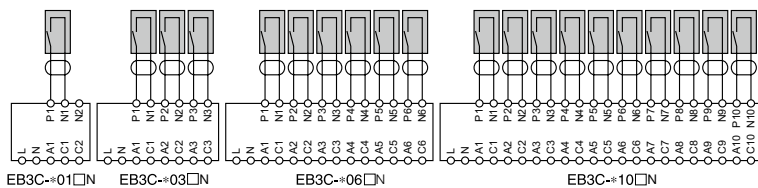
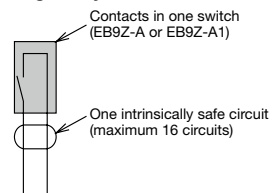
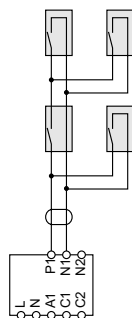

Diagram Symbols



Serial-Parallel Connection of Switches



Notes

- As shown in the diagram on the left, a required number of “contacts in one switch” (3 contacts in the example at left) can be added to the “contacts in one switch” connected to one input channel.
- Similarly, a required number of “contacts in one switch” can be added to a common line connected to multiple input channels.
- The capacitance and inductance of the added “contacts in one switch” must be included in the calculation of the wiring capacitance and inductance in “Precautions for Operation, 5. Wiring for Intrinsic Safety, (7)” on page 11.
- In addition, a required number of contacts can be added in the enclosure of “contacts in one switch.” In this case, however, do not include the capacitance and inductance in the calculation of the wiring capacitance and inductance on page 11. Instead, make sure that the internal capacitance (Ci) and internal inductance (Li) are within the values shown in the table “Switch Explosion-Protection Specifications (Japan only)” on page 6.

Recommended Connector Cable for Connector Models

Description		No. of Poles	Length (m)	Part No.	Shape	Applicable Model
I/O Terminal Cable	With Shield	20	0.5	FC9Z-H050A20		IDEC MicroSmart I/O Module
			1	FC9Z-H100A20		
			2	FC9Z-H200A20		
	Without Shield		0.5	FC9Z-H050B20		IDEC MicroSmart I/O Module
			1	FC9Z-H100B20		
			2	FC9Z-H200B20		
Cable with Crimping Terminal			1	BX9Z-H100E4		Screw Terminal
			2	BX9Z-H200E4		
			3	BX9Z-H300E4		
40-pin Cable for PLC			1	BX9Z-H100L		Mitsubishi A Series Input Module (positive common) ↓ EB3C-T16CKD-CN
			2	BX9Z-H200L		
			3	BX9Z-H300L		

FC9Z-H□□□A, FC9Z-H□□□B Internal Connection

Fujitsu Connector FCN-367J024-AU/F

IDEC Connector JE1S-20111

IDEC Connector JE1S-201

Y-shaped Compression Terminal (Marking Tube No.)

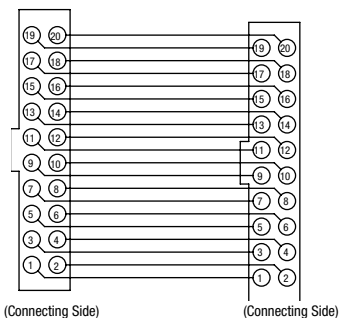

BX9Z□□□E4 Internal Connection

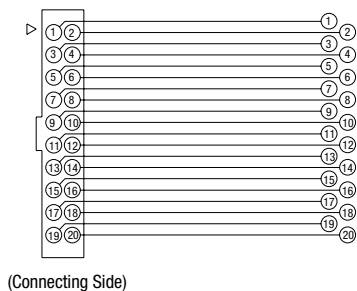

BX9Z-H□□□L Internal Connection

Fujitsu Connector FCN-367J040-AU/F

Connector A IDEC JE1S-201

Connector B IDEC JE1S-201

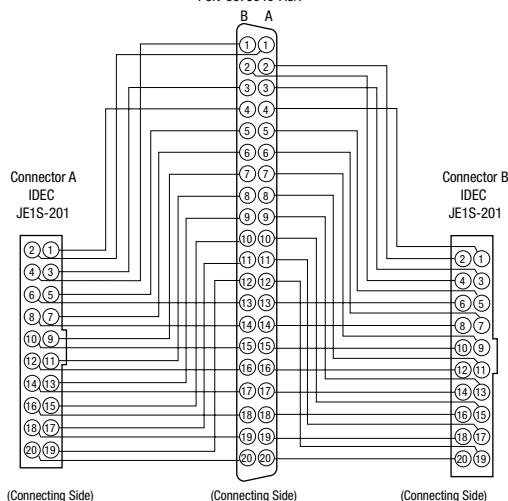

Operating Instructions

1. Installation of EB3C Relay Barriers

- (1) The EB3C can be installed in any direction.
- (2) Install the EB3C relay barrier in a safe area (non-hazardous area) in accordance with intrinsic safety ratings and parameters. To avoid mechanical shocks, install the EB3C in an enclosure which suppresses shocks.
- (3) When installing or wiring the EB3C, prevent electromagnetic and electrostatic inductions in the intrinsically safe circuit. Also prevent the intrinsically safe circuits from contacting with another intrinsically safe circuit and any other circuits.

Maintain at least 50 mm clearance, or provide a metallic separating board between the intrinsically safe circuit and non-intrinsically safety circuit. When providing a metallic separating board, make sure that the board fits closely to the enclosure (top, bottom, and both sides). Allowable clearance between the enclosure and board is 1.5 mm at the maximum.

The clearance of 50 mm between the intrinsically safe circuit and non-intrinsically safe circuit may not be sufficient when a motor circuit or high-voltage circuit is installed nearby. In this case, provide a wider clearance between the circuits referring to 5 (3) "Minimum Parallel Distance between the Intrinsically Safe Circuit and Other Circuits."

- (4) In order to prevent contact between intrinsically safe circuits and non-intrinsically safe circuits, mount EB3C units with terminals arranged in the same direction.

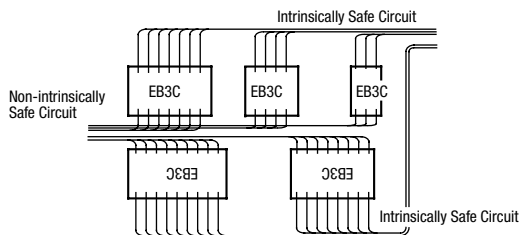

- (5) Maintain at least 6 mm (or 3 mm according to IEC60079-11: 1999) clearance between the terminal of intrinsically safe circuit and the grounded metal part of a metal enclosure, and between the relay terminal block of an intrinsically safe circuit and the grounded metal part of a metal enclosure.
- (6) For installing the EB3C, mount on a 35-mm-wide DIN rail or directly on a panel using screws. Make sure to install securely to withstand vibration. When mounting on a DIN rail, push in the clamp completely. Use the BNL6 end clips on both sides of the EB3C to prevent from moving sideways.
- (7) Excessive extraneous noise may cause malfunction and damage to the EB3C. When extraneous noise activates the voltage limiting circuit (thyristor), remove the noise source and restore the power.

2. Terminal Wiring

- (1) Using a $\phi 5.5$ mm or smaller screw driver, tighten the terminal screws (including unused terminal screws) to a torque of 0.6 to 1.0 N·m (recommended value).
- (2) Make sure that IP20 is achieved when wiring. Use insulation tubes on bare crimping terminals.
- (3) To prevent disengaged wires from contacting with other intrinsically safe circuits, bind together the wires of one intrinsically safe circuit.
- (4) When the adjacent terminal is connected to another intrinsically safe circuit, provide an insulation distance of at least 6 mm.

Applicable Switches

Control Switches	Push-pull Switches	Pushbutton, Foot, Trigger, Rocker, Grip
	Twisting Switches	Rotary, Selector, Cam, Drum, Thumb wheel
	Lever and Slide Switches	Toggle, Multidirectional, Wobble stick, Lever, Slide switch
Sensing Switches	Displacement Switches	Microswitch, Limit, Magnetic proximity, Door, Reed, Mercury
	Level Switches	Liquid level
	Others	Pressure, Temperature

Note: For installation in hazardous areas and connection to the EB3C, use switches which are certified, approved, or considered to be simple apparatus in relevant standards in each country.

- (2) When the switch has internal wiring or lead wire, make sure that the values of internal inductance (Li) and capacitance (Ci) are within the certified values.
- (3) Enclose the switch contact's bare live part in an enclosure of IP20 or higher protection.
- (4) Depending on the explosion-protection specifications according to TIIS, the exposed area of plastic switch operator is limited as follows:
 - Exia II CT6 (EB9Z-A): 20 cm² maximum
 - Exia II BT6 (EB9Z-A1): 100 cm² maximum
- (5) Attach the certification mark supplied with the EB3C on the EB9Z-A or EB9Z-A1 switch (for Japan application).
- (6) When the switch operator of plastic enclosure has a wider exposed area than the following limits, attach a caution label as shown below.

II C: 20 cm² maximum
II B: 100 cm² maximum

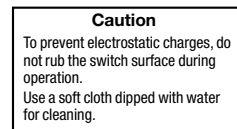

Caution Label Example

- (7) For the 1-circuit separate wiring, a resistor to prevent reed switch contact welding and an LED miniature pilot lights can be connected in series with the contact. See below. Use the terminal screw of M3 or larger.

Applicable Resistor Ratings

Resistance	100Ω maximum
Rated Wattage	0.5 to 3W
Model	Metal (oxide) film resistors

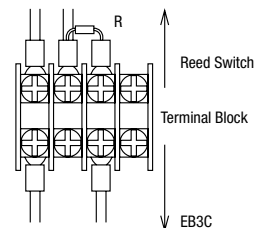

Applicable LED

IDEC's IPL1 series LED miniature pilot lights. See pages 14 and 17.

Operating Instructions

4. Output Specifications

(1) When wiring the output from the EB3C, connect the non-intrinsically safe circuit to terminals A and C. The EB3C output circuit is not equipped with short-circuit protection. If required, provide a protection in the external circuit.

(2) Relay Output

Some types of loads generate reverse emf (such as solenoids) or cause a large inrush current (incandescent lamps), resulting in a shorter operation life of output relay contacts. The operation life of contacts can be extended by preventing the reverse emf using a diode, RC, or varistor, or by suppressing the inrush current using a resistor or RL.

Contacts are made of gold-clad silver. When using at a small current and a low voltage (reference value: 0.1 mA, 0.1V), test the contact on the actual circuit in advance.

(3) Transistor Output

When connecting a small load, the load may not turn off because of a leakage current, even though the transistor output is turned off. If this is the case, connect a resistor in parallel with the load to bypass the leakage current.

When an excessively high voltage (clamps at 33V, 1W) or a reverse voltage is applied to the output terminals, the clamping circuit or output transistor may be damaged.

When driving an inductive load, be sure to connect a diode across the load to absorb reverse emf.

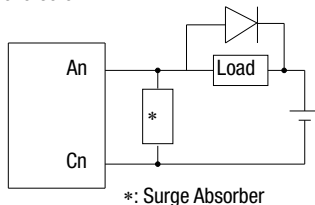

Example of Overvoltage Absorption Circuit

- (4) In the common wiring only models, the output terminals are not isolated from each other.
- (5) When connecting the connector model EB3C's in parallel, use one power supply to power the EB3C's. Do not connect any wiring to the C1 and C2 terminals.

5. Wiring for Intrinsic Safety

- (1) The voltage applied on the general circuit connected to the non-intrinsically safe circuit terminals of the EB3C relay barrier must be 250V AC, 50/60Hz, or 250V DC at the maximum under any conditions, including the voltage of the input power and the internal circuit.
- (2) When wiring, take into consideration the prevention of electromagnetic and electrostatic charges on intrinsically safe circuits. Also, prevent intrinsically safe circuits from contacting with other circuits.
- (3) The intrinsically safe circuits must be separated from non-intrinsically safe circuits. Contain intrinsically safe circuits in a metallic tube or duct, or separate the intrinsically safe circuits referring to the table below.

Note: Cables with a magnetic shield, such as a metallic sheath, prevent electromagnetic induction and electrostatic induction, however, a non-magnetic shield prevents electrostatic induction only. For non-magnetic shields, take a preventive measure against electromagnetic induction.

Finely twisted pair cables prevent electromagnetic induction. Adding shields to the twisted pair cables provides protection against electrostatic induction.

Minimum Parallel Distance between the Intrinsically Safe Circuit and Other Circuits (mm)

Voltage and Current of Other Circuits	Over 100A	100A or less	50A or less	10A or less
Over 440V	2000	2000	2000	2000
440V or less	2000	600	600	600
220V or less	2000	600	600	500
110V or less	2000	600	500	300
60V or less	2000	500	300	150

- (4) When identifying intrinsically safe circuits by color, use light blue terminal blocks and cables.
- (5) When using two or more EB3C's to set up one intrinsically safe circuit in the common wiring configuration, interconnect two neutral terminals (N1 through N10) on each EB3C between adjacent EB3C's in parallel.
- (6) Make sure that the power of the EB3C and contact are turned off before starting inspection or replacement.
- (7) When wiring the intrinsically safe circuit, determine the distance to satisfy the wiring parameters shown below. Note that parameters are different between separate wiring and common wiring.
 - a) Wiring capacitance $C_w \leq C_o - (C_i + N \times 2 \text{ nF})$
 Co: Maximum external capacitance of the EB3C
 Ci: Internal capacitance of the switch
 N: The number of switches connected in series or parallel (the number is infinite)
 - b) Wiring inductance $L_w \leq L_o - (L_i + N \times 5 \text{ } \mu\text{H})$
 Lo: Maximum external inductance of the EB3C
 Li: Internal inductance of the switch
 N: The number of switches connected in series or parallel (the number is infinite)
 - c) Wiring resistance $\leq R_w$
 Rw: Allowable wiring resistance
 - d) Allowable wiring distance D (km) is the smallest value of those calculated from the capacitance, inductance, and resistance.
 - $D \leq C_w/C$ C (nF/km): Capacitance of cable per km
 - $D \leq L_w/L$ L (mH/km): Inductance of cable per km
 - $D \leq R_w/2R$ R (Ω /km): Resistance of cable per km

Note: For the details of wiring the intrinsically safe circuits, refer to a relevant test guideline for explosion-proof electric equipment in each country.

(8) Applicable Wire Size

0.5 to 2.0 mm² (AWG20 to AWG14): two wires
 However, one wire for 2.0 mm² (AWG14)

Mounting Bracket

The following mounting brackets can be used to install the EB3C relay barriers and EB3L lamp barriers on the mounting holes of IBRC contact signal transducer, IBPL pilot relay barrier, and IBZ buzzer.

No. of Channels	Part No.	Dimension (mm)		
		A	B	C
1	EB9Z-K01	28.0	44.0	61.0
2	EB9Z-K02	51.0	59.5	76.0
3	EB9Z-K03	51.0	75.0	91.5
5	EB9Z-K05	97.0	105.0	122.0
6	EB9Z-K06	97.0	120.0	137.0
10	EB9Z-K10	97.0	181.0	198.0

Dimensions

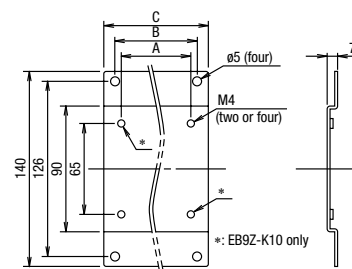

All dimensions in mm.

EB3L Lamp Barriers

126 types of pilot lights and buzzers can be connected and used in Zone 0 areas. Illuminated pushbuttons and illuminated selector switches can be connected by combining with the EB3C relay barrier.

Explosion protection	
Lamp Barrier	[Exia] II C
Pilot Light (separate wiring)	Exia II CT6
Pilot Light (common wiring)	Exia II CT4
Illuminated Pushbutton	Exia II CT4
Illuminated Selector Switch	Exia II CT4
Buzzer (separate wiring)*	Exib II CT6

- IEC60079 compliant.
- 8- and 16-channel are available in common wiring, ideal for connection to PLCs. 16-circuit also available with a connector.
- Universal AC power voltage (100 to 240V AC)
- No grounding required.
- IDEC's original spring-up terminal minimizes wiring time.
- Installation
35-mm-wide DIN rail mounting or direct screw mounting.
- $\phi 6$, $\phi 8$, $\phi 10$, $\phi 22$ and $\phi 30$ pilot lights available.
- Illuminated pushbuttons and illuminated selector switches can be connected by combining with the EB3C relay barrier.
Illumination colors: Amber, blue, green, red, white, and yellow (pushlock turn reset: red only)
- Buzzers are available in intermittent and continuous sounds. $\phi 30$ mounting hole.
- Global usage
IECEX
USA: FM, UL
Europe: CE marking, ATEX
China: CQST
Korea: KCS
Taiwan: TS
Japan: TIIS
- Ship class: NK (Japan), KR (Korea)

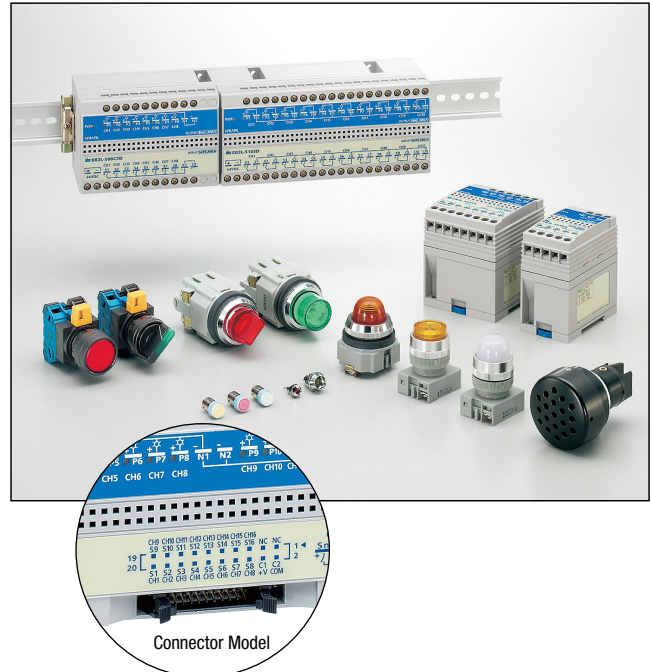

- * Buzzers are certified by TIIS only. Other ex-proof certifications pending.
- * Buzzers cannot be used in Zone 0 areas.

Lamp Barriers

Power Voltage	Connection to Non-intrinsically Safe Circuit	Input	Input Wiring Method (Note)	Number of Channels	Part No.	Weight (g)
100 to 240V AC	Screw Terminal	Source	Separate/Common Wiring Compatible	1	EB3L-S01SAN	150
				2	EB3L-S02SAN	180
				3	EB3L-S03SAN	190
				5	EB3L-S05SAN	250
				6	EB3L-S06SAN	260
				8	EB3L-S08SAN	330
				10	EB3L-S10SAN	360
				8 (*)	EB3L-S08CSAN	260
		Sink	Separate/Common Wiring Compatible	1	EB3L-S01KAN	150
				2	EB3L-S02KAN	180
				3	EB3L-S03KAN	190
				5	EB3L-S05KAN	250
				6	EB3L-S06KAN	260
				8	EB3L-S08KAN	330
				10	EB3L-S10KAN	360
				8 (*)	EB3L-S08CKAN	260
24V DC	Screw Terminal	Source	Separate/Common Wiring Compatible	1	EB3L-S01SDN	130
				2	EB3L-S02SDN	160
				3	EB3L-S03SDN	170
				5	EB3L-S05SDN	240
				6	EB3L-S06SDN	250
				8	EB3L-S08SDN	310
				10	EB3L-S10SDN	250
				8 (*)	EB3L-S08CSDN	340
		16 (*)	EB3L-S16CSDN	350		
		Sink	Separate/Common Wiring Compatible	1	EB3L-S01KDN	130
				2	EB3L-S02KDN	160
				3	EB3L-S03KDN	170
	5			EB3L-S05KDN	240	
	6	EB3L-S06KDN	250			
	8 (*)	EB3L-S08KDN	310			
	10	EB3L-S10KDN	340			
8	EB3L-S08CKDN	250				
16 (*)	EB3L-S16CKDN	350				
Connector	Source	Common Wiring Only	16 (*)	EB3L-S16CSD-CN	350	
			16 (*)	EB3L-S16CKD-CN	350	
	Sink		16 (*)	EB3L-S16CSD-CN	350	
			16 (*)	EB3L-S16CKD-CN	350	

* Buzzers cannot be connected in common wiring.

Note: Source input model can be connected with sink output PLC. Sink input model can be connected with source output PLC.

Accessories

Name	Part No.	Ordering No.	Package Quantity	Description
DIN Rail	BAA1000	BAA1000PN10	10	Aluminum (1m long)
	BAP1000	BAP1000PN10	10	Steel (1m long)
End Clip	BNL6	BNL6PN10	10	For fastening EB3L units on the DIN rail.

Pilot Lights, Illuminated Pushbuttons, Illuminated Selector Switches, and Buzzers

Unit	Size	Series (Note 1)	Shape	Operation Mode	Contact	Ordering No. (Note 2)	Lens Color/ Illumination Color Code*	Operation			
Pilot Light	ø30	N	Dome	—	—	EB3P-LAN1-*	A: Amber G: Green R: Red S: Blue W: White Y: Yellow	—			
			Square	—	—	EB3P-LUN3B-*					
			Rectangular w/Metal Bezel	—	—	EB3P-LUN4-*					
			Dome w/Diecast Sleeve	—	—	EB3P-LAD1-*					
	ø22	TW	Flush	—	—	EB3P-LAW1-*					
			Flush (Marking Type)	—	—	EB3P-LAW1B-*					
			Dome	—	—	EB3P-LAW2-*					
			Square Flush (Marking Type)	—	—	EB3P-LUW1B-*					
		HW	Round Flush	—	—	EB3P-LHW1-*					
			Dome	—	—	EB3P-LHW2-*					
			Square Flush	—	—	EB3P-LHW4-*					
		LW	Round	—	—	EB3P-LLW1-*					
			Square	—	—	EB3P-LLW2-*					
			Round w/Square Bezel	—	—	EB3P-LLW3-*					
			—	—	—	—			—	—	
Miniature Pilot Light	ø10	—	Extended	—	—	IPL1-18-*	A: Amber G: Green R: Red W: White Y: Yellow	—			
			Coned	—	—	IPL1-19-*					
			Flush	—	—	IPL1-87-*					
	ø8	UP	Extended	—	—	IPL1-88-*					
			Coned	—	—	IPL1-89-*					
			Flush	—	—	IPL1-67-*					
	ø6	—	Extended	—	—	IPL1-68-*					
			Coned	—	—	IPL1-69-*					
			—	—	—	—			—		
Illuminated Pushbutton	ø30	N	Extended	Momentary	1NO-1NC	EB3P-LBAN211-*	A: Amber G: Green R: Red S: Blue W: White Y: Yellow	(Note 3)			
				Maintained	1NO-1NC	EB3P-LBA0N211-*		(Note 4)			
			Mushroom	Pushlock Turn Reset	1NO-1NC	EB3P-LBAVN311-R		Red only	(Note 5)		
	ø22	TW	Extended	Momentary	1NO-1NC	EB3P-LBAW211-*		A: Amber G: Green R: Red S: Blue W: White Y: Yellow	(Note 3)		
				Maintained	1NO-1NC	EB3P-LBA0W211-			(Note 4)		
			Mushroom	Pushlock Turn Reset	1NO-1NC	EB3P-LBAVW411-R			Red only	(Note 5)	
		HW	Round	Momentary	1NO	EB3P-LBH1W110-*			(Note 3)		
				Maintained	1NO	EB3P-LBHA1W110-*			(Note 4)		
				Momentary	DPDT	EB3P-LBL1W1C2-*			(Note 3)		
	LW	Round	Maintained	DPDT	EB3P-LBLA1W1C2-*	(Note 4)					
			Momentary	DPDT	EB3P-LBL2W1C2-*	(Note 3)					
			Maintained	DPDT	EB3P-LBLA2W1C2-*	(Note 4)					
	Illuminated Selector Switch (Note 3)	ø30	N	Round	2-position	1NO-1NC			EB3P-LSAN211-*	A: Amber G: Green R: Red S: Blue W: White Y: Yellow	Maintained
					3-position	2NO			EB3P-LSAN320-*		Maintained
				ø22	TW	Round			2-position		1NO-1NC
2-position, return from right		1NO-1NC	EB3P-LSAW2111-*				Spring return from right				
3-position		2NO	EB3P-LSAW320-*				Maintained				
3-position, return from right		2NO	EB3P-LSAW3120-*				Spring return from right				
3-position, return from left		2NO	EB3P-LSAW3220-*				Spring return from left				
3-position, 2-way return		2NO	EB3P-LSAW3320-*				2-way spring return				
HW		Round	2-position	1NO-1NC	EB3P-LSHW211-*	Maintained					
			3-position	2NO	EB3P-LSHW320-*	Maintained					
			2-position	DPDT	EB3P-LSL1W2C2-*	Maintained					
LW		Round w/Square Bezel	3-position	DPDT	EB3P-LSL3W3C2-*	Maintained					
			—	—	—	—	—				
Buzzer		ø30	—	—	Continuous sound	—	EB3P-ZUN12CN	—	Approx. 3 Hz		
					Intermittent sound (approx. 3 Hz)	—	EB3P-ZUN12FN				

Note 1: Codes N, TW, HW, LW, and UP are the series names of IDEC's switches and pilot lights.

Note 2: Specify a color code in place of *.

Note 3: Momentary operation mode—the contact operates when the button is pressed. When the button is released, the contact goes back to the original position.

Note 4: Maintained operation mode—the contact operates when the button is pressed, and maintains the position even when the button is released.

Re-pressing the button releases the contact.

Note 5: Pushlock turn reset operation mode—the button is held depressed when pressed, and released by turning clockwise.

Note 6: Illuminated selector switches have a knob operator.

Note 7: Lamp barrier and relay barrier need to be connected when using the illuminated pushbutton and illuminated selector switch.

Accessories

Name	Ordering No.	Package Quantity	Remarks
LED Lamp	EB9Z-LDS1-*	1	Specify a color code in place of * in the Ordering No. A: amber, G: green, R: red, S: blue, W: white
Static Electricity Caution Plate	EB9Z-N1PN10	10	Polyester 20 (W) x 6 (H) mm

Note: Use a pure white (PW) LED lamp for yellow (Y) illumination.

Explosion-Protection and Electrical Specifications of Lamp Barrier

Explosion Protection		Intrinsic safety type	
Degree of Protection		IP20 (IEC60529)	
Installation Location	Lamp Barrier	Safe indoor place (non-hazardous area)	
	Pilot Light, Illuminated Switch	For zone 0, 1, 2 hazardous areas	
	Buzzer	For zone 1, 2 hazardous areas	
Non-intrinsically Safe Circuit Maximum Voltage (Um)		250V AC 50/60Hz, 250V DC	
Operation		Input ON, Output ON (1:1)	
Intrinsically Safe Circuits (Output)	Wiring Method	1-channel Separate Wiring	16-channel Common Wiring
	Rated Operating Voltage	12V DC	
	Rated Operating Current	10 mA DC ±20%	
	Maximum Output Voltage (Uo)	13.2V DC	
	Maximum Output Current (Io)	14.2 mA	227.2 mA
	Maximum Output Power (Po)	46.9 mW	750 mW
	Maximum External Capacitance (Co) (Note)	470 (470) nF	490 (365) nF
	Maximum External Inductance (Lo) (Note)	87.5 (87.5) mH	0.6 (0.425) mH
	Allowable Wiring Resistance (Rw)	200/(n+1)Ω (n = number of common channels)	
	Maximum Channels per Common Line	8 (16 maximum)	
Voltage and Current when Connecting Control Units		Pilot light: 3.5V, 8.5 mA Miniature pilot light: 2V, 10 mA Illuminated switch: 3.5V, 8.5 mA Buzzer: 6.5V, 5.5 mA	
Non-intrinsically Safe Circuits (Signal Input)		Rated voltage: 24V DC Rated current: 5 mA (connector model: 4 mA)	

Note: Values in () are those approved by TIIS (Technology Institution of Industrial Safety, Japan).

General Specifications of Lamp Barrier

Power Voltage Type	AC Power	DC Power
Rated Power Voltage	100 to 240V AC (-15 to +10%)	24V DC (±10%)
Allowable Voltage Range	85 to 264V AC	21.6 to 26.4V DC
Rated Frequency	50/60 Hz (allowable range: 47 to 63 Hz)	—
Inrush Current	10A (100V AC) 20A (200V AC)	10A
Dielectric Strength (1 minute, 1 mA)	Between AC power and signal input: 1500V AC Between intrinsically safe circuit and non-intrinsically safe circuit: 1526.4V AC (except for DC power and signal input)	
Operating Temperature	-20 to +60°C (no freezing)	
Storage Temperature	-20 to +60°C (no freezing)	
Operating Humidity	45 to 85% RH (no condensation)	
Atmosphere	800 to 1100 hPa	
Pollution Degree	2 (IEC60664)	
Insulation Resistance	10 MΩ minimum (500V DC megger, between the same poles as the dielectric strength)	
Vibration Resistance (damage limits)	Panel mounting: 10 to 55 Hz, amplitude 0.75 mm (2 hours each on X, Y, Z)	
	DIN rail mounting: 10 to 55 Hz, amplitude 0.35 mm (2 hours each on X, Y, Z)	
Shock Resistance (damage limits)	Panel mounting: 500 m/s ² (3 times each on X, Y, Z)	
	DIN rail mounting: 300 m/s ² (3 times each on X, Y, Z)	
Terminal Style	M3 screw terminal	
Mounting	35-mm-wide DIN rail or panel mounting (M4 screw)	
Power Consumption (approx.)	8.8 VA (EB3L-S10SAN at 200V AC) 5.2 W (EB3L-S16CSDN at 24V DC)	

General Specifications of Pilot Light, Illuminated Pushbutton, Illuminated Selector Switch, and Buzzer

Operating Temperature		-20 to +60°C (no freezing)
Operating Humidity		45 to 85% RH (no condensation)
Dielectric Strength (1 mA, 1 minute)		EB3P: 1000V AC IPL1: 500V AC (between intrinsically safe circuit and dead parts)
Insulation Resistance		10 MΩ minimum (500V DC megger, between the same poles as the dielectric strength)
Pilot Light and Miniature Pilot Light	Degree of Protection	IP65 (IEC60529) (except for terminals) EB3P-LU/IPL1: IP40
	Lens/Illumination Color	Pilot light: Amber, blue, green, red, white, yellow Miniature pilot light: Amber, green, red, white, yellow
Intrinsic Safety Ratings and Parameters	1-channel Separate Wiring Maximum input voltage (Ui): 13.2V Maximum input current (Ii): 14.2 mA Maximum input power (Pi): 46.9 mW Internal capacitance (Ci): ≤ 2 nF Internal inductance (Li): ≤ 5 μH	
	16-channel Common Wiring Maximum input voltage (Ui): 13.2V Maximum input current (Ii): 227.2 mA Maximum input power (Pi): 750 mW Internal capacitance (Ci): ≤ 32 nF Internal inductance (Li): ≤ 80 μH	
Illuminated Switch	Degree of Protection	IP65 (IEC60529) (except for terminals) EB3P-LSAW**: IP54
	Illumination Color	Amber, blue, green, red, white, yellow
	Contact Voltage/Current	12V DC ±10%, 10 mA ±20% (when connecting to the EB3C)
	Intrinsic Safety Ratings and Parameters	16-channel Common Wiring Maximum input voltage (Ui): 13.2V Maximum input current (Ii): 227.2 mA Maximum input power (Pi): 750 mW Internal capacitance (Ci): ≤ 32 nF Internal inductance (Li): ≤ 80 μH
Buzzer	Degree of Protection	IP20 (IEC60529) (except for terminals)
	Sound Volume	75 dB minimum (at 1 m)
	Sound Source	Piezoelectric oscillator (continuous or intermittent)
	Intrinsic Safety Ratings and Parameters	1-channel Separate Wiring Maximum input voltage (Ui): 13.2V Maximum input current (Ii): 14.2 mA Maximum input power (Pi): 46.9 mW Internal capacitance (Ci): ≤ 260 nF Internal inductance (Li): ≤ 80 mH
	Weight	100g

Note: Connect buzzers in separate wiring. Buzzers cannot be used in common wiring.

Certification No.

Certification Organization	Explosion Protection	Certification No.
FM	Class I, II, III Div. 1 Group A, B, C, D, E, F, G	3047250 (buzzer: pending)
	Class I, Zone 0 AEx [ia] II C	
UL	Class I, II, III Div. 1 Group A, B, C, D, E, F, G	E234997 (except buzzer)
	Class I, Zone 0 [AEx ia] II C	
PTB (ATEX)	Lamp barrier: [Exia] II C	PTB09 ATEX2046 Pending
	Buzzer: Exib II CT6	
CQST	Lamp barrier: [Exia Ga] II C	CNEX 14.0047 Pending
	Buzzer: Exib II CT6	
KCS	Lamp barrier: [Exia] II C	14-AV4B0-0375 Pending
	Buzzer: Exib II CT6	
TIIS	Lamp barrier: [Exia] II C	TC20541 TC16361 TC16360 TC16362 TC20797
	Pilot light/Miniature pilot light: (separate wiring): Exia II CT6	
	Pilot light/Miniature pilot light: (common wiring): Exia II CT4	
	Illuminated switch: Exia II CT4	
NK	Lamp barrier: [Exia] II C	Type Test No. 13T606 Pending
	Buzzer: Exib II CT6	
KR	Lamp barrier: [Exia] II C	TYK17821-EL003 Pending
	Buzzer: Exib II CT6	

Note: Illuminated switches, pilot lights, and miniature pilot lights are certified by TIIS and NK only. Other certification organizations regard these units as simple apparatus, and require no certification.
Buzzers are certified by TIIS only. Other ex-proof certifications pending.

Internal Circuit Block Diagram

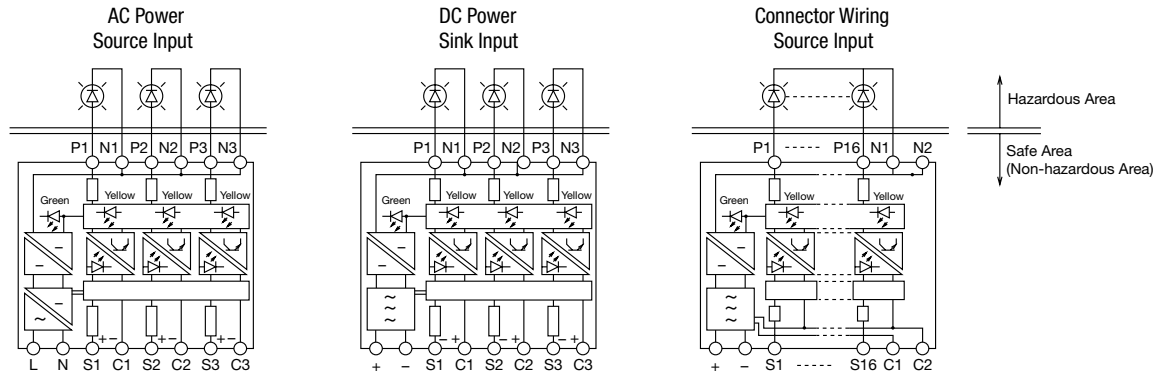

Dimensions

Terminal

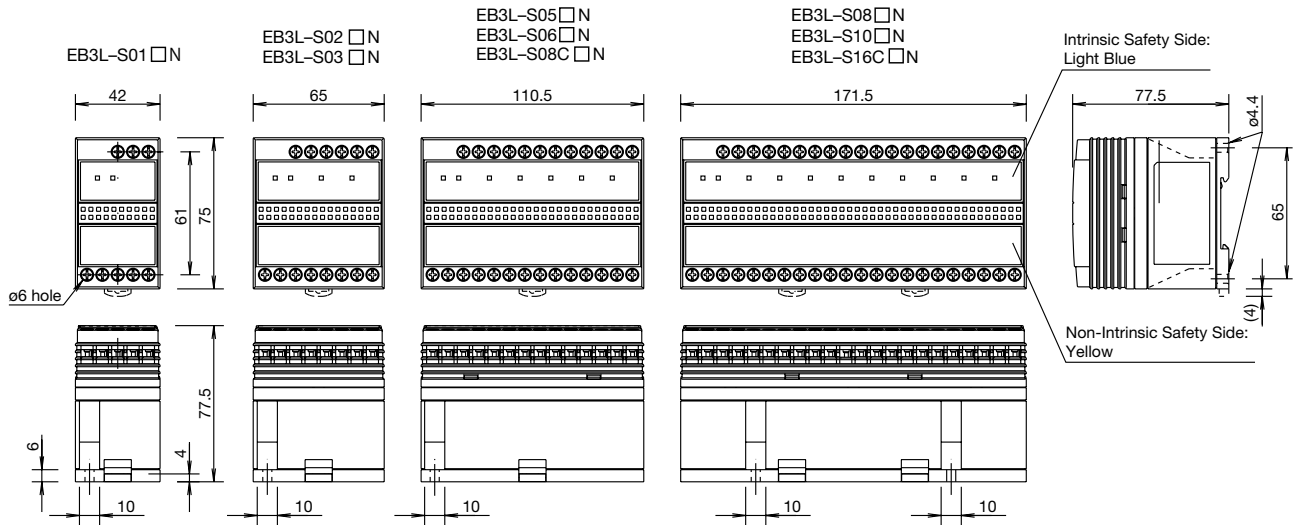

Mounting Hole Layout (Screw Mounting)

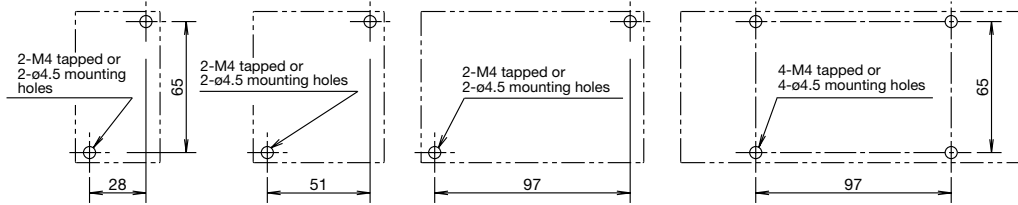

Connector

EB3L-S16C □ -CN

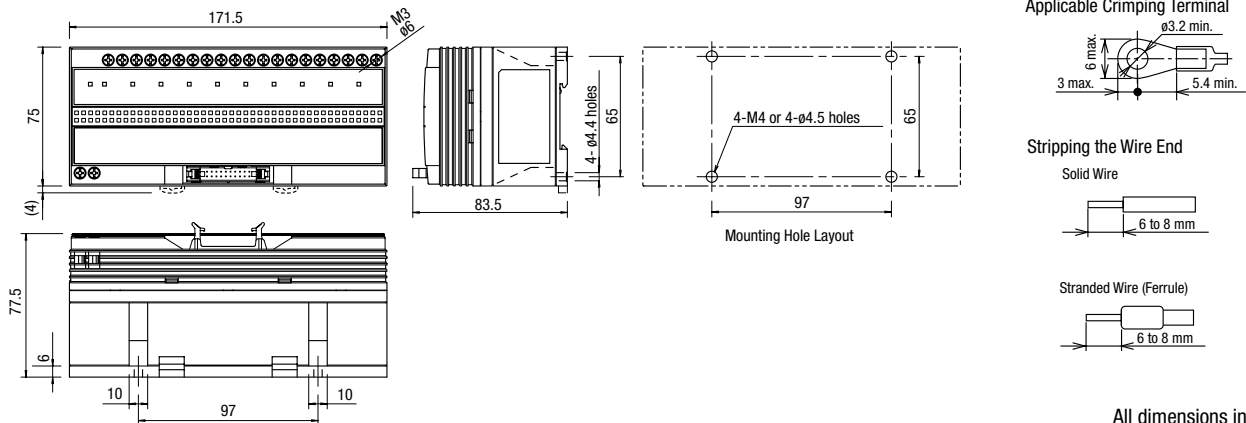

All dimensions in mm.

Pilot Lights

<p>ø30 EB3P-LAN1 Terminal Cover: APN-PVL (sold separately)</p>	<p>ø30 EB3P-LUN4 Terminal Cover: APN-PVL (sold separately)</p>	<p>ø30 EB3P-LAD Terminal Cover: APD-PVL (sold separately)</p>	<p>ø30 EB3P-LUN3B Terminal Cover: APN-PVL (sold separately)</p>
<p>ø22 EB3P-LAW1</p>	<p>ø22 EB3P-LAW1B</p>	<p>ø22 EB3P-LAW2</p>	<p>ø22 EB3P-LUW1B</p>
<p>ø22 EB3P-LHW1/EB3P-LHW2/EB3P-LHW4 Terminal cover attached.</p>		<p>ø22 EB3P-LLW1/EB3P-LLW2/EB3P-LLW3</p>	

Miniature Pilot Lights (Terminal cover not available)

<p>ø10 IPL1-18</p>	<p>ø10 IPL1-19</p>	<p>ø8 IPL1-87</p>	<p>ø8 IPL1-88</p>
<p>ø8 IPL1-89</p>	<p>ø6 IPL1-67</p>	<p>ø6 IPL1-68</p>	<p>ø6 IPL1-69</p>

Illuminated Pushbuttons

<p>ø30 EB3P-LBAN211/LBAON211 Terminal cover: N-VL4 (2 pcs.) (sold separately)</p>	<p>ø30 EB3P-LBAVN311-R Terminal cover: N-VL4 (2 pcs.) (sold separately)</p>	
<p>ø22 EB3P-LBAW211/LBAOW211 Terminal cover attached.</p>	<p>ø22 EB3P-LBAW411-R Terminal cover attached.</p>	<p>ø22 EB3P-LBH1W110/LBHA1W110 Terminal cover attached.</p>
<p>ø22 EB3P-LBL1W1C2/LBLA1W1C2 Terminal cover: LW-VL2M (sold separately)</p>	<p>ø22 EB3P-LBL2W1C2/LBLA2W1C2 Terminal cover: LW-VL2M (sold separately)</p>	

All dimensions in mm.

Illuminated Selector Switches

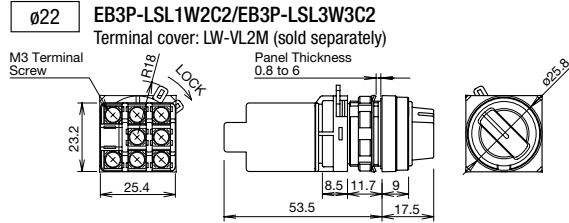
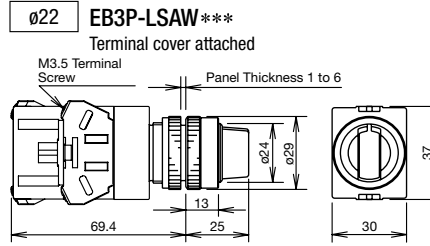
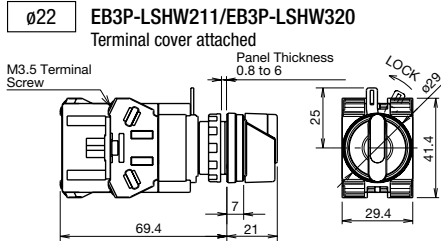
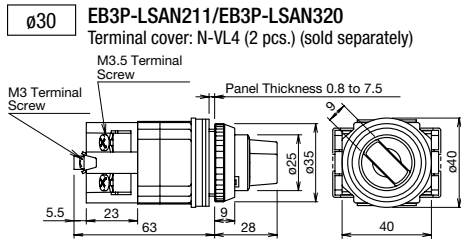

Buzzer

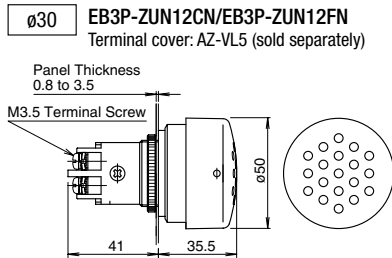

LED Lamp

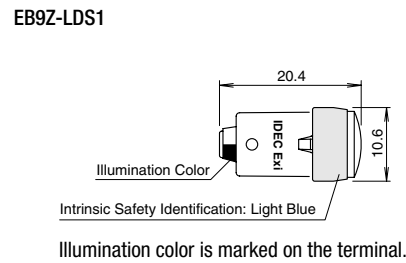

Polarity Identification

Pilot Lights/Illuminated Pushbuttons/Illuminated Selector Switches

- Positive terminal: X1
- Negative terminal: X2

Miniature Pilot Lights

- Positive terminal: Long pin terminal
- Negative terminal: Short pin terminal

Pin Terminals

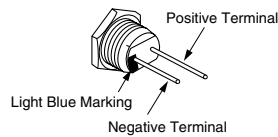

Buzzer

- Positive terminal: +
- Negative terminal: -

LED Lamp

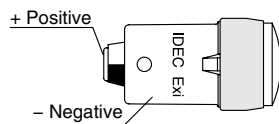

Panel Cut-out

Pilot Lights/Illuminated Pushbuttons/Illuminated Selector Switches/Buzzers

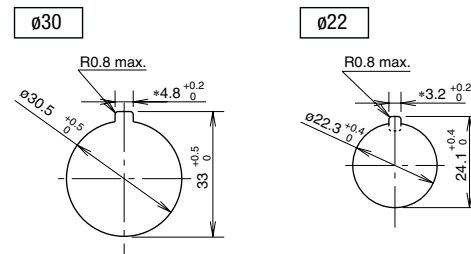

Miniature Pilot Lights

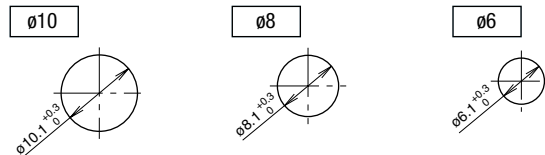

* The 4.8 or 3.2 recess is needed only when using an anti-rotation ring or a nameplate with an anti-rotation projection. EB3P-LHW does not have an anti-rotation groove.

Lamp Test

When checking the lamp lighting without using the EB3L lamp barrier, first make sure that the atmosphere is free from explosive gases. Connect a 12V DC power supply and a protection resistor of 1 kΩ in series to turn on the pilot light.

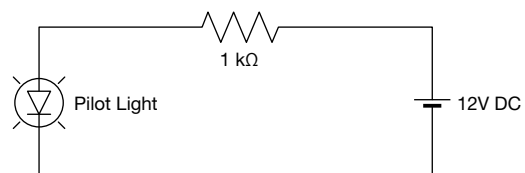

Non-intrinsically Safe External Input Wiring Examples

6-channel Source
(Ex.: EB3L-S06SAN)

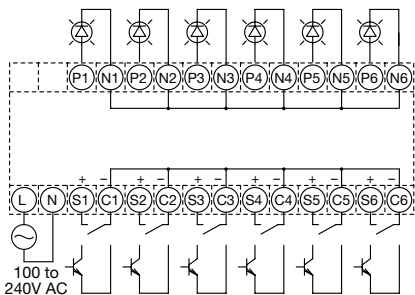

8-channel Common Wiring, Source
(Ex.: EB3L-S08CSDN)

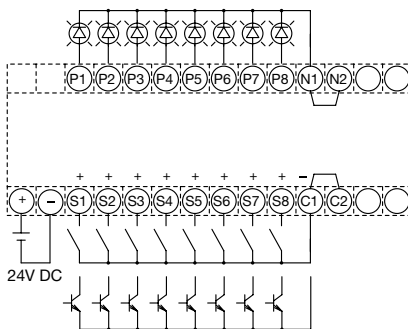

6-channel Sink
(Ex.: EB3L-S06KAN)

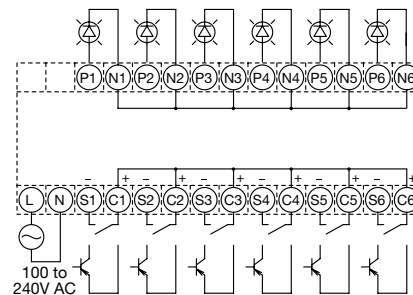

16-channel Common Wiring, Source
(Ex.: EB3L-S16CSDN)

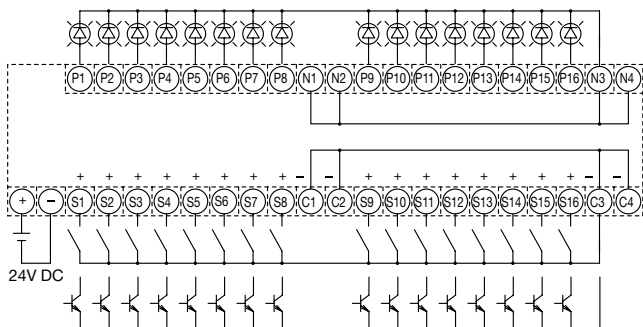

16-channel Common Wiring, Sink
(Ex.: EB3L-S16CKDN)

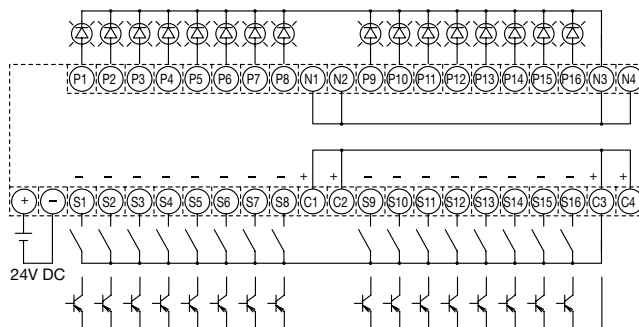

Note: Source input model can be connected to PLC sink output model
C terminal is the negative common line.

Note: Sink input model can be connected to PLC source output model
C terminal is the positive common line.

Connector Wiring Terminal Arrangement

EB3L-S16CSD-CN

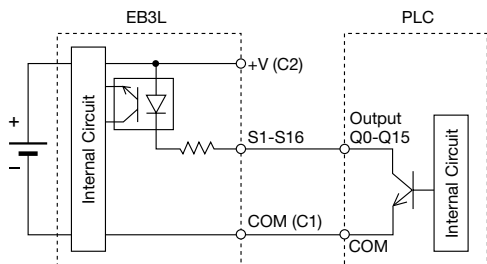
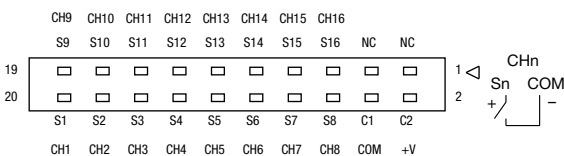

EB3L-S16CKD-CN

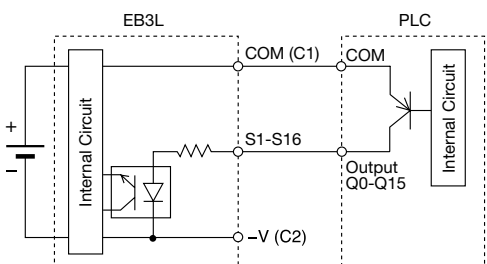
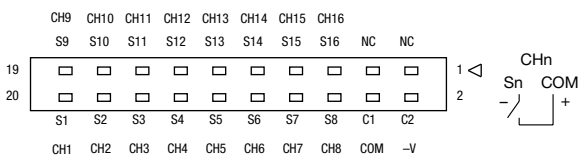

Wiring Example with IDEC's MicroSmart PLC Output Modules

FC4A-T16K3		EB3L-S16CSD-C		FC4A-T16S3		EB3L-S16CKD-C	
Terminal	Output	Input	Terminal	Terminal	Output	Input	Terminal
20	Q0	S1	20	20	Q0	S1	20
19	Q10	S9	19	19	Q10	S9	19
18	Q1	S2	18	18	Q1	S2	18
17	Q11	S10	17	17	Q11	S10	17
16	Q2	S3	16	16	Q2	S3	16
15	Q12	S11	15	15	Q12	S11	15
14	Q3	S4	14	14	Q3	S4	14
13	Q13	S12	13	13	Q13	S12	13
12	Q4	S5	12	12	Q4	S5	12
11	Q14	S13	11	11	Q14	S13	11
10	Q5	S6	10	10	Q5	S6	10
9	Q15	S14	9	9	Q15	S14	9
8	Q6	S7	8	8	Q6	S7	8
7	Q16	S15	7	7	Q16	S15	7
6	Q7	S8	6	6	Q7	S8	6
5	Q17	S16	5	5	Q17	S16	5
4	COM	COM	4	4	COM	COM	4
3	COM	NC	3	3	COM	NC	3
2	+V	+V	2	2	-V	-V	2
1	+V	NC	1	1	-V	NC	1

Note: The wiring in dashed line does not affect the operation of the EB3L.
Applicable connector is IDEC's JE1S-201.
Output power for PLC outputs is supplied by the EB3L, therefore the PLC output does not need an external power supply.

Wiring Example of Intrinsically Safe External Outputs

1. Common Wiring (Maximum 16 circuits) (Buzzers cannot be wired in a common line.)

All output lines are wired to a common line inside the intrinsically safe equipment (one common line per intrinsically safe circuit).

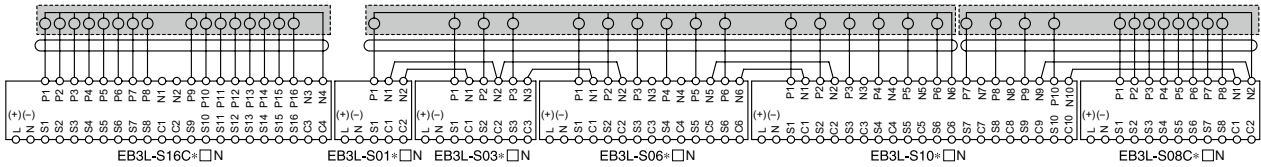

All input lines are wired to a common line outside the intrinsically safe equipment (one common line per intrinsically safe circuit).

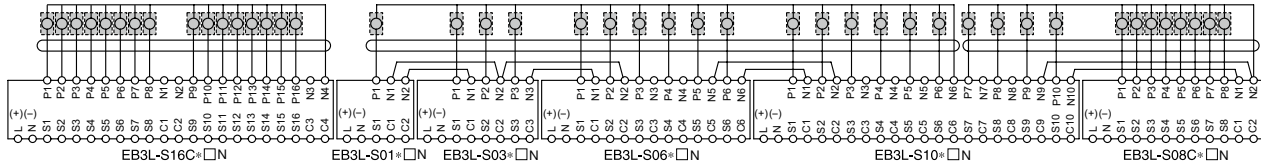

2. Separate Wiring

Each output line of the EB3L makes up one independent intrinsically safe circuit of a pilot light or buzzer.

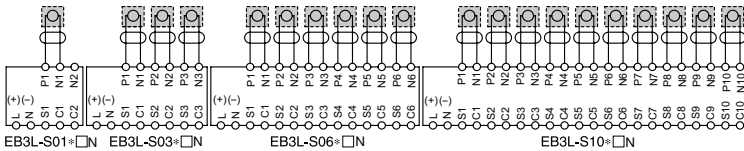

Note:
When using two or more EB3L's to set up one intrinsically safe circuit in the common wiring configuration, interconnect two neutral terminals (N1 through N10) on each EB3L between adjacent EB3L's in parallel.

3. Wiring Illuminated Pushbuttons and Illuminated Selector Switches

(A maximum of 16 channels of EB3L and EB3C can be wired to a common line.)

The following example illustrates the wiring for a total of 10 contacts used by three illuminated pushbuttons (LB1 to LB3) and three illuminated selector switches (LS1 to LS3).

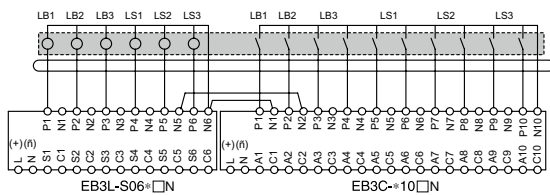
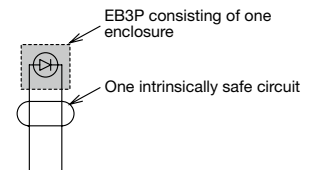

Diagram Symbols



One intrinsically safe circuit is a connection consisting of one or more illuminated units connected to a common line.

Recommended Connector Cable for Connector Models

Description		No. of Poles	Length (m)	Part No.	Shape	Applicable Model
I/O Terminal Cable	With Shield	20	0.5	FC9Z-H050A20		IDEC MicroSmart I/O Module
			1	FC9Z-H100A20		
			2	FC9Z-H200A20		
	Without Shield		0.5	FC9Z-H050B20		IDEC MicroSmart I/O Module
			1	FC9Z-H100B20		
			2	FC9Z-H200B20		
Cable with Crimping Terminal			1	BX9Z-H100E4		Screw Terminal
			2	BX9Z-H200E4		
			3	BX9Z-H300E4		
40-pin Cable for PLC			1	BX9Z-H100B		Mitsubishi A Series Output Module (sink) ↓ EB3L-S16CSD-CN
			2	BX9Z-H200B		
			3	BX9Z-H300B		

BX9Z-H□□□B Internal Connection

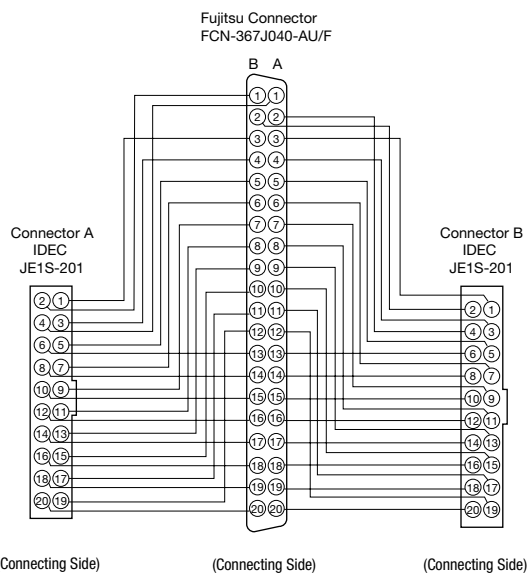

FC9Z-H□□□E Internal Connection

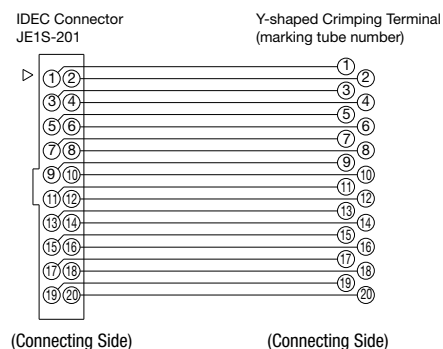

(Straight wire connection BX9Z-H□□□B: number of cable with crimping terminal)

FC9Z-H□□□A, FC9Z-H□□□B Internal Connection

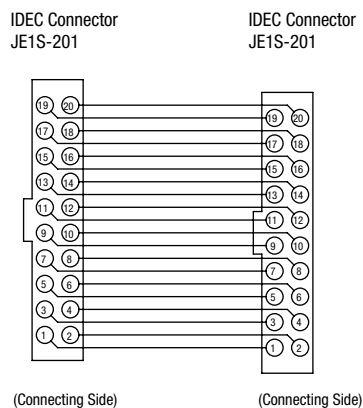

Operating Instructions

1. Installation of EB3L Lamp Barriers

- (1) The EB3L can be installed in any direction.
- (2) Install the EB3L lamp barrier in a safe area (non-hazardous area) in accordance with intrinsic safety ratings and parameters. To avoid mechanical shocks, install the EB3L in an enclosure which suppresses shocks.
- (3) When installing or wiring the EB3L, prevent electromagnetic and electrostatic inductions in the intrinsically safe circuit. Also prevent the intrinsically safe circuits from contacting with another intrinsically safe circuit and any other circuits.
 Maintain at least 50 mm clearance, or provide a metallic separating board between the intrinsically safe circuit and non-intrinsically safe circuit. When providing a metallic separating board, make sure that the board fits closely to the enclosure (top, bottom, and both sides). Allowable clearance between the enclosure and board is 1.5 mm at the maximum.
 The clearance of 50 mm between the intrinsically safe circuit and non-intrinsically safe circuit may not be sufficient when a motor circuit or high-voltage circuit is installed nearby. In this case, provide a wider clearance between the circuits referring to 6. (3) "Minimum Parallel Distance between the Intrinsically Safe Circuit and Other Circuits."
 (4) In order to prevent contact between intrinsically safe circuits and non-intrinsically safe circuits, mount EB3L units with terminals arranged in the same direction.

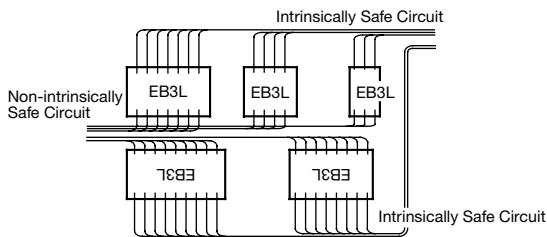

- (5) Maintain at least 6 mm (or 3 mm according to IEC60079-11: 1999) clearance between the terminal of intrinsically safe circuit and the grounded metal part of a metal enclosure, and between the relay terminal block of an intrinsically safe circuit and the grounded metal part of a metal enclosure.
- (6) For installing the EB3L, mount on a 35-mm-wide DIN rail or directly on a panel using screws. The EB3L can be installed in any direction. Make sure to install securely to withstand vibration. When mounting on a DIN rail, push in the clamp completely. Use the BNL6 end clips on both sides of the EB3L to prevent from moving sideways.
- (7) Excessive extraneous noise may cause malfunction and damage to the EB3L. When extraneous noise activates the voltage limiting circuit (thyristor), remove the noise source and restore the power.

2. Terminal Wiring

- (1) Using a $\phi 5.5$ mm or smaller screw driver, tighten the terminal screws (including unused terminal screws) to a torque of 0.6 to 1.0 N·m (recommended value).
- (2) Make sure that IP20 is achieved when wiring. Use insulation tubes on bare crimping terminals.
- (3) To prevent disengaged wires from contacting with other intrinsically safe circuits, bind together the wires of one intrinsically safe circuit.
- (4) When the adjacent terminal is connected to another intrinsically safe circuit, provide an insulation distance of at least 6 mm.

3. Signal Input

- (1) Connect the EB3L to the switches or output equipment which have a low leakage current (0.1 mA maximum).
- (2) The EB3L is equipped with power supply. Do not apply external power to the EB3L.
- (3) When connecting the EB3L's of connector model in parallel, make sure that the same power supply is used. When using C1 and C2 terminals to supply power to outside equipment, maintain the current at 50 mA maximum.

4. Power Voltage

- (1) Do not apply an excessive power voltage, otherwise the EB3L may be damaged.
- (2) The EB3L of AC power type may operate at a low voltage (approx. 20V).

5. Pilot Lights, Illuminated Switches, and Buzzers in the Hazardous Area

- (1) EB3P and IPL1 units shown on page 14 can be used with the EB3L. Buzzers cannot be connected in common wiring.
- (2) Install the EB3P and IPL1 units on enclosures of IP20 or higher protection. Use a metallic enclosure with magnesium content of 7.5% or less (steel and aluminum are acceptable).
- (3) When wiring, make sure of correct polarities of the EB3P and IPL1.
- (4) Certification mark is supplied with the units. Attach it on the visible area of the EB3P or IPL1 (for Japan application).
- (5) When connecting illuminated switches to the EB3L lamp barrier and the EB3C relay barrier, a maximum of 16 channels can be connected in common wiring.

Operating Instructions

6. Wiring for Intrinsic Safety

- (1) The voltage applied on the general circuit connected to the non-intrinsically safe circuit terminals of the EB3L lamp barrier must be 250V AC, 50/60Hz, or 250V DC at the maximum under any conditions, including the voltage of the power line and the internal circuit.
- (2) When wiring, take into consideration the prevention of electromagnetic and electrostatic charges on intrinsically safe circuits. Also, prevent intrinsically safe circuits from contacting with other circuits.
- (3) The intrinsically safe circuits must be separated from non-intrinsically safe circuits. Contain intrinsically safe circuits in a metallic tube or duct, or separate the intrinsically safe circuits referring to the table at right.

Note: Cables with a magnetic shield, such as a metallic sheath, prevent electromagnetic induction and electrostatic induction, however, a non-magnetic shield prevents electrostatic induction only. For non-magnetic shields, take a preventive measure against electromagnetic induction.

Finely twisted pair cables prevent electromagnetic induction. Adding shields to the twisted pair cables provides protection against electrostatic induction.

Minimum Parallel Distance between the Intrinsically Safe Circuit and Other Circuits (mm)

Voltage and Current of Other Circuits	Over 100A	100A or less	50A or less	10A or less
Over 440V	2000	2000	2000	2000
440V or less	2000	600	600	600
220V or less	2000	600	600	500
110V or less	2000	600	500	300
60V or less	2000	500	300	150

- (4) When identifying intrinsically safe circuits by color, use light blue terminal blocks and cables.
- (5) When using two or more EB3L's to set up one intrinsically safe circuit in the common wiring configuration, interconnect two neutral terminals (N1 through N10) on each EB3L between adjacent EB3L's in parallel.
- (6) Make sure that the power of the EB3L, pilot lights, and other connected units are turned off before starting inspection or replacement.

- (7) When wiring the intrinsically safe circuit, determine the distance to satisfy the wiring parameters shown below. Note that parameters are different between separate wiring and common wiring and depend on the connected units, such as pilot lights, illuminated pushbuttons, and buzzers.

- a) Wiring capacitance $C_w \leq C_o - C_i$
 C_o : Maximum external capacitance of the EB3L
 C_i : Internal capacitance of the connected unit
- b) Wiring inductance $L_w \leq L_o - L_i$
 L_o : Maximum external inductance of the EB3L
 L_i : Internal inductance of the connected unit
- c) Wiring resistance $\leq R_w$
 R_w : Allowable wiring resistance
- d) Allowable wiring distance D (km) is the smallest value of those calculated from the capacitance, inductance, and resistance.
 $D \leq C_w/C$ C (nF/km): Capacitance of cable per km
 $D \leq L_w/L$ L (mH/km): Inductance of cable per km
 $D \leq R_w/2R$ R (Ω /km): Resistance of cable per km

Note: For the details of wiring the intrinsically safe circuits, refer to a relevant test guideline for explosion-proof electric equipment in each country.

Safety Precautions

- Do not use the EB3C Relay Barrier and EB3L Lamp Barrier for other than explosion protection purposes.
- Read the user's manual to make sure of correct operation before starting installation, wiring, operation, maintenance, and inspection of the EB3C Relay Barrier and EB3L Lamp Barrier.

EB3N Safety Relay Barriers

Build a safety system in an explosive atmosphere.

Explosion Protection	Safety relay barrier	[Exia] II C	Safety Performance	Performance level e Category 4
	Switch (EB9Z-A)	Exia II CT6		
	Switch (EB9Z-A1)	Exia II BT6		

- Ensures explosion protection safety and machine safety in an explosive atmosphere.
- Machine safety system can be built in compliance with ISO13849-1 Category 4, Performance level e.
- Safety input devices applicable in any explosive gas and hazardous areas are available.
- Available with auxiliary inputs (5 points) used to monitor the operating status of safety input devices.
- A wide variety of Japan TIIS-rated emergency stop switches and interlock switches are available.
- Global usage
Explosion protection: Japan (TIIS), USA (UL), Europe (ATEX),
China (CQST), IEC Ex
Machine safety: TÜV Rheinland
- No grounding required.

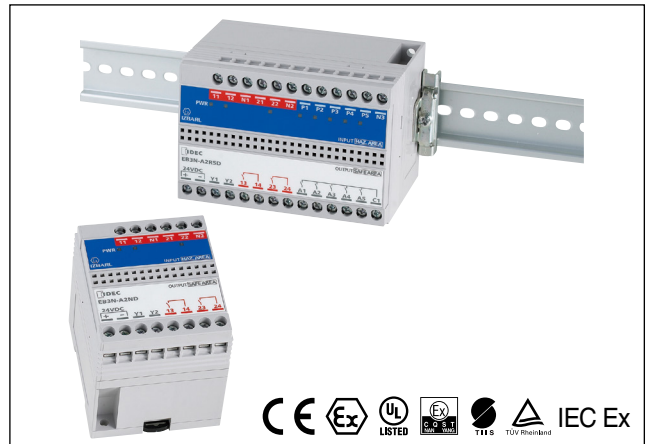

Safety Relay Barriers

Safety Input Points	Safety Output Points	Auxiliary Input Points (Note 1)	Auxiliary Output Points (Relay Output)	Reset (Start) (Note 2, Note 3)	Part No.
2	2NO	Without	Without	Auto reset (Auto start)	EB3N-A2ND
				Manual reset (Manual start)	EB3N-M2ND
2	2NO	5 (1 common)	5NO (1 common)	Auto reset (Auto start)	EB3N-A2R5D
				Manual reset (Manual start)	EB3N-M2R5D

Note 1: A maximum of five monitor contacts from safety input devices can be connected to the auxiliary input terminals. In addition, non-safety input devices can also be connected to the auxiliary input terminals.

Note 2: On auto reset (auto start) models, when the safety condition is met (two safety inputs are both on), safety outputs are turned on automatically.

Connect the reset (start) input terminals Y1 and Y2 together except for the following cases:

When connecting a contactor or force guided relay to the safety output of the EB3N, connect the NC contacts of the contactor or force guided relay to the reset (start) input terminals Y1 and Y2 of the EB3N for use as a backcheck input signal.

Note 3: On manual reset (manual start) models, while the safety condition is met (two safety inputs are both on), safety outputs are turned on at the falling edge of the reset switch (start switch) signal (OFF → ON → OFF) (start off check).

Manual reset (manual start) models have a monitoring function of reset switch contacts (detection of welded contacts). Use NO contacts of a momentary switch for the reset (start) input. When connecting a contactor or force guided relay to the safety output of the EB3N, connect the NC contacts of the contactor or force guided relay to the reset (start) input terminals Y1 and Y2 of the EB3N for use as a backcheck input signal.

Selection Guide

1. Selecting the reset (start) function

Auto reset (auto start): Select this model when connecting safety control devices, such as safety relay modules or safety controllers, to the EB3N safety outputs to set up a safety system, using the reset (start) function of the safety control device.

Select this model when connecting contactors or force guided relays to the EB3N safety outputs to set up a safety system, and a risk assessment on the entire system has not found any safety problem in using auto reset (auto start).

Manual reset (manual start): Select this model when connecting contactors or force guided relays to the EB3N safety outputs to set up a safety system, and a risk assessment on the entire system has found that manual reset (manual start) is necessary.

2. Selecting the auxiliary outputs

Without auxiliary outputs: Select this model when the operating status of safety input devices are not monitored.

With auxiliary outputs: Select this model when the operating status of safety input devices are monitored or when non-safety input devices are also connected.

General Specifications

Rated Power Voltage		24V DC	
Power Voltage Range		20.4 to 26.4V DC	
Operating Temperature		-20 to +60°C (no freezing) UL: -20 to +40°C (no freezing)	
Operating Humidity		45 to 85% RH (no condensation)	
Power Consumption	Without auxiliary output	5.5W maximum	
	With auxiliary output	7.0W maximum	
Safety Output	Contacts	13-14, 23-24	2NO
	Rated Load	Resistive	30V DC, 1A
		Inductive	DC-13, 24V, 1A
	Response (rated voltage)	Turn on	100 ms maximum
Turn off		20 ms maximum	
Auxiliary Output	Contacts	A* - C1	5NO/1 common
	Rated Load	Resistive	24V DC, 3A, common terminal 5A max.
		Inductive	
	Response (rated voltage)	Turn on	15 ms maximum
Turn off		10 ms maximum	
Mounting		DIN rail or panel mounting	

*: Channel Nos. 1 to 5

Explosion-Protection Specifications

Explosion Protection	[Exia] II C	
Non-intrinsically Safe Circuit Maximum Voltage (Um)	250V (UL: 125V)	
Intrinsically Safe Circuit Maximum Voltage (Uo)	13.2V	
Intrinsically Safe Circuit Maximum Current (Io)	227.2 mA	
Intrinsically Safe Circuit Maximum Power (Po)	750 mW	
Intrinsically Safe Circuit Allowable Capacitance (Co)	0.49 μF (TIIS: 0.28 μF)	
Intrinsically Safe Circuit Allowable Inductance (Lo)	0.60 mH	
	(TIIS: 0.56 mH)	
Intrinsically Safe Circuit Wiring Resistance (Rw)	Safety circuit	(Note 1)
	Auxiliary circuit	(Note 2)

Note 1: 10Ω maximum (500m maximum using a 1.25 mm² cable)

Note 2: 600/(N+1)Ω maximum, where N = the number of common channels

Safety Specifications

Category	4
Performance Level (PL)	e
Mean Time to Dangerous Failure (MTTFd)	100 years
Diagnostic Range	99% minimum

Calculation conditions for MTTFd

t_{cycle} : Mean operation cycle = 1 hour

h_{op} : Mean operation hours per day = 24 hours

d_{op} : Mean operation days per year = 365 days

Note: When t_{cycle} is shorter than 1 hour, MTTFd will decrease.

Certification No.

Certification Organization	Explosion Protection	Certification No.
TIIS	Safety Relay Barriers [Exia] II C Switch (EB9Z-A) [Exia] II CT6 Switch (EB9Z-A1) [Exia] II BT6	TC18753 TC15758 T15961
PTB	[Exia] II C, [Exia D] II (1) G [Exia] II C II (1) D [Exia D]	IEC Ex PTB 10.0015 PTB 09 ATEX 2046
CQST	[Exia] II C	CNEEx 11.0038
UL	Class I, Zone 0, [AExia] II C Class I, II, III, Div. 1, Grps A, B, C, D, E, F and G	E234997

Dimensions

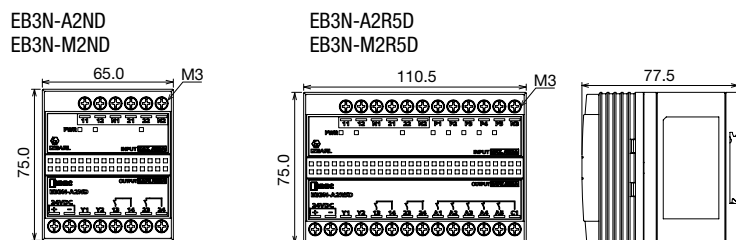

Mounting Hole Layout

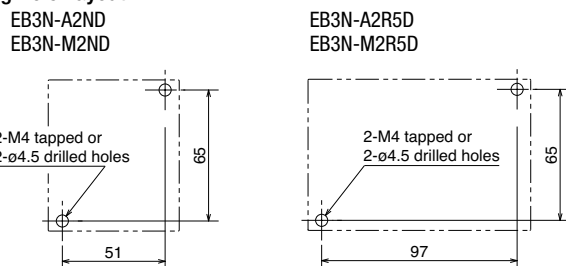

Terminal Functions

24V DC	Power
Y1-Y2	Reset input (Start input)
11-12	Safety input 1
21-22	Safety input 2
N1, N2	Signal ground
P*-N3	Auxiliary input
13-14	Safety output 1
23-24	Safety output 2
A*-C1	Auxiliary output

*: 1 to 5

EB3N System Configuration Examples

1:1 connection with a safety input device, compliant with Category 4

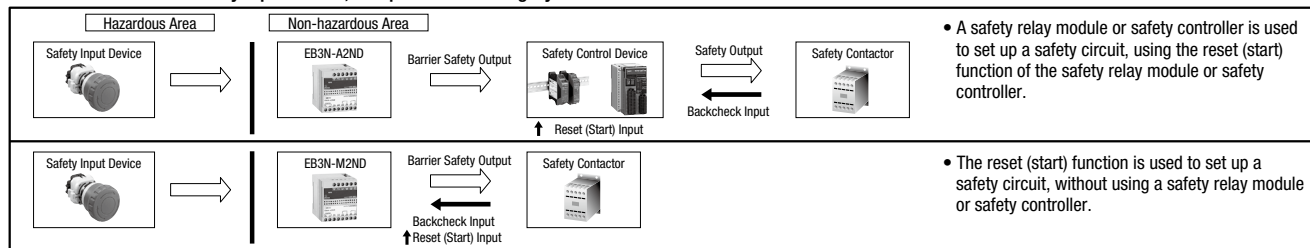

Connection with multiple safety input devices, capable of monitoring up to 5 contact operations, compliant with Category 3

For monitoring operating statuses of safety input devices located in a non-hazardous area

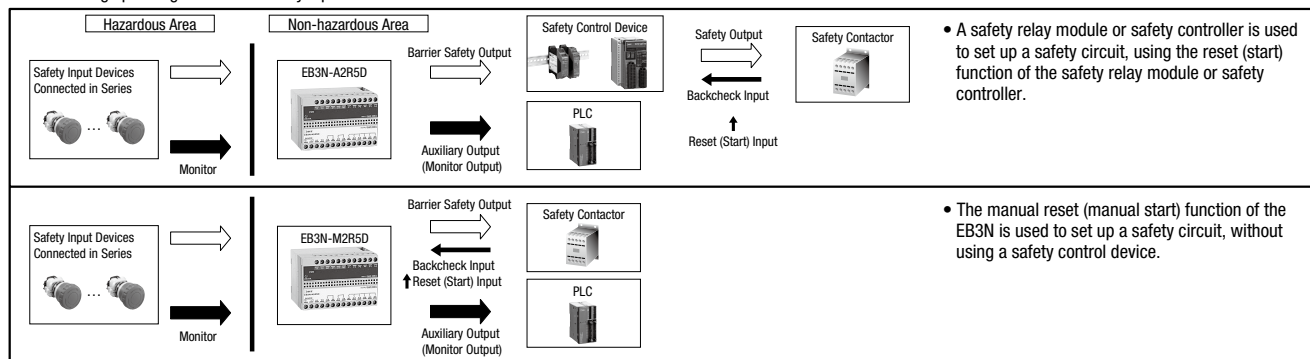

Installing a reset switch in a hazardous area, using auxiliary input and output

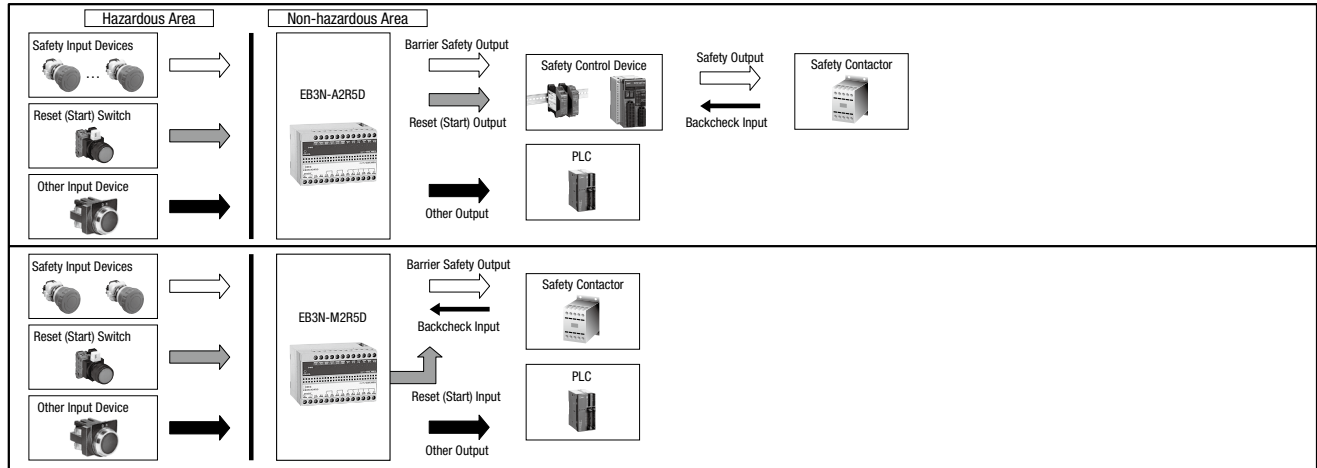

Safety Input Devices Connectable to Safety Input Terminals (Examples)

Emergency stop switch: (Non-illuminated) XW1E-BV402MFRH, XN4E-BL412MRH
 Safety switch: HS6B-02B05, HS1B-02R

Operating Instructions

Notes for Operation

- Do not disassemble, repair, or modify the EB3N safety relay barrier, otherwise the safety characteristics may be impaired.
- Use the EB3N within its specification values.
- The EB3N can be mounted in any direction.
- Mount the EB3N on a 35-mm-wide DIN rail or directly on a panel surface using screws. When mounting on a DIN rail, push in the clamp and use end clips to secure the EB3N. When mounting on a panel surface, tighten the screws firmly.
- Excessive noise may cause malfunction or damage to the EB3N. When the internal voltage limiting circuit (thyristor) has shut down the power due to noise, remove the cause of the noise before powering up again.
- The internal power circuit contains an electronic fuse to suppress overcurrents. When the electronic fuse has tripped, shut down the power, remove the cause of the overcurrent before powering up again.
- Use crimping terminals with insulation sheath for wiring. Tighten the terminal screws, including unused terminal screws, to a recommended tightening torque of 0.6 to N·m using a screwdriver of $\phi 5.5$ mm in diameter.
- Before inspecting or replacing the EB3N, turn off the power.

Notes for Machine Safety

- Operate the safety input device to check the EB3N functionality everyday.
- For safety input devices, such as safety switches or emergency stop switches, connected to the EB3N, use safety standard-compliant devices with direct opening action and 2NC contacts.
- Do not use the auxiliary input as a safety input.
- For safety control devices connected with the EB3N, use machine safety standard-compliant devices with a disparity detection function.
- Use safety inputs and safety outputs in a circuit configuration compliant with safety requirements.
- To calculate the safety distance, take into consideration the response time of all devices comprising the system, such as the EB3N and safety devices connected to the EB3N.
- Separate the input and output wiring from power lines and motor lines.
- When using multiple EB3N safety relay barriers, do not connect one switch to more than one EB3N. Use separate switches for each EB3N.
- To ensure EMC, use shielded cables for safety inputs and auxiliary inputs. Connect the shield to the FG of the control panel on which the EB3N is mounted.
- For protection against overcurrents, connect an IEC60127-2-compliant 2A fast-blow fuse (5×20 mm).
- Evaluate the ISO 13849-1 category and performance level in consideration of the entire system.

Notes for Explosion Protection Safety

- Install the EB3N in an enclosure capable of protecting against mechanical shocks at a hazardous location in accordance with intrinsic safety ratings and parameters.

- Install and wire the EB3N so that the EB3N is not subject to electromagnetic and electrostatic induction and does not contact with other circuits. For example, keep a minimum spacing of 50 mm between intrinsically safe and non-intrinsically safe circuits, or provide a metallic separating board between the intrinsically safe circuit and non-intrinsically safe circuit. When providing a metallic separating board, make sure that the board fits closely to the enclosure (top, bottom, and both sides). Allowable clearance between the board and the enclosure is 1.5 mm at the maximum. When a motor circuit or high-voltage circuit is installed nearby, keep a wider spacing than 50 mm between intrinsically safe and non-intrinsically safe circuits.
- Keep a minimum spacing of 3 mm between the terminal or relay terminal block of the intrinsically safe circuit and the grounded metal parts of the metal enclosure.
- Connect the terminals so that IP20 is ensured.
- To prevent disengaged wires from contacting with other intrinsically safe circuits, bind together the end of wires.
- Make sure that the voltage of the power supply for the devices connected to the non-intrinsically safe circuit or the internal voltage of such devices does not exceed 250V AC/DC 50/60 Hz or 250V DC under any normal and abnormal conditions.
- Make sure that the wiring of intrinsically safe circuits does not contact with other circuits or is not subject to electromagnetic and electrostatic inductions, otherwise explosion protection is not ensured.
- When identifying intrinsically safe circuits by color, use light blue terminal blocks and cables.
- When wiring the intrinsically safe circuit, determine the distance to satisfy the wiring parameters shown below.
 - Wiring capacitance $C_w \leq C_o - C_i$
 C_o : Intrinsically safe circuit allowable capacitance
 C_i : Internal capacitance of switches
 - Wiring inductance $L_w \leq L_o - L_i$
 L_o : Intrinsically safe circuit allowable inductance
 L_i : Internal inductance of switches
 - Wiring resistance $\leq R_w$
 R_w : Allowable wiring resistance

Switches in the Hazardous Area

- A switch contains the switch contact, enclosure, and internal wiring. A switch contact refers to an ordinary switching device which consists of contacts only.
- When the switch has internal wiring or lead wire, make sure that the values of internal capacitance (Ci) and inductance (Li) are within the certified values.
- Enclose the bare live part of the switch contact in an enclosure of IP20 or higher protection.
- Depending on the explosion-protection specifications of TIS, the exposed area of plastic switch operator, when installed in Japan, is limited as follows:

Certification	Explosion Protection	Exposed Area
TC15758	Exia II CT6	20 cm ² maximum
TC15961	Exia II BT6	100 cm ² maximum

IDEC CORPORATION

 www.idec.com

Head Office

6-64, Nishi-Miyahara-2-Chome, Yodogawa-ku, Osaka 532-0004, Japan

USA	IDEC Corporation	Tel: +1-408-747-0550	opencontact@idec.com	Hong Kong	IDEC Izumi (H.K.) Co., Ltd.	Tel: +852-2803-8989	info@hk.idec.com
Germany	IDEC Elektrotechnik GmbH	Tel: +49-40-25 30 54 - 0	service@eu.idec.com	China/Shanghai	IDEC (Shanghai) Corporation	Tel: +86-21-6135-1515	idec@cn.idec.com
Singapore	IDEC Izumi Asia Pte. Ltd.	Tel: +65-6746-1155	info@sg.idec.com	China/Shenzhen	IDEC (Shenzhen) Corporation	Tel: +86-755-8356-2977	idec@cn.idec.com
Thailand	IDEC Asia (Thailand) Co., Ltd	Tel: +66-2-392-9765	sales@th.idec.com	China/Beijing	IDEC (Beijing) Corporation	Tel: +86-10-6581-6131	idec@cn.idec.com
Australia	IDEC Australia Pty. Ltd.	Tel: +61-3-8523-5900	sales@au.idec.com	Japan	IDEC Corporation	Tel: +81-6-6398-2527	marketing@idec.co.jp
Taiwan	IDEC Taiwan Corporation	Tel: +886-2-2698-3929	service@tw.idec.com				

Specifications and other descriptions in this brochure are subject to change without notice.
2017 IDEC Corporation, All Rights Reserved.

EP1597-1 JANUARY 2018

